

STATE OF NORTH CAROLINA  
DEPARTMENT OF TRANSPORTATION  
HIGHWAY DIVISION 3

**PROPOSAL**

**DATE AND TIME OF BID OPENING:** June 20, 2024 AT 2:00 PM

**CONTRACT ID:** DC00459

**WBS ELEMENT NO.:** 46024.3.1

**FEDERAL AID NO.:** BRZ-1817(001)

**COUNTY:** Sampson County

**TIP NO.:** B-5310

**MILES:** .104

**ROUTE NO.:** SR 1817 (BRADSHAW ROAD)

**LOCATION:** SAMPSON BRIDGE 188 OVER WARD SWAMP ON SR 1817  
(BRADSHAW ROAD)

**TYPE OF WORK:** GRADING, DRAINAGE, PAVING AND STRUCTURE

**NOTICE:**

ALL BIDDERS SHALL COMPLY WITH ALL APPLICABLE LAWS REGULATING THE PRACTICE OF GENERAL CONTRACTING AS CONTAINED IN CHAPTER 87 OF THE GENERAL STATUTES OF NORTH CAROLINA WHICH REQUIRES THE BIDDER TO BE LICENSED BY THE N.C. LICENSING BOARD FOR CONTRACTORS WHEN BIDDING ON ANY NON-FEDERAL AID PROJECT WHERE THE BID IS \$30,000 OR MORE, EXCEPT FOR CERTAIN SPECIALTY WORK AS DETERMINED BY THE LICENSING BOARD. BIDDERS SHALL ALSO COMPLY WITH ALL OTHER APPLICABLE LAWS REGULATING THE PRACTICES OF ELECTRICAL, PLUMBING, HEATING AND AIR CONDITIONING AND REFRIGERATION CONTRACTING AS CONTAINED IN CHAPTER 87 OF THE GENERAL STATUTES OF NORTH CAROLINA. NOTWITHSTANDING THESE LIMITATIONS ON BIDDING, THE BIDDER WHO IS AWARDED ANY FEDERAL - AID FUNDED PROJECT SHALL COMPLY WITH CHAPTER 87 OF THE GENERAL STATUTES OF NORTH CAROLINA FOR LICENSING REQUIREMENTS WITHIN 60 CALENDAR DAYS OF BID OPENING.

THIS IS A STRUCTURE PROJECT.

BID BOND IS REQUIRED.

NAME OF BIDDER

ADDRESS OF BIDDER

**PROPOSAL FOR THE CONSTRUCTION OF  
CONTRACT No. DC00459 IN SAMPSON COUNTY, NORTH CAROLINA  
DEPARTMENT OF TRANSPORTATION,  
RALEIGH, NORTH CAROLINA**

The Bidder has carefully examined the location of the proposed work to be known as Contract No. **DC00459**; has carefully examined the plans and specifications, which are acknowledged to be part of the proposal, the special provisions, the proposal, the form of contract, and the forms of contract payment bond and contract performance bond; and thoroughly understands the stipulations, requirements and provisions. The undersigned bidder agrees to bound upon his execution of the bid and subsequent award to him by the Department of Transportation in accordance with this proposal to provide the necessary contract payment bond and contract performance bond within fourteen days after the written notice of award is received by him. The undersigned Bidder further agrees to provide all necessary machinery, tools, labor, and other means of construction; and to do all the work and to furnish all materials, except as otherwise noted, necessary to perform and complete the said contract in accordance with the *2024 Standard Specifications for Roads and Structures* by the dates(s) specified in the Project Special Provisions and in accordance with the requirements of the Engineer, and at the unit or lump sum prices, as the case may be, for the various items given on the sheets contained herein.

The Bidder shall provide and furnish all the materials, machinery, implements, appliances and tools, and perform the work and required labor to construct and complete Contract No. **DC00459** in **Sampson County**, for the unit or lump sum prices, as the case may be, bid by the Bidder in his bid and according to the proposal, plans, and specifications prepared by said Department, which proposal, plans, and specifications show the details covering this project, and hereby become a part of this contract.

The published volume entitled *North Carolina Department of Transportation, Raleigh, Standard Specifications for Roads and Structures, January 2024* with all amendments and supplements thereto, is by reference incorporated into and made a part of this contract; that, except as herein modified, all the construction and work included in this contract is to be done in accordance with the specifications contained in said volume, and amendments and supplements thereto, under the direction of the Engineer.

If the proposal is accepted and the award is made, the contract is valid only when signed either by the Contract Officer or such other person as may be designated by the Secretary to sign for the Department of Transportation. The conditions and provisions herein cannot be changed except over the signature of the said Contract Officer or Division Engineer.

The quantities shown in the itemized proposal for the project are considered to be approximate only and are given as the basis for comparison of bids. The Department of Transportation may increase or decrease the quantity of any item or portion of the work as may be deemed necessary or expedient.

An increase or decrease in the quantity of an item will not be regarded as sufficient ground for an increase or decrease in the unit prices, nor in the time allowed for the completion of the work, except as provided for the contract.

Accompanying this bid is a bid bond secured by a corporate surety, or certified check payable to the order of the Department of Transportation, for five percent of the total bid price, which deposit is to be forfeited as liquidated damages in case this bid is accepted and the Bidder shall fail to provide the required payment and performance bonds with the Department of Transportation, under the condition of this proposal, within 14 calendar days after the written notice of award is received by him, as provided in the *Standard Specifications*; otherwise said deposit will be returned to the Bidder.

**TABLE OF CONTENTS**

**COVER SHEET  
PROPOSAL SHEET**

**PROJECT SPECIAL PROVISIONS**

BOND REQUIREMENTS: ..... G-1  
 BUILD AMERICA, BUY AMERICA (BABA): ..... G-1  
 CONTRACT TIME AND LIQUIDATED DAMAGES: ..... G-1  
 INTERMEDIATE CONTRACT TIME NUMBER 1 AND LIQUIDATED DAMAGES: ..... G-2  
 PERMANENT VEGETATION ESTABLISHMENT: ..... G-3  
 MAJOR CONTRACT ITEMS: ..... G-3  
 SPECIALTY ITEMS: ..... G-4  
 FUEL PRICE ADJUSTMENT: ..... G-4  
 STEEL PRICE ADJUSTMENT: ..... G-5  
 SCHEDULE OF ESTIMATED COMPLETION PROGRESS: ..... G-17  
 DISADVANTAGED BUSINESS ENTERPRISE (DIVISIONS): ..... G-17  
 CERTIFICATION FOR FEDERAL-AID CONTRACTS: ..... G-31  
 RESTRICTIONS ON ITS EQUIPMENT AND SERVICES: ..... G-31  
 USE OF UNMANNED AIRCRAFT SYSTEM (UAS): ..... G-32  
 EQUIPMENT IDLING GUIDELINES: ..... G-32  
 U.S. DEPARTMENT OF TRANSPORTATION HOTLINE: ..... G-33  
 SUBSURFACE INFORMATION: ..... G-33  
 TWELVE MONTH GUARANTEE: ..... G-33  
 EROSION AND SEDIMENT CONTROL/STORMWATER CERTIFICATION: ..... G-34  
 PROCEDURE FOR MONITORING BORROW PIT DISCHARGE: ..... G-39

ROADWAY .....R-1

**STANDARD SPECIAL PROVISIONS**

AVAILABILITY OF FUNDS – TERMINATION OF CONTRACTS ..... SSP-1  
 NCDOT GENERAL SEED SPECIFICATION FOR SEED QUALITY ..... SSP-2  
 ERRATA ..... SSP-5  
 PLANT AND PEST QUARANTINES ..... SSP-6  
 TITLE VI AND NONDISCRIMINATION: ..... SSP-7  
 MINORITY AND FEMALE EMPLOYMENT REQUIREMENTS ..... SSP-16  
 REQUIRED CONTRACT PROVISIONS FEDERAL-AID CONSTR CONTRACTS ..... SSP-19  
 ON-THE-JOB TRAINING ..... SSP-33  
 MINIMUM WAGES ..... SSP-36

**UNIT PROJECT SPECIAL PROVISIONS**

EROSION CONTROL ..... EC-1  
 STRUCTURE/CULVERTS ..... ST-1

**PERMITS** ..... P-1

**PROPOSAL ITEM SHEET**

ITEM SHEET(S)

**INSTRUCTIONS TO BIDDERS****PLEASE READ ALL INSTRUCTIONS CAREFULLY  
BEFORE PREPARING AND SUBMITTING YOUR BID.**

**All bids shall be prepared and submitted in accordance with the following requirements. Failure to comply with any requirement may cause the bid to be considered irregular and may be grounds for rejection of the bid.**

For preparing and submitting the bid electronically, refer to Article 102-8(B) of the *Standard Specifications*.

Bidders that bid electronically on Raleigh Central-Let projects will need a separate Digital Signature from the approved electronic bidding provider for Division Contracts.

**ELECTRONIC ON-LINE BID:**

1. Download entire proposal from Connect NCDOT website. Download the electronic submittal file from the approved electronic bidding provider website.
2. In accordance with Article 102-3 of the Standard Specifications, registration on the Interested Parties List is required unless SP1 G02 Interested Parties List Not Required provision is included in the proposal.
3. Prepare and submit the electronic submittal file using the approved electronic bidding provider software.
4. Electronic bidding software necessary for electronic bid preparation may be downloaded from the Bid Express website following the directions at: <https://connect.ncdot.gov/letting/Pages/Electronic-Bidding.aspx>.
5. Questions should be emailed 7 calendar days prior to the bid opening to **Jonathan W. Mitchell** at **Jwmitchell1@ncdot.gov**. Contact with any other NCDOT personnel concerning this project is strictly prohibited, unless otherwise noted, and may result in bids being considered non-responsive.

**PROJECT SPECIAL PROVISIONS****GENERAL****BOND REQUIREMENTS:**

(6-1-16)(Rev.1-16-24)

102-8, 102-10

SPD 01-420A

A Bid Bond is required in accordance with Article 102-10 of the *Standard Specifications for Roads and Structures*.

Contract Payment and Performance Bonds are required in accordance with Article 103-7 of the *Standard Specifications*.

**BUILD AMERICA, BUY AMERICA (BABA):**

(11-15-22)(Rev. 1-16-24)

106

SP1 G04

Revise the *Standard Specifications* as follows:

**Page 1-48, Article 106-1 GENERAL REQUIREMENTS**, add the following after line 49:

**(C) Build America, Buy America (BABA)**

All manufactured products and construction materials permanently incorporated into any project must meet requirements of the Build America, Buy America (BABA) Act of the Infrastructure Investment and Jobs Act (IIJA). Before any material or product shown on the Department's Build America, Buy America (BABA) List is included for payment on a monthly estimate, the Contractor shall furnish the Engineer with a notarized certification certifying that the items conform to the BABA Act. The Department's Build America Buy America (BABA) List can be found on the Department's website.

<https://connect.ncdot.gov/letting/LetCentral/NC DOT%20BABA%20Materials%20List.pdf>

Each purchase order issued by the Contractor or a subcontractor for items on the BABA List to be permanently incorporated into any project shall contain in bold print a statement advising the supplier that the manufactured products and construction materials must be produced in the United States of America. The Contractor and all affected subcontractors shall maintain a separate file for BABA List items so that verification of the Contractor's efforts to purchase items produced in the United States can readily be verified by an authorized representative of the Department or the Federal Highway Administration (FHWA).

**CONTRACT TIME AND LIQUIDATED DAMAGES:**

(8-15-00) (Rev. 5-16-23)

108

SP1 G08 A

The date of availability for this contract is **August 1, 2024**, except that work in jurisdictional waters and wetlands shall not begin until a meeting between the DOT, Regulatory Agencies, and the Contractor is held as stipulated in the permits contained elsewhere in this proposal. This delay in availability has been considered in determining the contract time for this project.

The completion date for this contract is **September 8, 2025**.

Except where otherwise provided by the contract, observation periods required by the contract will not be a part of the work to be completed by the completion date and/or intermediate contract times stated in the contract. The acceptable completion of the observation periods that extend beyond the final completion date shall be a part of the work covered by the performance and payment bonds.

The liquidated damages for this contract are **Two Hundred Dollars (\$ 200.00)** per calendar day. These liquidated damages will not be cumulative with any liquidated damages which may become chargeable under Intermediate Contract Time Number 1.

**INTERMEDIATE CONTRACT TIME NUMBER 1 AND LIQUIDATED DAMAGES:**

(7-1-95) (Rev. 2-21-12)

108

SP1 G13 A

Except for that work required under the Project Special Provisions entitled *Planting, Reforestation* and/or *Permanent Vegetation Establishment*, included elsewhere in this proposal, the Contractor will be required to complete all work included in this contract and shall place and maintain traffic on same.

The date of availability for this intermediate contract time is **August 1, 2024**.

The completion date for this intermediate contract time is **March 3, 2025**.

The liquidated damages for this intermediate contract time are **Nine Hundred Dollars (\$ 900.00)** per calendar day.

Upon apparent completion of all the work required to be completed by this intermediate date, a final inspection will be held in accordance with Article 105-17 and upon acceptance, the Department will assume responsibility for the maintenance of all work except *Planting, Reforestation* and/or *Permanent Vegetation Establishment*. The Contractor will be responsible for and shall make corrections of all damages to the completed roadway caused by his planting operations, whether occurring prior to or after placing traffic through the project.

**PERMANENT VEGETATION ESTABLISHMENT:**

(2-16-12)(Rev. 1-16-24)

104

SP1 G16

Establish a permanent stand of the vegetation mixture shown in the contract. During the period between initial vegetation planting and final project acceptance, perform all work necessary to establish permanent vegetation on all erodible areas within the project limits, as well as, in borrow and waste pits. This work shall include erosion control device maintenance and installation, repair seeding and mulching, supplemental seeding and mulching, mowing, and fertilizer topdressing, as directed. All work shall be performed in accordance with the applicable section of the *Standard Specifications*. All work required for initial vegetation planting shall be performed as a part of the work necessary for the completion and acceptance of the Intermediate Contract Time (ICT). Between the time of ICT and Final Project acceptance, or otherwise referred to as the vegetation establishment period, the Department will be responsible for preparing the required National Pollutant Discharge Elimination System (NPDES) inspection records.

Once the Engineer has determined that the permanent vegetation establishment requirement has been achieved at an 80% vegetation density (the amount of established vegetation per given area to stabilize the soil) and no erodible areas exist within the project limits, the Contractor will be notified to remove the remaining erosion control devices that are no longer needed. The Contractor will be responsible for, and shall correct any areas disturbed by operations performed in permanent vegetation establishment and the removal of temporary erosion control measures, whether occurring prior to or after placing traffic on the project.

Payment for *Response for Erosion Control, Seeding and Mulching, Repair Seeding, Supplemental Seeding, Mowing, Fertilizer Topdressing, Silt Excavation, and Stone for Erosion Control* will be made at contract unit prices for the affected items. Work required that is not represented by contract line items will be paid in accordance with Articles 104-7 or 104-3 of the *Standard Specifications*. No additional compensation will be made for maintenance and removal of temporary erosion control items.

**MAJOR CONTRACT ITEMS:**

(2-19-02)(Rev. 1-16-24)

104

SP1 G28

The following listed items are the major contract items for this contract (see Article 104-5 of the *Standard Specifications*):

<b>Line #</b>	<b>Description</b>
86	3'-0" X 1'-9" Prestressed Concrete Cored Slabs



**SPECIALTY ITEMS:**

(7-1-95)(Rev. 1-16-24)

108-6

SP1 G37

Items listed below will be the specialty items for this contract (see Article 108-6 of the *Standard Specifications*).

Line #	Description
27-30	Guardrail
38,39	Signing
42	Long-Life Pavement Markings
43	Permanent Pavement Markers
44-69	Erosion Control

**FUEL PRICE ADJUSTMENT:**

(11-15-05)(Rev. 1-16-24)

109-8

SP1 G43

**Page 1-82, Article 109-8, FUEL PRICE ADJUSTMENTS**, add the following:

The base index price for DIESEL #2 FUEL is \$ **2.6456** per gallon. Where any of the following are included as pay items in the contract, they will be eligible for fuel price adjustment.

The pay items and the fuel factor used in calculating adjustments to be made will be as follows:

Description	Units	Fuel Usage Factor Diesel
Unclassified Excavation	Gal/CY	0.29
Borrow Excavation	Gal/CY	0.29
Class IV Subgrade Stabilization	Gal/Ton	0.55
Aggregate Base Course	Gal/Ton	0.55
Sub-Ballast	Gal/Ton	0.55
Erosion Control Stone	Gal/Ton	0.55
Rip Rap, Class _____	Gal/Ton	0.55
Asphalt Concrete Base Course, Type _____	Gal/Ton	0.90 or 2.90
Asphalt Concrete Intermediate Course, Type _____	Gal/Ton	0.90 or 2.90
Asphalt Concrete Surface Course, Type _____	Gal/Ton	0.90 or 2.90
Open-Graded Asphalt Friction Course	Gal/Ton	0.90 or 2.90
Permeable Asphalt Drainage Course, Type _____	Gal/Ton	0.90 or 2.90
Sand Asphalt Surface Course, Type _____	Gal/Ton	0.90 or 2.90
Ultra-thin Bonded Wearing Course	Gal/Ton	0.90 or 2.90
Aggregate for Cement Treated Base Course	Gal/Ton	0.55
Portland Cement for Cement Treated Base Course	Gal/Ton	0.55
> 11" Portland Cement Concrete Pavement	Gal/SY	0.327
Concrete Shoulders Adjacent to > 11" Pavement	Gal/SY	0.327
9" to 11" Portland Cement Concrete Pavement	Gal/SY	0.272
Concrete Shoulders Adjacent to 9" to 11" Pavement	Gal/SY	0.272
< 9" Portland Cement Concrete Pavement	Gal/SY	0.245
Concrete Shoulders Adjacent to < 9" Pavement	Gal/SY	0.245

For the asphalt items noted in the chart as eligible for fuel adjustments, the bidder may include the *Fuel Usage Factor Adjustment Form* with their bid submission if they elect to use the fuel usage factor. The *Fuel Usage Factor Adjustment Form* is found at the following link:

<https://connect.ncdot.gov/letting/LetCentral/Fuel%20Usage%20Factor%20Adjustment%20Form%20-%20Starting%20Nov%202022%20Lettings.pdf>

Select either 2.90 Gal/Ton fuel factor or 0.90 Gal/Ton fuel factor for each asphalt line item on the *Fuel Usage Factor Adjustment Form*. The selected fuel factor for each asphalt item will remain in effect for the duration of the contract.

Failure to complete the *Fuel Usage Factor Adjustment Form* will result in using 2.90 gallons per ton as the Fuel Usage Factor for Diesel for the asphalt items noted above. The contractor will not be permitted to change the Fuel Usage Factor after the bids are submitted.

### **STEEL PRICE ADJUSTMENT:**

(4-19-22)(Rev. 12-20-22)

SP1 G47

#### **Description and Purpose**

Steel price adjustments will be made to the payments due the Contractor for items as defined herein that are permanently incorporated into the work, when the price of raw steel mill products utilized on the contract have fluctuated. The Department will adjust monthly progress payments up or down as appropriate for cost changes in steel according to this provision.

#### **Eligible Items**

The list of eligible bid items for steel price adjustment can be found on the Departments website at the following address:

<https://connect.ncdot.gov/letting/LetCentral/Eligible%20Bid%20Items%20for%20Steel%20Price%20Adjustment.xlsx>

Nuts, bolts, anchor bolts, rebar chairs, connecting bands and other miscellaneous hardware associated with these items shall not be included in the price adjustment.

Adjustments will only be made for fluctuations in the material cost of the steel used in the above products as specified in the Product Relationship Table below. The producing mill is defined as the source of steel product before any fabrication has occurred (e.g., coil, plate, rebar, hot rolled shapes, etc.). No adjustment will be made for changes in the cost of fabrication, coating, shipping, storage, etc.

No steel price adjustments will be made for any products manufactured from steel having an adjustment date, as defined by the Product Relationship Table below, prior to the letting date.

### **Bid Submittal Requirements**

The successful bidder, within 14 calendar days after the notice of award is received by him, shall provide the completed Form SPA-1 to the Department (State Contract Officer or Division Contract Engineer) along with the payment bonds, performance bonds and contract execution signature sheets in a single submittal. If Form SPA-1 is not included in the same submittal as the payment bonds, performance bonds and contract execution signature sheets, the Contractor will not be eligible for any steel price adjustment for any item in the contract for the life of the contract. Form SPA-1 can be found on the Department's website at the following address:

<https://connect.ncdot.gov/letting/LetCentral/Form%20SPA-1.xlsm>

The Contractor shall provide Form SPA-1 listing the Contract Line Number, (with corresponding Item Number, Item Description, and Category) for the steel products they wish to have an adjustment calculated. Only the contract items corresponding to the list of eligible item numbers for steel price adjustment may be entered on Form SPA-1. The Contractor may choose to have steel price adjustment applied to any, all, or none of the eligible items. However, the Contractor's selection of items for steel price adjustment or non-selection (non-participation) may not be changed once Form SPA-1 has been received by the Department. Items the Bidder chooses for steel price adjustment must be designated by writing the word "Yes" in the column titled "Option" by each Pay Item chosen for adjustment. Should the bidder elect an eligible steel price item, the entire quantity of the line item will be subject to the price adjustment for the duration of the Contract. The Bidder's designations on Form SPA-1 must be written in ink or typed and signed by the Bidder (Prime Contractor) to be considered complete. Items not properly designated, designated with "No", or left blank on the Bidder's Form SPA-1 will automatically be removed from consideration for adjustment. No steel items will be eligible for steel price adjustment on this Project if the Bidder fails to return Form SPA-1 in accordance with this provision.

### **Establishing the Base Price**

The Department will use a blend of monthly average prices as reported from the Fastmarkets platform to calculate the monthly adjustment indices (BI and MI). This data is typically available on the first day of the month for the preceding month. The indices will be calculated by the Department for the different categories found on the Product Relationship Table below. For item numbers that include multiple types of steel products, the category listed for that item number will be used for adjusting each steel component.

The bidding index for Category 1 Steel items is **\$ 41.25** per hundredweight.  
The bidding index for Category 2 Steel items is **\$ 56.37** per hundredweight.  
The bidding index for Category 3 Steel items is **\$ 61.05** per hundredweight.  
The bidding index for Category 4 Steel items is **\$ 44.26** per hundredweight.  
The bidding index for Category 5 Steel items is **\$ 53.94** per hundredweight.  
The bidding index for Category 6 Steel items is **\$ 60.03** per hundredweight.  
The bidding index for Category 7 Steel items is **\$ 42.53** per hundredweight.

The bidding index represents a selling price of steel based on Fastmarkets data for the month of **April 2024**.

- MI = Monthly Index. – in Dollars (\$) per hundredweight (CWT). Use the adjustment indices from the month the steel was shipped from the producing mill, received on the project, or member cast as defined in the Product Relationship Table.
- BI = Bidding Index. - in Dollars (\$) per hundredweight (CWT). Use the adjustment indices as listed in the proposal.

<i>Product Relationship Table</i>			
<i>Steel Product (Title)</i>	BI, MI*	Adjustment Date for MI	Category
Reinforcing Steel, Bridge Deck, and SIP Forms	Based on one or more Fastmarkets indices	Delivery Date from Producing Mill	1
Structural Steel and Encasement Pipe	Based on one or more Fastmarkets indices	Delivery Date from Producing Mill	2
Steel H-Piles, Soldier Pile Walls	Based on one or more Fastmarkets indices	Delivery Date from Producing Mill	3
Guardrail Items and Pipe Piles	Based on one or more Fastmarkets indices	Material Received Date**	4
Fence Items	Based on one or more Fastmarkets indices	Material Received Date**	5
Overhead Sign Assembly, Signal Poles, High Mount Standards	Based on one or more Fastmarkets indices	Material Received Date**	6
Prestressed Concrete Members	Based on one or more Fastmarkets indices	Cast Date of Member	7
* BI and MI are in converted units of Dollars per Hundredweight (\$/CWT)			
** Material Received Date is defined as the date the materials are received on the project site. If a material prepayment is made for a Category 4-6 item, the Adjustment Date to be used will be the date of the prepayment request instead of the Materials Received Date.			

Submit documentation to the Engineer for all items listed in the Contract for which the Contractor is requesting a steel price adjustment.

**Submittal Requirements**

The items in categories 1,2, and 3, shall be specifically stored, labeled, or tagged, recognizable by color marking, and identifiable by Project for inspection and audit verification immediately upon arrival at the fabricator.

Furnish the following documentation for all steel products to be incorporated into the work and documented on Form SPA-2, found on the Departments website at the following address:

<https://connect.ncdot.gov/projects/construction/Construction%20Forms/Form%20SPA-2.xlsx>

Submit all documentation to the Engineer prior to incorporation of the steel into the completed work. The Department will withhold progress payments for the affected contract line item if the documentation is not provided and at the discretion of the Engineer the work is allowed to proceed. Progress payments will be made upon receipt of the delinquent documentation.

## Step 1 (Form SPA -2)

Utilizing Form SPA-2, submit separate documentation packages for each line item from Form SPA-1 for which the Contractor opted for a steel price adjustment. For line items with multiple components of steel, each component should be listed separately. Label each SPA-2 documentation package with a unique number as described below.

- a. Documentation package number: (Insert the contract line-item) - (Insert sequential package number beginning with "1").  
Example: 412 - 1,  
412 - 2,  
424 - 1,  
424 - 2,  
424 - 3, etc.
- b. The steel product quantity in pounds
  - i. The following sources should be used, in declining order of precedence, to determine the weight of steel/iron, based on the Engineers decision:
    1. Department established weights of steel/iron by contract pay item per pay unit;
    2. Approved Shop Drawings;
    3. Verified Shipping Documents;
    4. Contract Plans;
    5. Standard Drawing Sheets;
    6. Industry Standards (i.e., AISC Manual of Steel Construction, AWWA Standards, etc.); and
    7. Manufacture's data.
  - ii. Any item requiring approved shop drawings shall have the weights of steel calculated and shown on the shop drawings or submitted and certified separately by the fabricator.
- c. The date the steel product, subject to adjustment, was shipped from the producing mill (Categories 1-3), received on the project (Categories 4-6), or casting date (Category 7).

## Step 2 (Monthly Calculator Spreadsheet)

For each month, upon the incorporation of the steel product into the work, provide the Engineer the following:

- 1) Completed NCDOT Steel Price Adjustment Calculator Spreadsheet, summarizing all the steel submittal packages (Form SPA-2) actually incorporated into the completed work in the given month.
  - a. Contract Number
  - b. Bidding Index Reference Month
  - c. Contract Completion Date or Revised Completion Date
  - d. County, Route, and Project TIP information

- e. Item Number
  - f. Line-Item Description
  - g. Submittal Number from Form SPA-2
  - h. Adjustment date
  - i. Pounds of Steel
- 2) An affidavit signed by the Contractor stating the documentation provided in the NCDOT Steel Price Adjustment Calculator Spreadsheet is true and accurate.

### Price Adjustment Conditions

Download the Monthly Steel Adjustment Spreadsheet with the most current reference data from the Department's website each month at the following address:

<https://connect.ncdot.gov/projects/construction/Construction%20Forms/Form%20SPA-3%20NCDOT%20Steel%20Price%20Adjustment%20Calculator.xlsx>

If the monthly Fastmarkets data is not available, the data for the most recent immediately preceding month will be used as the basis for adjustment.

### Price Adjustment Calculations

The price adjustment will be determined by comparing the percentage of change in index value listed in the proposal (BI) to the monthly index value (MI). (See included sample examples). Weights and date of shipment must be documented as required herein. The final price adjustment dollar value will be determined by multiplying this percentage increase or decrease in the index by the represented quantity of steel incorporated into the work, and the established bidding index (BI) subject to the limitations herein.

#### Price increase/decrease will be computed as follows:

$$\text{SPA} = ((\text{MI} / \text{BI}) - 1) * \text{BI} * (\text{Q} / 100)$$

Where;

SPA = Steel price adjustment in dollars

MI = Monthly Shipping Index. – in Dollars (\$) per hundredweight (CWT). Use the adjustment indices from the month the steel was shipped from the producing mill, received on the project, or member cast as defined in the Product Relationship Table.

BI = Bidding Index. - in Dollars (\$) per hundredweight (CWT). Use the adjustment indices as listed in the proposal.

Q = Quantity of steel, product, pounds actually incorporated into the work as documented by the Contractor, or Design Build Team and verified by the Engineer.

Calculations for price adjustment shall be shown separate from the monthly progress estimate and will not be included in the total cost of work for determination of progress or for extension of Contract time in accordance with Subarticle 108-10(B)(1).

Any apparent attempt to unbalance bids in favor of items subject to price adjustment may result in rejection of the bid proposal.

Adjustments will be paid or charged to the Contractor only. Any Contractor receiving an adjustment under this provision shall distribute the proper proportional part of such adjustments to the subcontractor who performed the applicable work.

Delays to the work caused by steel shortages may be justification for a Contract time extension but will not constitute grounds for claims for standby equipment, extended office overhead, or other costs associated with such delays.

If an increase in the steel material price is anticipated to exceed 50% of the original quoted price, the contractor must notify the Department within 7 days prior to purchasing the material. Upon receipt of such notification, the Department will direct the Contractor to either (1) proceed with the work or (2) suspend the work and explore the use of alternate options.

If the decrease in the steel material exceeds 50% of the original quoted price, the contractor may submit to the Department additional market index information specific to the item in question to dispute the decrease. The Department will review this information and determine if the decrease is warranted.

When the steel product adjustment date, as defined in the Product Relationship Table, is after the approved contract completion date, the steel price adjustments will be based on the lesser value of either the MI for the month of the approved contract completion date or the MI for the actual adjustment date.

If the price adjustment is based on estimated material quantities for that time, and a revision to the total material quantity is made in a subsequent or final estimate, an appropriate adjustment will be made to the price adjustment previously calculated. The adjustment will be based on the same indices used to calculate the price adjustment which is being revised. If the adjustment date of the revised material quantity cannot be determined, the adjustment for the quantity in question, will be based on the indices utilized to calculate the steel price adjustment for the last initial documentation package submission, for the steel product subject to adjustment, that was incorporated into the particular item of work, for which quantities are being finalized.

Example: Structural steel for a particular bridge was provided for in three different shipments with each having a different mill shipping date. The quantity of structural steel actually used for the bridge was calculated and a steel price adjustment was made in a progress payment. At the conclusion of the work an error was found in the plans of the final quantity of structural steel used for the bridge. The quantity to be adjusted cannot be directly related to any one of the three mill shipping dates. The steel price adjustment for the quantity in question would be calculated using the indices that were utilized to calculate the steel price adjustment for the quantity of structural steel represented by the last initial structural steel documentation package submission. The package used will be the one with the greatest sequential number.

**Extra Work/Force Account:**

When steel products, as specified herein, are added to the contract as extra work, in accordance with the provisions of Article 104-7 or 104-3, the Engineer will determine and specify in the supplemental agreement, the need for application of steel price adjustments on a case-by-case basis. No steel price adjustments will be made for any products manufactured from steel having an adjustment date prior to the supplemental agreement execution date. Price adjustments will be made as provided herein, except the Bidding Index will be based on the month in which the supplemental agreement pricing was executed.

For work performed on force account basis, reimbursement of actual material costs, along with the specified overhead and profit markup, will be considered to include full compensation for the current cost of steel and no steel price adjustments will be made.



**Examples Form SPA-2**

**Steel Price Adjustment Submission Form**

Contract Number     C203394     Bid Reference Month     January 2019    

Submittal Date     8/31/2019    

Contract Line Item     237    

Line Item Description     APPROX....LBS Structural Steel    

Sequential Submittal Number     2    

Supplier	Description of material	Location information	Quantity in lbs.	Adjustment Date
XYZ mill	Structural Steel	Structure 3, Spans A-C	1,200,000	May 4, 2020
ABC distributing	Various channel & angle shapes	Structure 3 Spans A-C	35,000	July 14, 2020
		Total Pounds of Steel	1,235,000	

- Note: Attach the following supporting documentation to this form.
- Bill of Lading to support the shipping dates
  - Supporting information for weight documentation (e.g., Pay item reference, Shop drawings, shipping documents, Standards Sheets, industry standards, or manufacturer's data)

By providing this data under my signature, I attest to the accuracy of and validity of the data on this form and certify that no deliberate misrepresentation in any manner has occurred.

Printed Name  
\_\_\_\_\_

Signature  
\_\_\_\_\_

**Examples Form SPA-2**  
**Steel Price Adjustment Submission Form**

Contract Number C203394 Bid Reference Month January 2019

Submittal Date August 31, 2019

Contract Line Item 237

Line Item Description SUPPORT, OVRHD SIGN STR -DFEB – STA 36+00

Sequential Submittal Number 2

Supplier	Description of material	Location information	Quantity in lbs.	Adjustment Date
XYZ mill	Tubular Steel (Vertical legs)	<u>-DFEB – STA 36+00</u>	12000	December 11, 2021
PDQ Mill	4” Tubular steel (Horizontal legs)	<u>-DFEB – STA 36+00</u>	5900	December 11, 2021
ABC distributing	Various channel & angle shapes (see quote)	<u>-DFEB – STA 36+00</u>	1300	December 11, 2021
	Catwalk assembly	<u>-DFEB – STA 36+00</u>	2000	December 11, 2021
Nucor	Flat plate	<u>-DFEB – STA 36+00</u>	650	December 11, 2021
		Total Pounds of Steel	21,850	

Note: Attach the following supporting documentation to this form.

- Bill of Lading to support the shipping dates
- Supporting information for weight documentation (e.g., Pay item reference, Shop drawings, shipping documents, Standards Sheets, industry standards, or manufacturer's data)

By providing this data under my signature, I attest to the accuracy of and validity of the data on this form and certify that no deliberate misrepresentation in any manner has occurred.

Printed Name  
 \_\_\_\_\_

Signature  
 \_\_\_\_\_

**Price Adjustment Sample Calculation (increase)**

---

Project bid on September 17, 2019

Line Item 635 "Structural Steel" has a plan quantity of 2,717,000 lbs.

Bidding Index for Structural Steel (Category 2) in the proposal was \$36.12/CWT = BI

450,000 lbs. of Structural Steel for Structure 2 at Station 44+08.60 were shipped to fabricator from the producing mill in same month, May 2021.

Monthly Index for Structural Steel (Category 2) for May 2021 was \$64.89/CWT = MI

The Steel Price Adjustment formula is as follows:

$$\text{SPA} = ((\text{MI} / \text{BI}) - 1) * \text{BI} * (\text{Q} / 100)$$

Where; SPA = Steel price adjustment in dollars

BI = Bidding Index – in dollars (\$) per hundredweight (CWT). Use the adjustment indices as listed in the proposal.

MI = Mill Shipping Index – in dollars (\$) per hundredweight (CWT). Use the adjustment indices from the month the steel was shipped from the producing mill, received on the project, or member cast as defined in the Product Relationship Table.

Q = Quantity of steel product, in pounds (lbs.) actually incorporated into the work as documented by the Contractor, or Design Build Team and verified by the Engineer.

$$\text{BI} = \$36.12 / \text{CWT}$$

$$\text{MI} = \$64.89 / \text{CWT}$$

$$\% \text{ change} = ((\text{MI} / \text{BI}) - 1) = (\$64.89 / \$36.12 - 1) = (1.79651 - 1) = 0.79651162791$$

$$\text{Q} = 450,000 \text{ lbs.}$$

$$\text{SPA} = 0.79651162791 \times \$36.12 \times (450,000 / 100)$$

$$\text{SPA} = 0.79651162791 * \$36.12 * 4,500$$

$$\text{SPA} = \$129,465 \text{ pay adjustment to Contractor for Structural Steel (Structure 2 at Station 44+08.60)}$$

**Price Adjustment Sample Calculation (decrease)**

---

Project bid on December 18, 2018

Line Item 635 Structural Steel has a plan quantity of 2,717,000 lbs.

Bidding Index for Structural Steel (Category 2) in the proposal was \$46.72/CWT = BI

600,000 lbs. of Structural Steel for Structure 1 at Station 22+57.68 were shipped to fabricator from the producing mill in same month, August 2020.

Monthly Index for Structural Steel (Category 2) for August 2020 was \$27.03/CWT = MI

The Steel Price Adjustment formula is as follows:

$$\text{SPA} = ((\text{MI} / \text{BI}) - 1) * \text{BI} * (\text{Q} / 100)$$

Where; SPA = Steel price adjustment in dollars

BI = Bidding Index – in dollars (\$) per hundredweight (CWT). Use the adjustment indices as listed in the proposal.

MI = Mill Shipping Index – in dollars (\$) per hundredweight (CWT). Use the adjustment indices from the month the steel was shipped from the producing mill, received on the project, or member cast as defined in the Product Relationship Table.

Q = Quantity of steel product, in pounds (lbs.) actually incorporated into the work as documented by the Contractor, or Design Build Team and verified by the Engineer.

$$\text{BI} = \$46.72 / \text{CWT}$$

$$\text{MI} = \$27.03 / \text{CWT}$$

$$\% \text{ change} = ((\text{MI} / \text{BI}) - 1) = (\$27.03 / \$46.72 - 1) = (0.57855 - 1) = -0.421446917808$$

$$\text{Q} = 600,000 \text{ lbs.}$$

$$\text{SPA} = -0.421446917808 * \$46.72 * (600,000 / 100)$$

$$\text{SPA} = -0.421446917808 * \$46.72 * 6,000$$

$$\text{SPA} = \$ 118,140.00 \text{ Credit to the Department for Structural Steel (Structure 1 at Station 22+57.68)}$$

**Price Adjustment Sample Calculation (increase)**

---

Project bid on July 16, 2020

Line Item 614 Reinforced Concrete Deck Slab has a plan quantity of 241974 lbs.

Bidding Index Reference Month was May 2020. Bidding Index for Reinforced Concrete Deck Slab (Category 1) in the proposal was \$29.21/CWT = BI

51,621 lbs. of reinforcing steel and 52,311 lbs. of epoxy coated reinforcing steel for Structure 2 at Station 107+45.55 -L- was shipped to fabricator from the producing mill in same month, May 2021.

Monthly Index for Reinforced Concrete Deck Slab (Category 1) for May 2021 was \$43.13/CWT = MI

The Steel Price Adjustment formula is as follows:

$$\text{SPA} = ((\text{MI} / \text{BI}) - 1) * \text{BI} * (\text{Q} / 100)$$

Where; SPA = Steel price adjustment in dollars

BI = Bidding Index – in dollars (\$) per hundredweight (CWT). Use the adjustment indices as listed in the proposal.

MI = Mill Shipping Index – in dollars (\$) per hundredweight (CWT). Use the adjustment indices from the month the steel was shipped from the producing mill, received on the project, or member cast as defined in the Product Relationship Table.

Q = Quantity of steel product, in pounds (lbs.) actually incorporated into the work as documented by the Contractor, or Design Build Team and verified by the Engineer.

$$\text{BI} = \$29.21 / \text{CWT}$$

$$\text{MI} = \$43.13 / \text{CWT}$$

$$\% \text{ change} = ((\text{MI} / \text{BI}) - 1) = (\$43.13 / \$29.21 - 1) = (1.47655 - 1) = 0.47654912701$$

$$\text{Q} = 103932 \text{ lbs.}$$

$$\text{SPA} = 0.47654912701 * \$29.21 * (103,932 / 100)$$

$$\text{SPA} = 0.47654912701 * \$29.21 * 1,039.32$$

SPA = \$14,467.33 Pay Adjustment to Contractor for Reinforced Concrete Deck Slab (Category 1) at Station 107+45.55 -L-

**SCHEDULE OF ESTIMATED COMPLETION PROGRESS:**

(7-15-08)(Rev. 1-16-24)

108-2

SP1 G58

The Contractor's attention is directed to the Standard Special Provision entitled *Availability of Funds Termination of Contracts* included elsewhere in this proposal. The Department of Transportation's schedule of estimated completion progress for this project as required by that Standard Special Provision is as follows:

	<b><u>Fiscal Year</u></b>	<b><u>Progress (% of Dollar Value)</u></b>
2025	(7/01/24 - 6/30/25)	100% of Total Amount Bid

The Contractor shall also furnish his own progress schedule in accordance with Article 108-2 of the *Standard Specifications*. Any acceleration of the progress as shown by the Contractor's progress schedule over the progress as shown above shall be subject to the approval of the Engineer.

**DISADVANTAGED BUSINESS ENTERPRISE (DIVISIONS):**

(10-16-07)(Rev. 1-16-24)

102-15(J)

SP1 G62

**Description**

The purpose of this Special Provision is to carry out the U.S. Department of Transportation's policy of ensuring nondiscrimination in the award and administration of contracts financed in whole or in part with Federal funds. This provision is guided by 49 CFR Part 26.

**Definitions**

*Additional DBE Subcontractors* - Any DBE submitted at the time of bid that will not be used to meet the DBE goal. No submittal of a Letter of Intent is required.

*Committed DBE Subcontractor* - Any DBE submitted at the time of bid that is being used to meet the DBE goal by submission of a Letter of Intent. Or any DBE used as a replacement for a previously committed DBE firm.

*Contract Goal Requirement* - The approved DBE participation at time of award, but not greater than the advertised contract goal.

*DBE Goal* - A portion of the total contract, expressed as a percentage, that is to be performed by committed DBE subcontractor(s).

*Disadvantaged Business Enterprise (DBE)* - A firm certified as a Disadvantaged Business Enterprise through the North Carolina Unified Certification Program.

*Goal Confirmation Letter* - Written documentation from the Department to the bidder confirming the Contractor's approved, committed DBE participation along with a listing of the committed DBE firms.

*Manufacturer* - A firm that operates or maintains a factory or establishment that produces on the premises, the materials or supplies obtained by the Contractor.

*Regular Dealer* - A firm that owns, operates, or maintains a store, warehouse, or other establishment in which the materials or supplies required for the performance of the contract are bought, kept in stock, and regularly sold to the public in the usual course of business. A regular dealer engages in, as its principal business and in its own name, the purchase and sale or lease of the products in question. A regular dealer in such bulk items as steel, cement, gravel, stone, and petroleum products need not keep such products in stock, if it owns and operates distribution equipment for the products. Brokers and packagers are not regarded as manufacturers or regular dealers within the meaning of this section.

*Replacement / Substitution* – A full or partial reduction in the amount of work subcontracted to a committed (or an approved substitute) DBE firm.

*North Carolina Unified Certification Program (NCUCP)* - A program that provides comprehensive services and information to applicants for DBE certification, such that an applicant is required to apply only once for a DBE certification that will be honored by all recipients of USDOT funds in the state and not limited to the Department of Transportation only. The Certification Program is in accordance with 49 CFR Part 26.

*United States Department of Transportation (USDOT)* - Federal agency responsible for issuing regulations (49 CFR Part 26) and official guidance for the DBE program.

#### **Forms and Websites Referenced in this Provision**

*DBE Payment Tracking System* - On-line system in which the Contractor enters the payments made to DBE subcontractors who have performed work on the project.  
<https://apps.dot.state.nc.us/Vendor/PaymentTracking/>

*DBE-IS Subcontractor Payment Information* - Form for reporting the payments made to all DBE firms working on the project. This form is for paper bid projects only.  
<https://connect.ncdot.gov/business/Turnpike/Documents/Form%20DBE-IS%20Subcontractor%20Payment%20Information.pdf>

*RF-1 DBE Replacement Request Form* - Form for replacing a committed DBE.  
<https://connect.ncdot.gov/projects/construction/Construction%20Forms/DBE%20MBE%20WBE%20Replacement%20Form%20and%20Instructions.pdf>

*SAF Subcontract Approval Form* - Form required for approval to sublet the contract.  
<https://connect.ncdot.gov/projects/construction/Construction%20Forms/SAF%20Form%20-%20Subcontract%20Approval%20Form%20Revised%2004-19.xlsm>

*JC-1 Joint Check Notification Form* - Form and procedures for joint check notification. The form acts as a written joint check agreement among the parties providing full and prompt disclosure of the expected use of joint checks.  
<https://connect.ncdot.gov/projects/construction/Construction%20Forms/Joint%20Check%20Notification%20Form.pdf>

*Letter of Intent* - Form signed by the Contractor and the DBE subcontractor, manufacturer or regular dealer that affirms that a portion of said contract is going to be performed by the signed DBE for the estimated amount (based on quantities and unit prices) listed at the time of bid.

<http://connect.ncdot.gov/letting/LetCentral/Letter%20of%20Intent%20to%20Perform%20as%20a%20Subcontractor.pdf>

*Listing of DBE Subcontractors Form* - Form for entering DBE subcontractors on a project that will meet this DBE goal. This form is for paper bids only.

[http://connect.ncdot.gov/municipalities/Bid%20Proposals%20for%20LGA%20Content/08%20DBE%20Subcontractors%20\(Federal\).docx](http://connect.ncdot.gov/municipalities/Bid%20Proposals%20for%20LGA%20Content/08%20DBE%20Subcontractors%20(Federal).docx)

*Subcontractor Quote Comparison Sheet* - Spreadsheet for showing all subcontractor quotes in the work areas where DBEs quoted on the project. This sheet is submitted with good faith effort packages.

<http://connect.ncdot.gov/business/SmallBusiness/Documents/DBE%20Subcontractor%20Quote%20Comparison%20Example.xls>

### **DBE Goal**

The following DBE goal for participation by Disadvantaged Business Enterprises is established for this contract:

Disadvantaged Business Enterprises 4 %

- (A) *If the DBE goal is more than zero*, the Contractor shall exercise all necessary and reasonable steps to ensure that DBEs participate in at least the percent of the contract as set forth above as the DBE goal.
- (B) *If the DBE goal is zero*, the Contractor shall make an effort to recruit and use DBEs during the performance of the contract. Any DBE participation obtained shall be reported to the Department.

### **Directory of Transportation Firms (Directory)**

Real-time information is available about firms doing business with the Department and firms that are certified through NCUCP in the Directory of Transportation Firms. Only firms identified in the Directory as DBE certified shall be used to meet the DBE goal. The Directory can be found at the following link. [https:// www.ebs.nc.gov/VendorDirectory/default.html](https://www.ebs.nc.gov/VendorDirectory/default.html)

The listing of an individual firm in the directory shall not be construed as an endorsement of the firm's capability to perform certain work.



### Listing of DBE Subcontractors

At the time of bid, bidders shall submit all DBE participation that they anticipate to use during the life of the contract. Only those identified to meet the DBE goal will be considered committed, even though the listing shall include both committed DBE subcontractors and additional DBE subcontractors. Additional DBE subcontractor participation submitted at the time of bid will be used toward the Department's overall race-neutral goal. Only those firms with current DBE certification at the time of bid opening will be acceptable for listing in the bidder's submittal of DBE participation. The Contractor shall indicate the following required information:

(A) Electronic Bids

Bidders shall submit a listing of DBE participation in the appropriate section of the electronic submittal file.

- (1) Submit the names and addresses of DBE firms identified to participate in the contract. If the bidder uses the updated listing of DBE firms shown in the electronic submittal file, the bidder may use the dropdown menu to access the name and address of the DBE firm.
- (2) Submit the contract line numbers of work to be performed by each DBE firm. When no figures or firms are entered, the bidder will be considered to have no DBE participation.
- (3) The bidder shall be responsible for ensuring that the DBE is certified at the time of bid by checking the Directory of Transportation Firms. If the firm is not certified at the time of the bid-letting, that DBE's participation will not count towards achieving the DBE goal.

(B) Paper Bids

- (1) *If the DBE goal is more than zero,*
  - (a) Bidders, at the time the bid proposal is submitted, shall submit a listing of DBE participation, including the names and addresses on *Listing of DBE Subcontractors* contained elsewhere in the contract documents in order for the bid to be considered responsive. Bidders shall indicate the total dollar value of the DBE participation for the contract.
  - (b) If bidders have no DBE participation, they shall indicate this on the *Listing of DBE Subcontractors* by entering the word "None" or the number "0." This form shall be completed in its entirety. **Blank forms will not be deemed to represent zero participation.** Bids submitted that do not have DBE participation indicated on the appropriate form will not be read publicly during the opening of bids. The Department will not consider these bids for award and the proposal will be rejected.

- (c) The bidder shall be responsible for ensuring that the DBE is certified at the time of bid by checking the Directory of Transportation Firms. If the firm is not certified at the time of the bid-letting, that DBE's participation will not count towards achieving the DBE goal.
- (2) *If the DBE goal is zero, entries on the Listing of DBE Subcontractors are not required, however any DBE participation that is achieved during the project shall be reported in accordance with requirements contained elsewhere in the special provision.*

### **DBE Prime Contractor**

When a certified DBE firm bids on a contract that contains a DBE goal, the DBE firm is responsible for meeting the goal or making good faith efforts to meet the goal, just like any other bidder. In most cases, a DBE bidder on a contract will meet the DBE goal by virtue of the work it performs on the contract with its own forces. However, all the work that is performed by the DBE bidder and any other DBE subcontractors will count toward the DBE goal. The DBE bidder shall list itself along with any DBE subcontractors, if any, in order to receive credit toward the DBE goal.

For example, if the DBE goal is 45% and the DBE bidder will only perform 40% of the contract work, the prime will list itself at 40%, and the additional 5% shall be obtained through additional DBE participation with DBE subcontractors or documented through a good faith effort.

DBE prime contractors shall also follow Sections A or B listed under *Listing of DBE Subcontractor* just as a non-DBE bidder would.

### **Written Documentation – Letter of Intent**

The bidder shall submit written documentation for each DBE that will be used to meet the DBE goal of the contract, indicating the bidder's commitment to use the DBE in the contract. This documentation shall be submitted on the Department's form titled *Letter of Intent*.

The documentation shall be received in the office of the Engineer no later than 2:00 p.m. of the fifth calendar day following opening of bids, unless the fifth day falls on Saturday, Sunday or an official state holiday. In that situation, it is due in the office of the Engineer no later than 10:00 a.m. on the next official state business day.

If the bidder fails to submit the Letter of Intent from each committed DBE to be used toward the DBE goal, or if the form is incomplete (i.e. both signatures are not present), the DBE participation will not count toward meeting the DBE goal. If the lack of this participation drops the commitment below the DBE goal, the Contractor shall submit evidence of good faith efforts, completed in its entirety, to the Engineer no later than 2:00 p.m. on the eighth calendar day following opening of bids, unless the eighth day falls on Saturday, Sunday or an official state holiday. In that situation, it is due in the office of the Engineer no later than 10:00 a.m. on the next official state business day.

**Submission of Good Faith Effort**

If the bidder fails to meet or exceed the DBE goal the apparent lowest responsive bidder shall submit to the Department documentation of adequate good faith efforts made to reach the DBE goal.

One complete set and 5 copies of this information shall be received in the office of the Engineer no later than 2:00 p.m. of the fifth calendar day following opening of bids, unless the fifth day falls on Saturday, Sunday or an official state holiday. In that situation, it is due in the office of the Engineer no later than 10:00 a.m. on the next official state business day.

Note: Where the information submitted includes repetitious solicitation letters, it will be acceptable to submit a representative letter along with a distribution list of the firms that were solicited. Documentation of DBE quotations shall be a part of the good faith effort submittal. This documentation may include written subcontractor quotations, telephone log notations of verbal quotations, or other types of quotation documentation.

**Consideration of Good Faith Effort for Projects with DBE Goals More Than Zero**

Adequate good faith efforts mean that the bidder took all necessary and reasonable steps to achieve the goal which, by their scope, intensity, and appropriateness, could reasonably be expected to obtain sufficient DBE participation. Adequate good faith efforts also mean that the bidder actively and aggressively sought DBE participation. Mere *pro forma* efforts are not considered good faith efforts.

The Department will consider the quality, quantity, and intensity of the different kinds of efforts a bidder has made. Listed below are examples of the types of actions a bidder will take in making a good faith effort to meet the goal and are not intended to be exclusive or exhaustive, nor is it intended to be a mandatory checklist.

- (A) Soliciting through all reasonable and available means (e.g. attendance at pre-bid meetings, advertising, written notices, use of verifiable electronic means through the use of the NCDOT Directory of Transportation Firms) the interest of all certified DBEs who have the capability to perform the work of the contract. The bidder must solicit this interest within at least 10 days prior to bid opening to allow the DBEs to respond to the solicitation. Solicitation shall provide the opportunity to DBEs within the Division and surrounding Divisions where the project is located. The bidder must determine with certainty if the DBEs are interested by taking appropriate steps to follow up initial solicitations.
- (B) Selecting portions of the work to be performed by DBEs in order to increase the likelihood that the DBE goals will be achieved.
  - (1) Where appropriate, break out contract work items into economically feasible units to facilitate DBE participation, even when the prime contractor might otherwise prefer to perform these work items with its own forces.

- (2) Negotiate with subcontractors to assume part of the responsibility to meet the contract DBE goal when the work to be sublet includes potential for DBE participation (2<sup>nd</sup> and 3<sup>rd</sup> tier subcontractors).
- (C) Providing interested DBEs with adequate information about the plans, specifications, and requirements of the contract in a timely manner to assist them in responding to a solicitation.
- (D)
  - (1) Negotiating in good faith with interested DBEs. It is the bidder's responsibility to make a portion of the work available to DBE subcontractors and suppliers and to select those portions of the work or material needs consistent with the available DBE subcontractors and suppliers, so as to facilitate DBE participation. Evidence of such negotiation includes the names, addresses, and telephone numbers of DBEs that were considered; a description of the information provided regarding the plans and specifications for the work selected for subcontracting; and evidence as to why additional agreements could not be reached for DBEs to perform the work.
  - (2) A bidder using good business judgment would consider a number of factors in negotiating with subcontractors, including DBE subcontractors, and would take a firm's price and capabilities as well as contract goals into consideration. However, the fact that there may be some additional costs involved in finding and using DBEs is not in itself sufficient reason for a bidder's failure to meet the contract DBE goal, as long as such costs are reasonable. Also, the ability or desire of a prime contractor to perform the work of a contract with its own organization does not relieve the bidder of the responsibility to make good faith efforts. Bidding contractors are not, however, required to accept higher quotes from DBEs if the price difference is excessive or unreasonable.
- (E) Not rejecting DBEs as being unqualified without sound reasons based on a thorough investigation of their capabilities. The bidder's standing within its industry, membership in specific groups, organizations, or associates and political or social affiliations (for example, union vs. non-union employee status) are not legitimate causes for the rejection or non-solicitation of bids in the bidder's efforts to meet the project goal.
- (F) Making efforts to assist interested DBEs in obtaining bonding, lines of credit, or insurance as required by the recipient or bidder.
- (G) Making efforts to assist interested DBEs in obtaining necessary equipment, supplies, materials, or related assistance or services.
- (H) Effectively using the services of available minority/women community organizations; minority/women contractors' groups; Federal, State, and local minority/women business assistance offices; and other organizations as allowed on a case-by-case basis to provide assistance in the recruitment and placement of DBEs. Contact within 7 days from the bid opening the Business Opportunity and Work Force Development Unit at [BOWD@ncdot.gov](mailto:BOWD@ncdot.gov) to give notification of the bidder's inability to get DBE quotes.

- (I) Any other evidence that the bidder submits which shows that the bidder has made reasonable good faith efforts to meet the DBE goal.

In addition, the Department may take into account the following:

- (1) Whether the bidder's documentation reflects a clear and realistic plan for achieving the DBE goal.
- (2) The bidders' past performance in meeting the DBE goals.
- (3) The performance of other bidders in meeting the DBE goal. For example, when the apparent successful bidder fails to meet the DBE goal, but others meet it, you may reasonably raise the question of whether, with additional reasonable efforts the apparent successful bidder could have met the goal. If the apparent successful bidder fails to meet the DBE goal, but meets or exceeds the average DBE participation obtained by other bidders, the Department may view this, in conjunction with other factors, as evidence of the apparent successful bidder having made a good faith effort.

If the Department does not award the contract to the apparent lowest responsive bidder, the Department reserves the right to award the contract to the next lowest responsive bidder that can satisfy to the Department that the DBE goal can be met or that an adequate good faith effort has been made to meet the DBE goal.

### **Non-Good Faith Appeal**

The Engineer will notify the contractor verbally and in writing of non-good faith. A contractor may appeal a determination of non-good faith made by the Goal Compliance Committee. If a contractor wishes to appeal the determination made by the Committee, they shall provide written notification to the Engineer. The appeal shall be made within 2 business days of notification of the determination of non-good faith.

### **Counting DBE Participation Toward Meeting DBE Goal**

- (A) Participation

The total dollar value of the participation by a committed DBE will be counted toward the contract goal requirement. The total dollar value of participation by a committed DBE will be based upon the value of work actually performed by the DBE and the actual payments to DBE firms by the Contractor.

- (B) Joint Checks

Prior notification of joint check use shall be required when counting DBE participation for services or purchases that involves the use of a joint check. Notification shall be through submission of Form JC-1 (*Joint Check Notification Form*) and the use of joint checks shall be in accordance with the Department's Joint Check Procedures.

## (C) Subcontracts (Non-Trucking)

A DBE may enter into subcontracts. Work that a DBE subcontracts to another DBE firm may be counted toward the contract goal requirement. Work that a DBE subcontracts to a non-DBE firm does not count toward the contract goal requirement. If a DBE contractor or subcontractor subcontracts a significantly greater portion of the work of the contract than would be expected on the basis of standard industry practices, it shall be presumed that the DBE is not performing a commercially useful function. The DBE may present evidence to rebut this presumption to the Department. The Department's decision on the rebuttal of this presumption is subject to review by the Federal Highway Administration but is not administratively appealable to USDOT.

## (D) Joint Venture

When a DBE performs as a participant in a joint venture, the Contractor may count toward its contract goal requirement a portion of the total value of participation with the DBE in the joint venture, that portion of the total dollar value being a distinct clearly defined portion of work that the DBE performs with its forces.

## (E) Suppliers

A contractor may count toward its DBE requirement 60 percent of its expenditures for materials and supplies required to complete the contract and obtained from a DBE regular dealer and 100 percent of such expenditures from a DBE manufacturer.

## (F) Manufacturers and Regular Dealers

A contractor may count toward its DBE requirement the following expenditures to DBE firms that are not manufacturers or regular dealers:

- (1) The fees or commissions charged by a DBE firm for providing a *bona fide* service, such as professional, technical, consultant, or managerial services, or for providing bonds or insurance specifically required for the performance of a DOT-assisted contract, provided the fees or commissions are determined to be reasonable and not excessive as compared with fees and commissions customarily allowed for similar services.
- (2) With respect to materials or supplies purchased from a DBE, which is neither a manufacturer nor a regular dealer, count the entire amount of fees or commissions charged for assistance in the procurement of the materials and supplies, or fees or transportation charges for the delivery of materials or supplies required on a job site (but not the cost of the materials and supplies themselves), provided the fees are determined to be reasonable and not excessive as compared with fees customarily allowed for similar services.

**Commercially Useful Function****(A) DBE Utilization**

The Contractor may count toward its contract goal requirement only expenditures to DBEs that perform a commercially useful function in the work of a contract. A DBE performs a commercially useful function when it is responsible for execution of the work of the contract and is carrying out its responsibilities by actually performing, managing, and supervising the work involved. To perform a commercially useful function, the DBE shall also be responsible with respect to materials and supplies used on the contract, for negotiating price, determining quality and quantity, ordering the material and installing (where applicable) and paying for the material itself. To determine whether a DBE is performing a commercially useful function, the Department will evaluate the amount of work subcontracted, industry practices, whether the amount the firm is to be paid under the contract is commensurate with the work it is actually performing and the DBE credit claimed for its performance of the work, and any other relevant factors.

**(B) DBE Utilization in Trucking**

The following factors will be used to determine if a DBE trucking firm is performing a commercially useful function:

- (1) The DBE shall be responsible for the management and supervision of the entire trucking operation for which it is responsible on a particular contract, and there shall not be a contrived arrangement for the purpose of meeting DBE goals.
- (2) The DBE shall itself own and operate at least one fully licensed, insured, and operational truck used on the contract.
- (3) The DBE receives credit for the total value of the transportation services it provides on the contract using trucks it owns, insures, and operates using drivers it employs.
- (4) The DBE may subcontract the work to another DBE firm, including an owner-operator who is certified as a DBE. The DBE who subcontracts work to another DBE receives credit for the total value of the transportation services the subcontracted DBE provides on the contract.
- (5) The DBE may also subcontract the work to a non-DBE firm, including from an owner-operator. The DBE who subcontracts the work to a non-DBE is entitled to credit for the total value of transportation services provided by the non-DBE subcontractor not to exceed the value of transportation services provided by DBE-owned trucks on the contract. Additional participation by non-DBE subcontractors receives credit only for the fee or commission it receives as a result of the subcontract arrangement. The value of services performed under subcontract agreements between the DBE and the Contractor will not count towards the DBE contract requirement.

- (6) A DBE may lease truck(s) from an established equipment leasing business open to the general public. The lease must indicate that the DBE has exclusive use of and control over the truck. This requirement does not preclude the leased truck from working for others during the term of the lease with the consent of the DBE, so long as the lease gives the DBE absolute priority for use of the leased truck. This type of lease may count toward the DBE's credit as long as the driver is under the DBE's payroll.
- (7) Subcontracted/leased trucks shall display clearly on the dashboard the name of the DBE that they are subcontracted/leased to and their own company name if it is not identified on the truck itself. Magnetic door signs are not permitted.

### **DBE Replacement**

When a Contractor has relied on a commitment to a DBE subcontractor (or an approved substitute DBE subcontractor) to meet all or part of a contract goal requirement, the contractor shall not terminate the DBE subcontractor for convenience. This includes, but is not limited to, instances in which the Contractor seeks to perform the work of the terminated subcontractor with another DBE subcontractor, a non-DBE subcontractor, or with the Contractor's own forces or those of an affiliate.

The Contractor must give notice in writing both by certified mail and email to the DBE subcontractor, with a copy to the Engineer of its intent to request to terminate and/or substitute, and the reason for the request. The Contractor must give the DBE subcontractor five (5) business days to respond to the Contractor's Notice of Intent to Request Termination and/or Substitution. If the DBE subcontractor objects to the intended termination/substitution, the DBE, within five (5) business days must advise the Contractor and the Department of the reasons why the action should not be approved. The five-day notice period shall begin on the next business day after written notice is provided to the DBE subcontractor.

A committed DBE subcontractor may only be terminated after receiving the Department's written approval based upon a finding of good cause for the proposed termination and/or substitution. For purposes of this section, good cause shall include the following circumstances:

- (a) The listed DBE subcontractor fails or refuses to execute a written contract;
- (b) The listed DBE subcontractor fails or refuses to perform the work of its subcontract in a way consistent with normal industry standards. Provided, however, that good cause does not exist if the failure or refusal of the DBE subcontractor to perform its work on the subcontract results from the bad faith or discriminatory action of the prime contractor;
- (c) The listed DBE subcontractor fails or refuses to meet the prime contractor's reasonable, nondiscriminatory bond requirements;
- (d) The listed DBE subcontractor becomes bankrupt, insolvent, or exhibits credit unworthiness;
- (e) The listed DBE subcontractor is ineligible to work on public works projects because of suspension and debarment proceedings pursuant to 2 CFR Parts 180, 215 and 1,200 or applicable state law;
- (f) The listed DBE subcontractor is not a responsible contractor;



- (g) The listed DBE voluntarily withdraws from the project and provides written notice of withdrawal;
- (h) The listed DBE is ineligible to receive DBE credit for the type of work required;
- (i) A DBE owner dies or becomes disabled with the result that the listed DBE contractor is unable to complete its work on the contract;
- (j) Other documented good cause that compels the termination of the DBE subcontractor. Provided, that good cause does not exist if the prime contractor seeks to terminate a DBE it relied upon to obtain the contract so that the prime contractor can self-perform the work for which the DBE contractor was engaged or so that the prime contractor can substitute another DBE or non-DBE contractor after contract award.

The Contractor shall comply with the following for replacement of a committed DBE:

(A) Performance Related Replacement

When a committed DBE is terminated for good cause as stated above, an additional DBE that was submitted at the time of bid may be used to fulfill the DBE commitment. A good faith effort will only be required for removing a committed DBE if there were no additional DBEs submitted at the time of bid to cover the same amount of work as the DBE that was terminated.

If a replacement DBE is not found that can perform at least the same amount of work as the terminated DBE, the Contractor shall submit a good faith effort documenting the steps taken. Such documentation shall include, but not be limited to, the following:

- (1) Copies of written notification to DBEs that their interest is solicited in contracting the work defaulted by the previous DBE or in subcontracting other items of work in the contract.
- (2) Efforts to negotiate with DBEs for specific subbids including, at a minimum:
  - (a) The names, addresses, and telephone numbers of DBEs who were contacted.
  - (b) A description of the information provided to DBEs regarding the plans and specifications for portions of the work to be performed.
- (3) A list of reasons why DBE quotes were not accepted.
- (4) Efforts made to assist the DBEs contacted, if needed, in obtaining bonding or insurance required by the Contractor.

(B) Decertification Replacement

- (1) When a committed DBE is decertified by the Department after the SAF (*Subcontract Approval Form*) has been received by the Department, the Department will not require the Contractor to solicit replacement DBE participation equal to the remaining work to be performed by the decertified firm. The

participation equal to the remaining work performed by the decertified firm will count toward the contract goal requirement.

- (2) When a committed DBE is decertified prior to the Department receiving the SAF (*Subcontract Approval Form*) for the named DBE firm, the Contractor shall take all necessary and reasonable steps to replace the DBE subcontractor with another DBE subcontractor to perform at least the same amount of work to meet the DBE goal requirement. If a DBE firm is not found to do the same amount of work, a good faith effort must be submitted to NCDOT (see A herein for required documentation).
- (3) Exception: If the DBE's ineligibility is caused solely by its having exceeded the size standard during the performance of the contract, the Department will not require the Contractor to solicit replacement DBE participation equal to the remaining work to be performed by the decertified firm. The participation equal to the remaining work performed by the decertified firm will count toward the contract goal requirement and overall goal.

All requests for replacement of a committed DBE firm shall be submitted to the Engineer for approval on Form RF-1 (*DBE Replacement Request*). If the Contractor fails to follow this procedure, the Contractor may be disqualified from further bidding for a period of up to 6 months

### **Changes in the Work**

When the Engineer makes changes that result in the reduction or elimination of work to be performed by a committed DBE, the Contractor will not be required to seek additional participation. When the Engineer makes changes that result in additional work to be performed by a DBE based upon the Contractor's commitment, the DBE shall participate in additional work to the same extent as the DBE participated in the original contract work.

When the Engineer makes changes that result in extra work, which has more than a minimal impact on the contract amount, the Contractor shall seek additional participation by DBEs unless otherwise approved by the Engineer.

When the Engineer makes changes that result in an alteration of plans or details of construction, and a portion or all of the work had been expected to be performed by a committed DBE, the Contractor shall seek participation by DBEs unless otherwise approved by the Engineer.

When the Contractor requests changes in the work that result in the reduction or elimination of work that the Contractor committed to be performed by a DBE, the Contractor shall seek additional participation by DBEs equal to the reduced DBE participation caused by the changes.

### **Reports and Documentation**

A SAF (*Subcontract Approval Form*) shall be submitted for all work which is to be performed by a DBE subcontractor. The Department reserves the right to require copies of actual subcontract agreements involving DBE subcontractors.

When using transportation services to meet the contract commitment, the Contractor shall submit a proposed trucking plan in addition to the SAF. The plan shall be submitted prior to beginning construction on the project. The plan shall include the names of all trucking firms proposed for use, their certification type(s), the number of trucks owned by the firm, as well as the individual truck identification numbers, and the line item(s) being performed.

Within 30 calendar days of entering into an agreement with a DBE for materials, supplies or services, not otherwise documented by the SAF as specified above, the Contractor shall furnish the Engineer a copy of the agreement. The documentation shall also indicate the percentage (60% or 100%) of expenditures claimed for DBE credit.

### **Reporting Disadvantaged Business Enterprise Participation**

The Contractor shall provide the Engineer with an accounting of payments made to all DBE firms, including material suppliers and contractors at all levels (prime, subcontractor, or second tier subcontractor). This accounting shall be furnished to the Engineer for any given month by the end of the following month. Failure to submit this information accordingly may result in the following action:

- (A) Withholding of money due in the next partial pay estimate; or
- (B) Removal of an approved contractor from the prequalified bidders' list or the removal of other entities from the approved subcontractors list.

While each contractor (prime, subcontractor, 2nd tier subcontractor) is responsible for accurate accounting of payments to DBEs, it shall be the prime contractor's responsibility to report all monthly and final payment information in the correct reporting manner.

Failure on the part of the Contractor to submit the required information in the time frame specified may result in the disqualification of that contractor and any affiliate companies from further bidding until the required information is submitted.

Failure on the part of any subcontractor to submit the required information in the time frame specified may result in the disqualification of that contractor and any affiliate companies from being approved for work on future projects until the required information is submitted.

Contractors reporting transportation services provided by non-DBE lessees shall evaluate the value of services provided during the month of the reporting period only.

At any time, the Engineer can request written verification of subcontractor payments.

The Contractor shall report the accounting of payments through the Department's DBE Payment Tracking System.

**Failure to Meet Contract Requirements**

Failure to meet contract requirements in accordance with Subarticle 102-15(J) of the *Standard Specifications* may be cause to disqualify the Contractor.

**CERTIFICATION FOR FEDERAL-AID CONTRACTS:**

(3-21-90)

SP1 G85

The prospective participant certifies, by signing and submitting this bid or proposal, to the best of his or her knowledge and belief, that:

- (A) No Federal appropriated funds have been paid or will be paid, by or on behalf of the undersigned, to any person for influencing or attempting to influence an officer or employee of any Federal agency, a Member of Congress, an officer or employee of Congress, or an employee of a Member of Congress in connection with the awarding of any Federal contract, the making of any Federal grant, the making of any Federal loan, the entering into of any cooperative agreement, and the extension, continuation, renewal, amendment, or modification of any Federal contract, grant, loan, or cooperative agreement.
- (B) If any funds other than Federal appropriated funds have been paid or will be paid to any person for influencing or attempting to influence an officer or employee of any Federal agency, a Member of Congress, an officer or employee of Congress, or an employee of a Member of Congress in connection with this Federal contract, grant, loan, or cooperative agreement, the undersigned shall complete and submit Standard Form-LLL, *Disclosure Form to Report Lobbying*, in accordance with its instructions.

This certification is a material representation of fact upon which reliance was placed when this transaction was made or entered into. Submission of this certification is a prerequisite for making or entering into this transaction imposed by *Section 1352, Title 31, U.S. Code*. Any person who fails to file the required certification shall be subject to a civil penalty of not less than \$10,000 and not more than \$100,000 for each such failure.

The prospective participant also agrees by submitting his or her bid or proposal that he or she shall require that the language of this certification be included in all lower tier subcontracts, which exceed \$100,000 and that all such subrecipients shall certify and disclose accordingly.

**RESTRICTIONS ON ITS EQUIPMENT AND SERVICES:**

(11-17-20)

SP01 G090

All telecommunications, video or other ITS equipment or services installed or utilized on this project must be in conformance with UNIFORM ADMINISTRATIVE REQUIREMENTS, COST PRINCIPLES, AND AUDIT REQUIREMENTS FOR FEDERAL AWARDS **2 CFR, § 200.216**  
**Prohibition on certain telecommunications and video surveillance services or equipment.**

**USE OF UNMANNED AIRCRAFT SYSTEM (UAS):**

(8-20-19)

SP1 G092

The Contractor shall adhere to all Federal, State and Local regulations and guidelines for the use of Unmanned Aircraft Systems (UAS). This includes but is not limited to US 14 CFR Part 107 *Small UAS Rule*, NC GS 15A-300.2 *Regulation of launch and recovery sites*, NC GS 63-95 *Training required for the operation of unmanned aircraft systems*, NC GS 63-96 *Permit required for commercial operation of unmanned aircraft system*, and NCDOT UAS Policy. The required operator certifications include possessing a current Federal Aviation Administration (FAA) Remote Pilot Certificate, a NC UAS Operator Permit as well as operating a UAS registered with the FAA.

Prior to beginning operations, the Contractor shall complete the NCDOT UAS – Flight Operation Approval Form and submit it to the Engineer for approval. All UAS operations shall be approved by the Engineer prior to beginning the operations.

All contractors or subcontractors operating UAS shall have UAS specific general liability insurance to cover all operations under this contract.

The use of UAS is at the Contractor's discretion. No measurement or payment will be made for the use of UAS. In the event that the Department directs the Contractor to utilize UAS, payment will be in accordance with Article 104-7 Extra Work.

**EQUIPMENT IDLING GUIDELINES:**

(1-19-21)

107

SP1 G096

Exercise reduced fuel consumption and reduced equipment emissions during the construction of all work associated with this contract. Employees engaged in the construction of this project should turn off vehicles when stopped for more than thirty (30) minutes and off-highway equipment should idle no longer than fifteen (15) consecutive minutes.

These guidelines for turning off vehicles and equipment when idling do not apply to:

1. Idling when queuing.
2. Idling to verify the vehicle is in safe operating condition.
3. Idling for testing, servicing, repairing or diagnostic purposes.
4. Idling necessary to accomplish work for which the vehicle was designed (such as operating a crane, mixing concrete, etc.).
5. Idling required to bring the machine system to operating temperature.
6. Emergency vehicles, utility company, construction, and maintenance vehicles where the engines must run to perform needed work.
7. Idling to ensure safe operation of the vehicle.
8. Idling when the propulsion engine is providing auxiliary power for other than heating or air conditioning. (such as hydraulic systems for pavers)
9. When specific traffic, safety, or emergency situations arise.
10. If the ambient temperature is less than 32 degrees Fahrenheit. Limited idling to provide for the safety of vehicle occupants (e.g. to run the heater).

11. If the ambient temperature is greater than 90 degrees Fahrenheit. Limited idling to provide for the safety of vehicle occupants of off-highway equipment (e.g. to run the air conditioning) no more than 30 minutes.
12. Diesel powered vehicles may idle for up to 30 minutes to minimize restart problems.

Any vehicle, truck, or equipment in which the primary source of fuel is natural gas or electricity is exempt from the idling limitations set forth in this special provision.

**U.S. DEPARTMENT OF TRANSPORTATION HOTLINE:**

(11-22-94)

108-5

SP1 G100

To report bid rigging activities call: **1-800-424-9071**

The U.S. Department of Transportation (DOT) operates the above toll-free hotline Monday through Friday, 8:00 a.m. to 5:00 p.m. eastern time. Anyone with knowledge of possible bid rigging, bidder collusion, or other fraudulent activities should use the hotline to report such activities.

The hotline is part of the DOT's continuing effort to identify and investigate highway construction contract fraud and abuse is operated under the direction of the DOT Inspector General. All information will be treated confidentially and caller anonymity will be respected.

**SUBSURFACE INFORMATION:**

(7-1-95)(Rev. 8-16-22)

450

SP1 G112 B

Subsurface information is available on the structure portion of this project.

**TWELVE MONTH GUARANTEE:**

(7-15-03)

108

SP1 G145

- (A) The Contractor shall guarantee materials and workmanship against latent and patent defects arising from faulty materials, faulty workmanship or negligence for a period of twelve months following the date of final acceptance of the work for maintenance and shall replace such defective materials and workmanship without cost to the Department. The Contractor will not be responsible for damage due to faulty design, normal wear and tear, for negligence on the part of the Department, and/or for use in excess of the design.
- (B) Where items of equipment or material carry a manufacturer's guarantee for any period in excess of twelve months, then the manufacturer's guarantee shall apply for that particular piece of equipment or material. The Department's first remedy shall be through the manufacturer although the Contractor is responsible for invoking the warranted repair work with the manufacturer. The Contractor's responsibility shall be limited to the term of the manufacturer's guarantee. NCDOT would be afforded the same warranty as provided by the Manufacturer.

This guarantee provision shall be invoked only for major components of work in which the Contractor would be wholly responsible for under the terms of the contract. Examples would include pavement structures, bridge components, and sign structures. This provision will not be used as a mechanism to force the Contractor to return to the project to make repairs or perform additional work that the Department would normally compensate the Contractor for. In addition,

routine maintenance activities (i.e. mowing grass, debris removal, ruts in earth shoulders,) are not parts of this guarantee.

Appropriate provisions of the payment and/or performance bonds shall cover this guarantee for the project.

To ensure uniform application statewide the Division Engineer will forward details regarding the circumstances surrounding any proposed guarantee repairs to the Chief Engineer for review and approval prior to the work being performed.

### **EROSION AND SEDIMENT CONTROL/STORMWATER CERTIFICATION:**

(1-16-07) (Rev 12-15-20)

105-16, 225-2, 16

SP1 G180

#### **General**

Schedule and conduct construction activities in a manner that will minimize soil erosion and the resulting sedimentation and turbidity of surface waters. Comply with the requirements herein regardless of whether or not a National Pollution discharge Elimination System (NPDES) permit for the work is required.

Establish a chain of responsibility for operations and subcontractors' operations to ensure that the *Erosion and Sediment Control/Stormwater Pollution Prevention Plan* is implemented and maintained over the life of the contract.

- (A) *Certified Supervisor* - Provide a certified Erosion and Sediment Control/Stormwater Supervisor to manage the Contractor and subcontractor operations, insure compliance with Federal, State and Local ordinances and regulations, and manage the Quality Control Program.
- (B) *Certified Foreman* - Provide a certified, trained foreman for each construction operation that increases the potential for soil erosion or the possible sedimentation and turbidity of surface waters.
- (C) *Certified Installer* - Provide a certified installer to install or direct the installation for erosion or sediment/stormwater control practices.
- (D) *Certified Designer* - Provide a certified designer for the design of the erosion and sediment control/stormwater component of reclamation plans and, if applicable, for the design of the project erosion and sediment control/stormwater plan.

#### **Roles and Responsibilities**

- (A) *Certified Erosion and Sediment Control/Stormwater Supervisor* - The Certified Supervisor shall be Level II and responsible for ensuring the erosion and sediment control/stormwater plan is adequately implemented and maintained on the project and for conducting the quality control program. The Certified Supervisor shall be on the project within 24 hours notice from initial exposure of an erodible surface to the project's final acceptance. Perform the following duties:

- (1) Manage Operations - Coordinate and schedule the work of subcontractors so that erosion and sediment control/stormwater measures are fully executed for each operation and in a timely manner over the duration of the contract.
  - (a) Oversee the work of subcontractors so that appropriate erosion and sediment control/stormwater preventive measures are conformed to at each stage of the work.
  - (b) Prepare the required National Pollutant Discharge Elimination System (NPDES) Inspection Record and submit to the Engineer.
  - (c) Attend all weekly or monthly construction meetings to discuss the findings of the NPDES inspection and other related issues.
  - (d) Implement the erosion and sediment control/stormwater site plans requested.
  - (e) Provide any needed erosion and sediment control/stormwater practices for the Contractor's temporary work not shown on the plans, such as, but not limited to work platforms, temporary construction, pumping operations, plant and storage yards, and cofferdams.
  - (f) Acquire applicable permits and comply with requirements for borrow pits, dewatering, and any temporary work conducted by the Contractor in jurisdictional areas.
  - (g) Conduct all erosion and sediment control/stormwater work in a timely and workmanlike manner.
  - (h) Fully perform and install erosion and sediment control/stormwater work prior to any suspension of the work.
  - (i) Coordinate with Department, Federal, State and Local Regulatory agencies on resolution of erosion and sediment control/stormwater issues due to the Contractor's operations.
  - (j) Ensure that proper cleanup occurs from vehicle tracking on paved surfaces or any location where sediment leaves the Right-of-Way.
  - (k) Have available a set of erosion and sediment control/stormwater plans that are initialed and include the installation date of Best Management Practices. These practices shall include temporary and permanent groundcover and be properly updated to reflect necessary plan and field changes for use and review by Department personnel as well as regulatory agencies.
  
- (2) Requirements set forth under the NPDES Permit - The Department's NPDES Stormwater permit (NCS000250) outlines certain objectives and management measures pertaining to construction activities. The permit references *NCG010000, General Permit to Discharge Stormwater* under the NPDES, and states that the Department shall incorporate the applicable requirements into its delegated Erosion and Sediment Control Program for construction activities disturbing one or more acres of land. The Department further incorporates these requirements on all contracted bridge and culvert work at jurisdictional waters, regardless of size. Some of the requirements are, but are not limited to:
  - (a) Control project site waste to prevent contamination of surface or ground waters of the state, i.e. from equipment operation/maintenance, construction



- materials, concrete washout, chemicals, litter, fuels, lubricants, coolants, hydraulic fluids, any other petroleum products, and sanitary waste.
- (b) Inspect erosion and sediment control/stormwater devices and stormwater discharge outfalls at least once every 7 calendar days and within 24 hours after a rainfall event equal to or greater than 1.0 inch that occurs within a 24 hour period. Additional monitoring may be required at the discretion of Division of Water Resources personnel if the receiving stream is 303(d) listed for turbidity and the project has had documented problems managing turbidity.
  - (c) Maintain an onsite rain gauge or use the Department's Multi-Sensor Precipitation Estimate website to maintain a daily record of rainfall amounts and dates.
  - (d) Maintain erosion and sediment control/stormwater inspection records for review by Department and Regulatory personnel upon request.
  - (e) Implement approved reclamation plans on all borrow pits, waste sites and staging areas.
  - (f) Maintain a log of turbidity test results as outlined in the Department's Procedure for Monitoring Borrow Pit Discharge.
  - (g) Provide secondary containment for bulk storage of liquid materials.
  - (h) Provide training for employees concerning general erosion and sediment control/stormwater awareness, the Department's NPDES Stormwater Permit NCS000250 requirements, and the applicable requirements of the *General Permit, NCG010000*.
  - (i) Report violations of the NPDES permit to the Engineer immediately who will notify the Division of Water Quality Regional Office within 24 hours of becoming aware of the violation.
- (3) Quality Control Program - Maintain a quality control program to control erosion, prevent sedimentation and follow provisions/conditions of permits. The quality control program shall:
- (a) Follow permit requirements related to the Contractor and subcontractors' construction activities.
  - (b) Ensure that all operators and subcontractors on site have the proper erosion and sediment control/stormwater certification.
  - (c) Notify the Engineer when the required certified erosion and sediment control/stormwater personnel are not available on the job site when needed.
  - (d) Conduct the inspections required by the NPDES permit.
  - (e) Take corrective actions in the proper timeframe as required by the NPDES permit for problem areas identified during the NPDES inspections.
  - (f) Incorporate erosion control into the work in a timely manner and stabilize disturbed areas with mulch/seed or vegetative cover on a section-by-section basis.
  - (g) Use flocculants approved by state regulatory authorities where appropriate and where required for turbidity and sedimentation reduction.
  - (h) Ensure proper installation and maintenance of temporary erosion and sediment control devices.

- (i) Remove temporary erosion or sediment control devices when they are no longer necessary as agreed upon by the Engineer.
- (j) The Contractor's quality control and inspection procedures shall be subject to review by the Engineer. Maintain NPDES inspection records and make records available at all times for verification by the Engineer.

(B) *Certified Foreman* - At least one Certified Foreman shall be onsite for each type of work listed herein during the respective construction activities to control erosion, prevent sedimentation and follow permit provisions:

- (1) Foreman in charge of grading activities
- (2) Foreman in charge of bridge or culvert construction over jurisdictional areas
- (3) Foreman in charge of utility activities

The Contractor may request to use the same person as the Level II Supervisor and Level II Foreman. This person shall be onsite whenever construction activities as described above are taking place. This request shall be approved by the Engineer prior to work beginning.

The Contractor may request to name a single Level II Foreman to oversee multiple construction activities on small bridge or culvert replacement projects. This request shall be approved by the Engineer prior to work beginning.

(C) *Certified Installers* - Provide at least one onsite, Level I Certified Installer for each of the following erosion and sediment control/stormwater crew:

- (1) Seeding and Mulching
- (2) Temporary Seeding
- (3) Temporary Mulching
- (4) Sodding
- (5) Silt fence or other perimeter erosion/sediment control device installations
- (6) Erosion control blanket installation
- (7) Hydraulic tackifier installation
- (8) Turbidity curtain installation
- (9) Rock ditch check/sediment dam installation
- (10) Ditch liner/matting installation
- (11) Inlet protection
- (12) Riprap placement
- (13) Stormwater BMP installations (such as but not limited to level spreaders, retention/detention devices)
- (14) Pipe installations within jurisdictional areas

If a Level I *Certified Installer* is not onsite, the Contractor may substitute a Level II Foreman for a Level I Installer, provided the Level II Foreman is not tasked to another crew requiring Level II Foreman oversight.

(D) *Certified Designer* - Include the certification number of the Level III Certified Designer on the erosion and sediment control/stormwater component of all reclamation plans and if

applicable, the certification number of the Level III Certified Designer on the design of the project erosion and sediment control/stormwater plan.

### **Preconstruction Meeting**

Furnish the names of the *Certified Erosion and Sediment Control/Stormwater Supervisor*, *Certified Foremen*, *Certified Installers* and *Certified Designer* and notify the Engineer of changes in certified personnel over the life of the contract within 2 days of change.

### **Ethical Responsibility**

Any company performing work for the North Carolina Department of Transportation has the ethical responsibility to fully disclose any reprimand or dismissal of an employee resulting from improper testing or falsification of records.

### **Revocation or Suspension of Certification**

Upon recommendation of the Chief Engineer to the certification entity, certification for *Supervisor*, *Certified Foremen*, *Certified Installers* and *Certified Designer* may be revoked or suspended with the issuance of an *Immediate Corrective Action (ICA)*, *Notice of Violation (NOV)*, or *Cease and Desist Order* for erosion and sediment control/stormwater related issues.

The Chief Engineer may recommend suspension or permanent revocation of certification due to the following:

- (A) Failure to adequately perform the duties as defined within this certification provision.
- (B) Issuance of an ICA, NOV, or Cease and Desist Order.
- (C) Failure to fully perform environmental commitments as detailed within the permit conditions and specifications.
- (D) Demonstration of erroneous documentation or reporting techniques.
- (E) Cheating or copying another candidate's work on an examination.
- (F) Intentional falsification of records.
- (G) Directing a subordinate under direct or indirect supervision to perform any of the above actions.
- (H) Dismissal from a company for any of the above reasons.
- (I) Suspension or revocation of one's certification by another entity.

Suspension or revocation of a certification will be sent by certified mail to the certificant and the Corporate Head of the company that employs the certificant.

A certificant has the right to appeal any adverse action which results in suspension or permanent revocation of certification by responding, in writing, to the Chief Engineer within 10 calendar days after receiving notice of the proposed adverse action.

Chief Engineer  
1536 Mail Service Center  
Raleigh, NC 27699-1536

Failure to appeal within 10 calendar days will result in the proposed adverse action becoming effective on the date specified on the certified notice. Failure to appeal within the time specified will result in a waiver of all future appeal rights regarding the adverse action taken. The certificant will not be allowed to perform duties associated with the certification during the appeal process.

The Chief Engineer will hear the appeal and make a decision within 7 days of hearing the appeal. Decision of the Chief Engineer will be final and will be made in writing to the certificant.

If a certification is temporarily suspended, the certificant shall pass any applicable written examination and any proficiency examination, at the conclusion of the specified suspension period, prior to having the certification reinstated.

### **Measurement and Payment**

*Certified Erosion and Sediment Control/Stormwater Supervisor, Certified Foremen, Certified Installers and Certified Designer* will be incidental to the project for which no direct compensation will be made.

### **PROCEDURE FOR MONITORING BORROW PIT DISCHARGE:**

(2-20-07) (Rev. 1-16-24)

105-16, 230, 801

SP1 G181

Water discharge from borrow pit sites shall not cause surface waters to exceed 50 NTUs (nephelometric turbidity unit) in streams not designated as trout waters and 10 NTUs in streams, lakes or reservoirs designated as trout waters. For lakes and reservoirs not designated as trout waters, the turbidity shall not exceed 25 NTUs. If the turbidity exceeds these levels due to natural background conditions, the existing turbidity level shall not be increased.

If during any operating day, the downstream water quality exceeds the standard, the Contractor shall do all of the following:

- (A) Either cease discharge or modify the discharge volume or turbidity levels to bring the downstream turbidity levels into compliance, or
- (B) Evaluate the upstream conditions to determine if the exceedance of the standard is due to natural background conditions. If the background turbidity measurements exceed the standard, operation of the pit and discharge can continue as long as the stream turbidity levels are not increased due to the discharge.
- (C) Measure and record the turbidity test results (time, date and sampler) at all defined sampling locations 30 minutes after startup and at a minimum, one additional sampling of all sampling locations during that 24-hour period in which the borrow pit is discharging.
- (D) Notify DWQ within 24 hours of any stream turbidity standard exceedances that are not brought into compliance.

During the Environmental Assessment required by Article 230-4 of the *Standard Specifications*, the Contractor shall define the point at which the discharge enters into the State's surface waters and the appropriate sampling locations. Sampling locations shall include points upstream and downstream from the point at which the discharge enters these waters. Upstream sampling

location shall be located so that it is not influenced by backwater conditions and represents natural background conditions. Downstream sampling location shall be located at the point where complete mixing of the discharge and receiving water has occurred.

The discharge shall be closely monitored when water from the dewatering activities is introduced into jurisdictional wetlands. Any time visible sedimentation (deposition of sediment) on the wetland surface is observed, the dewatering activity will be suspended until turbidity levels in the stilling basin can be reduced to a level where sediment deposition does not occur. Staining of wetland surfaces from suspended clay particles, occurring after evaporation or infiltration, does not constitute sedimentation. No activities shall occur in wetlands that adversely affect the functioning of a wetland. Visible sedimentation will be considered an indication of possible adverse impacts on wetland use.

The Engineer will perform independent turbidity tests on a random basis. These results will be maintained in a log within the project records. Records will include, at a minimum, turbidity test results, time, date and name of sampler. Should the Department's test results exceed those of the Contractor's test results, an immediate test shall be performed jointly with the results superseding the previous test results of both the Department and the Contractor.

The Contractor shall use the *NCDOT Turbidity Reduction Options for Borrow Pits Matrix*, available at <https://connect.ncdot.gov/resources/roadside/FieldOperationsDocuments/TurbidityReductionOptionSheet.pdf> to plan, design, construct, and maintain BMPs to address water quality standards. Tier I Methods include stilling basins which are standard compensatory BMPs. Other Tier I methods are noncompensatory and shall be used when needed to meet the stream turbidity standards. Tier II Methods are also noncompensatory and are options that may be needed for protection of rare or unique resources or where special environmental conditions exist at the site which have led to additional requirements being placed in the DWQ's 401 Certifications and approval letters, Isolated Wetland Permits, Riparian Buffer Authorization or a DOT Reclamation Plan's Environmental Assessment for the specific site. Should the Contractor exhaust all Tier I Methods on a site exclusive of rare or unique resources or special environmental conditions, Tier II Methods may be required by regulators on a case by case basis per supplemental agreement.

The Contractor may use cation exchange capacity (CEC) values from proposed site borings to plan and develop the bid for the project. CEC values exceeding 15 milliequivalents per 100 grams of soil may indicate a high potential for turbidity and should be avoided when dewatering into surface water is proposed.

No additional compensation for monitoring borrow pit discharge will be paid.

**PROJECT SPECIAL PROVISIONS****ROADWAY**

**NOTES TO CONTRACTOR:** Erosion control products that incorporate plastic or nylon mesh and/or plastic or nylon twine shall not be used on this project.

(3-19-24)

200

SP2 R02B

**CLEARING AND GRUBBING – MODIFIED METHOD III:**

Perform clearing on this project to the limits established by Modified Method - III shown on Standard Drawing No. 200.03 of the *Roadway Standard Drawings*. Conventional clearing methods may be used except where permit drawings or conditions have been included in the proposal which require certain areas to be cleared by hand methods.

422

SP4 R02

**BRIDGE APPROACH FILLS:**

(10-19-10)(Rev. 1-16-24)

**Description**

Bridge approach fills consist of backfilling behind bridge end bents with select material or aggregate to support all or part of bridge approach slabs. Install outlets and grade bridge approach fills to drain water through and away from approach fills. Install geotextiles to allow for possible future slab jacking and separate approach fills from embankment fills, natural ground and pavement sections as required. For bridge approach fills behind end bents with mechanically stabilized earth (MSE) abutment walls, reinforce bridge approach fills with MSE wall reinforcement connected to end bent caps as required. Construct bridge approach fills in accordance with the contract, accepted submittals and bridge approach fill *Roadway Standard Drawings*.

Define bridge approach fill types as follows:

*Type 1 Approach Fill* – Approach fill for bridge abutment in accordance with *Roadway Standard Drawing* No. 423.01;

*Type 1A Approach Fill* – Alternate approach fill for integral bridge abutment in accordance with *Roadway Standard Drawing* No. 423.02;

*Type 2 Approach Fill* – Approach fill for bridge abutment with MSE wall in accordance with *Roadway Standard Drawing* No. 423.03 and

*Type 2A Approach Fill* – Alternate approach fill for integral bridge abutment with MSE wall in accordance with *Roadway Standard Drawing* No. 423.04.

At the Contractors option, use Type 1A or 2A approach fills instead of Type 1 or 2 approach fills, respectively, for integral bridge abutments. Type 1A and 2A approach fills consists of constructing an approach fill with a temporary geotextile wall before placing all or a portion of the concrete for the backwall and wing walls of the integral end bent cap. The temporary geotextile wall is designed for a construction surcharge, remains in place and is aligned so the wall face functions as a form for the integral end bent cap backwall and wing walls.

**Materials**

Refer to Division 10 of the *Standard Specifications*.

<b>Item</b>	<b>Section</b>
Geotextiles	1056
Portland Cement Concrete	1000
Select Materials	1016
Subsurface Drainage Materials	1044
Welded Wire Reinforcement	1070-3

Provide Type 1 geotextile for separation geotextiles, Type 4a geotextile for under bridge approach slabs and Class B concrete for outlet pads. Use Class V or Class VI select material for Type 1 and 1A approach fills and the same aggregate type approved for the reinforced zone in the accepted MSE wall submittal for Type 2 and 2A approach fills. For MSE wall aggregate, reinforcement and connector materials, see the *Mechanically Stabilized Earth Retaining Walls* provision. Provide outlet pipes and fittings for subsurface drainage materials. Provide 1/4" hardware cloth with 1/4 inch openings constructed from 24 gauge wire.

For temporary geotextile walls, use welded wire reinforcement for welded wire facing and Type 5a geotextile for reinforcement geotextiles. Use Type 5a geotextile with lengths as shown in *Roadway Standard Drawing* No. 423.02 or 423.04.

### **Construction Methods**

Excavate as necessary for approach fills and, if applicable, temporary geotextile walls in accordance with the contract. Ensure limits of approach fills are graded to drain as shown in the bridge approach fill *Roadway Standard Drawings*. For Type 1 and 1A approach fills in embankment fills, place and compact a temporary 1.5:1 (H:V) fill slope in accordance with *Roadway Standard Drawing* No. 423.01 or 423.02 and in accordance with Subarticle 235-3(B) and 235-3(C) of the *Standard Specifications*. Density testing is required within the temporary fill slope and additional more frequent density testing is also required for bridge approach embankments. Wait 3 days before cutting the slope back to complete the approach fill excavation. Use excavated material elsewhere on the project to form embankments, subgrades, or shoulders. If a slope for an approach fill is excavated to flatter than what is required for access or any other reason, that same slope is required for the entire approach fill excavation. Do not backfill overexcavations that extend outside the approach fill limits shown on the *Roadway Standard Drawings* with embankment soils. Instead, expand approach fill limits to include overexcavations.

Notify the Engineer when embankment fill placement and approach fill excavation is complete. Do not place separation geotextiles or aggregate until approach fill dimensions and embankment materials below and outside approach fills are approved.

For Type 2 approach fills, cast MSE wall reinforcement or connectors into end bent cap backwalls within 3 inches of locations shown in the accepted MSE wall submittals. Install MSE wall reinforcement with the orientation, dimensions and number of layers shown in the accepted MSE wall submittals. If a Type 2 approach fill is designed with geogrid reinforcement embedded in an end bent cap, cut geogrids to the required lengths and after securing ends of geogrids in place, reroll and rewrap portions of geogrids not embedded in the cap to protect geogrids from damage.

Before placing aggregate over any MSE wall geosynthetic reinforcement, pull reinforcement taut so that it is in tension and free of kinks, folds, wrinkles or creases.

For Type 1 and 1A approach fills, place pipe sleeves in wing walls so water drains towards outlets. Use sleeves that can withstand wing wall loads. Insert outlet pipes into pipe sleeves to direct water towards outlets. Attach hardware cloth in front of the outlet pipe at the wing. Connect outlet pipes and fittings with solvent cement in accordance with Article 815-3 of the *Standard Specifications* and place outlet pads in accordance with Roadway Standard Drawing No. 815.03.

Attach separation geotextiles to end bent cap backwalls and wing walls with adhesives, tapes or other approved methods. Overlap adjacent geotextiles of the same type at least 18 inches. Cover select material or aggregate with Type 4a geotextile at an elevation 6 inches below the bridge approach slab. Hold geotextiles in place with wire staples or anchor pins as needed. Contact the Engineer when existing or future obstructions such as foundations, pavements, pipes, inlets or utilities will interfere with geotextiles or MSE wall reinforcement.

For Type 1A and 2A approach fills, install temporary geotextile walls as shown in *Roadway Standard Drawing* No. 423.02 or 423.04. At the Contractor's option, construct the bottom portion of integral end bents before temporary geotextile walls as shown in the plans. Erect and set welded wire facing for temporary geotextile walls so facing functions as a form for the integral end bent cap backwall. Place welded wire facing adjacent to each other in the horizontal and vertical directions to completely cover the temporary geotextile wall face. Stagger welded wire facing to create a running bond by centering facing over joints in the row below. Wrap reinforcement geotextiles at the wall face in accordance with *Roadway Standard Drawing* No. 423.02 or 423.04 and cover geotextiles with at least 3 inches of select material or aggregate. Place layers of reinforcement geotextiles within 3 inches of locations shown in *Roadway Standard Drawing* No. 423.02 or 423.04. Install reinforcement geotextiles with the direction shown in *Roadway Standard Drawing* No. 423.02 or 423.04. Orient overlapping seams in reinforcement geotextiles perpendicular to the integral end bent cap backwall. Do not overlap reinforcement geotextiles so seams are parallel to the wall face. Before placing select material or aggregate over reinforcement geotextiles, pull geotextiles taut so they are in tension and free of kinks, folds, wrinkles or creases. Temporary geotextile walls are designed for a surcharge pressure in accordance with *Roadway Standard Drawing* No. 423.02 or 423.04. If loads from construction equipment will be more than what the wall is designed for, contact the Engineer before positioning equipment on top of temporary geotextile walls.

Place select material or aggregate in 6 inch to 8 inch thick lifts. Compact fine aggregate for Type 2 and 2A approach fills in accordance with Subarticle 235-3(C) of the *Standard Specifications* except compact fine aggregate to a density of at least 98%. Compact select material for Type 1 and 1A approach fills and coarse aggregate for Type 2 and 2A approach fills with at least 4 passes of a trench roller in a direction parallel to the end bent cap backwall. Do not displace or damage geosynthetics or MSE wall reinforcement when placing and compacting select material or aggregate. End dumping directly on geosynthetics is not permitted. Do not operate heavy equipment on geosynthetics until they are covered with at least 8 inches of select material or aggregate. Replace any damaged geosynthetics to the satisfaction of the Engineer. When approach fills extend beyond bridge approach slabs, wrap Type 4a geotextiles over select material or aggregate and back under approach slabs as shown in *Roadway Standard Drawing* No. 423.03 or 423.04.



**Measurement and Payment**

Type 1 and 1A approach fills will be paid for at the contract lump sum price for *Type 1 Bridge Approach Fill, Station \_\_\_\_\_* and Type 2 and 2A approach fills will be paid for at the contract lump sum price for *Type 2 Bridge Approach Fill, Station \_\_\_\_\_*. The lump sum price for each approach fill will be full compensation for providing labor, tools, equipment and approach fill materials, excavating, backfilling, hauling and removing excavated materials, installing wall facing, geotextiles and outlets, compacting backfill and supplying select material, aggregate, geotextiles, pipe sleeves, outlet pipes and pads and any incidentals necessary to construct approach fills behind bridge end bents.

Compensation for the material placed within the temporary 1.5:1 (H:V) fill slopes will be made in accordance with Section 225, 226, or 230 of the *Standard Specifications*. The cost of removal, including excavating, hauling, placement, and compaction of the material elsewhere on or off the project will be included in the contract lump sum price for *Type 1 Bridge Approach Fill, Station \_\_\_\_\_*.

The contract lump sum price for *Type 2 Bridge Approach Fill, Station \_\_\_\_\_* will also be full compensation for supplying and connecting MSE wall reinforcement to end bent caps but not designing MSE wall reinforcement and connectors. The cost of designing reinforcement and connectors for Type 2 approach fills behind bridge end bents with MSE abutment walls will be incidental to the contract unit price for *MSE Retaining Wall No. \_\_\_\_\_*.

Payment will be made under:

<b>Pay Item</b>	<b>Pay Unit</b>
Type 1 Bridge Approach Fill, Station _____	Lump Sum
Type 2 Bridge Approach Fill, Station _____	Lump Sum

**INCIDENTAL STONE BASE:**

(7-1-95)(Rev.1-16-24)

545

SP5 R28R

**Description**

Place incidental stone base on driveways, mailboxes, etc. immediately after paving and do not have the paving operations exceed stone base placement by more than one week without written permission of the Engineer.

**Materials and Construction**

Provide and place incidental stone base in accordance with Section 545 of the *Standard Specifications*.

**Measurement and Payment**

*Incidental Stone Base* will be measured and paid in accordance with Article 545-6 of the *Standard Specifications*.

**PRICE ADJUSTMENT - ASPHALT BINDER FOR PLANT MIX:**

(11-21-00)(Rev. 1-16-24)

620

SP6 R25

Price adjustments for asphalt binder for plant mix will be made in accordance with Section 620 of the *Standard Specifications*.

The base price index for asphalt binder for plant mix is \$ **596.88** per ton.

This base price index represents an average of F.O.B. selling prices of asphalt binder at supplier's terminals on **May 1, 2024**.

**FINAL SURFACE TESTING NOT REQUIRED:**

(5-18-04) (Rev. 2-16-16)

610

SP6 R45

Final surface testing is not required on this project in accordance with Section 610-13, *Final Surface Testing and Acceptance*.

**WATTLE DEVICES:**

(1-1-24)

1642

SP16 R01

**Page 16-23, Subarticle 1642-2(B) Wattle**, lines 10-12, delete and replace with the following:

**(B) Wattle and Wattle Barrier**

Wattles shall meet Table 1642-1.

<b>TABLE 1642-1</b>	
<b>100% CURLED WOOD (EXCELSIOR) FIBERS - WATTLE</b>	
<b>Property</b>	<b>Property Value</b>
Minimum Diameter	12 inches
Minimum Density	2.5 pcf +/- 10%
Net Material	Synthetic
Net Openings	1 inch x 1 inch
Net Configuration	Totally Encased
Minimum Weight	20 lb +/- 10% per 10 foot length

Coir Fiber Wattles shall meet Table 1642-2.

<b>TABLE 1642-2</b>	
<b>100% COIR (COCONUT) FIBERS WATTLE</b>	
<b>Property</b>	<b>Property Value</b>
Minimum Diameter	12 inches
Minimum Density	3.5 pcf +/- 10%
Net Material	Coir Fiber
Net Openings	2 inch x 2 inch
Net Strength	90 lb
Minimum Weight	2.6 pcf +/- 10%

Wattle Barriers shall meet Table 1642-3.

<b>TABLE 1642-3</b>	
<b>100% CURLED WOOD (EXCELSIOR) FIBERS – WATTLE BARRIER</b>	
<b>Property</b>	<b>Property Value</b>
Minimum Diameter	18 inches
Minimum Density	2.9 pcf +/- 10%
Net Material	Synthetic
Net Openings	1 inch x 1 inch
Net Configuration	Totally Encased
Minimum Weight	5 pcf +/- 10%

Coir Fiber Wattle Barriers shall meet Table 1642-4.

<b>TABLE 1642-4</b>	
<b>100% COIR (COCONUT) FIBERS WATTLE BARRIER</b>	
<b>Property</b>	<b>Property Value</b>
Minimum Diameter	18 inches
Minimum Density	5 pcf +/- 10%
Net Material	Coir Fiber
Net Openings	2 inch x 2 inch
Net Strength	90 lb
Minimum Weight	10 pcf +/- 10%

**Pages 16-24 & 16-25, Article 1642-5 MEASUREMENT AND PAYMENT**, lines 42-47 & lines 1-2, delete and replace with the following:

*Wattle* will be measured and paid for by the actual number of linear feet of wattles which are installed and accepted. Such price and payment will be full compensation for all work covered by this section, including, but not limited to, furnishing all materials, labor, equipment and incidentals necessary to install the *Wattle*.

*Coir Fiber Wattles* will be measured and paid for by the actual number of linear feet of coir fiber wattles which are installed and accepted. Such price and payment will be full compensation for all work covered by this section, including, but not limited to, furnishing all materials, labor, equipment and incidentals necessary to install the *Coir Fiber Wattles*.

*Wattle Barrier* will be measured and paid as the actual number of linear feet of wattle barrier installed and accepted. Such price and payment will be full compensation for all work covered by this provision, including, but not limited to, furnishing all materials, labor, equipment and incidentals necessary to install the *Wattle Barrier*.

*Coir Fiber Wattle Barrier* will be measured and paid as the actual number of linear feet of coir fiber wattle barrier installed and accepted. Such price and payment will be full compensation for all work covered by this provision, including, but not limited to, furnishing all materials, labor, equipment and incidentals necessary to install the *Coir Fiber Wattle Barrier*.

**Page 16-25, Article 1642-5 MEASUREMENT AND PAYMENT**, after line 9, delete and replace “ \_\_\_ Wattle Check” with “Wattle”.

**Page 16-25, Article 1642-5 MEASUREMENT AND PAYMENT**, after line 9, delete and replace “ \_\_\_ Wattle Barrier” with “Wattle Barrier”.

**Page 16-25, Article 1642-5 MEASUREMENT AND PAYMENT**, after line 9, add the following:

<b>Pay Item</b>	<b>Pay Unit</b>
Coir Fiber Wattle	Linear Foot
Coir Fiber Wattle Barrier	Linear Foot

**PERMANENT SEEDING AND MULCHING:**

(7-1-95)(Rev. 1-16-24)

1660

SP16 R02

The Department desires that permanent seeding and mulching be established on this project as soon as practical after slopes or portions of slopes have been graded. As an incentive to obtain an early stand of vegetation on this project, the Contractor's attention is called to the following:

For all permanent seeding and mulching that is satisfactorily completed in accordance with the requirements of Section 1660 in the *Standard Specifications* and within the following percentages of elapsed contract times, an additional payment will be made to the Contractor as an incentive additive. The incentive additive will be determined by multiplying the number of acres of seeding and mulching satisfactorily completed times the contract unit bid price per acre for Seeding and Mulching times the appropriate percentage additive.

Percentage of Elapsed Contract Time	Percentage Additive
0% - 30%	30%
30.01% - 50%	15%

Percentage of elapsed contract time is defined as the number of calendar days from the date of availability of the contract to the date the permanent seeding and mulching is acceptably completed divided by the total original contract time.

**STANDARD SPECIAL PROVISION**  
**AVAILABILITY OF FUNDS – TERMINATION OF CONTRACTS**

(5-20-08)(Rev. 1-16-24)

Z-2

*General Statute 143C-6-11. (h) Highway Appropriation* is hereby incorporated verbatim in this contract as follows:

(h) Amounts Encumbered. – Transportation project appropriations may be encumbered in the amount of allotments made to the Department of Transportation by the Director for the estimated payments for transportation project contract work to be performed in the appropriation fiscal year. The allotments shall be multiyear allotments and shall be based on estimated revenues and shall be subject to the maximum contract authority contained in *General Statute 143C-6-11(c)*. Payment for transportation project work performed pursuant to contract in any fiscal year other than the current fiscal year is subject to appropriations by the General Assembly. Transportation project contracts shall contain a schedule of estimated completion progress, and any acceleration of this progress shall be subject to the approval of the Department of Transportation provided funds are available. The State reserves the right to terminate or suspend any transportation project contract, and any transportation project contract shall be so terminated or suspended if funds will not be available for payment of the work to be performed during that fiscal year pursuant to the contract. In the event of termination of any contract, the contractor shall be given a written notice of termination at least 60 days before completion of scheduled work for which funds are available. In the event of termination, the contractor shall be paid for the work already performed in accordance with the contract specifications.

Payment will be made on any contract terminated pursuant to the special provision in accordance with Subarticle 108-13(D) of the *Standard Specifications*.

**STANDARD SPECIAL PROVISION**  
**NCDOT GENERAL SEED SPECIFICATION FOR SEED QUALITY**

(5-17-11)

Z-3

Seed shall be sampled and tested by the North Carolina Department of Agriculture and Consumer Services, Seed Testing Laboratory. When said samples are collected, the vendor shall supply an independent laboratory report for each lot to be tested. Results from seed so sampled shall be final. Seed not meeting the specifications shall be rejected by the Department of Transportation and shall not be delivered to North Carolina Department of Transportation warehouses. If seed has been delivered it shall be available for pickup and replacement at the supplier's expense.

Any re-labeling required by the North Carolina Department of Agriculture and Consumer Services, Seed Testing Laboratory, that would cause the label to reflect as otherwise specified herein shall be rejected by the North Carolina Department of Transportation.

Seed shall be free from seeds of the noxious weeds Johnsongrass, Balloonvine, Jimsonweed, Witchweed, Itchgrass, Serrated Tussock, Showy Crotalaria, Smooth Crotalaria, Sicklepod, Sandbur, Wild Onion, and Wild Garlic. Seed shall not be labeled with the above weed species on the seed analysis label. Tolerances as applied by the Association of Official Seed Analysts will NOT be allowed for the above noxious weeds except for Wild Onion and Wild Garlic.

Tolerances established by the Association of Official Seed Analysts will generally be recognized. However, for the purpose of figuring pure live seed, the found pure seed and found germination percentages as reported by the North Carolina Department of Agriculture and Consumer Services, Seed Testing Laboratory will be used. Allowances, as established by the NCDOT, will be recognized for minimum pure live seed as listed on the following pages.

The specifications for restricted noxious weed seed refers to the number per pound as follows:

<u>Restricted Noxious Weed</u>	<u>Limitations per Lb. Of Seed</u>	<u>Restricted Noxious Weed</u>	<u>Limitations per Lb. of Seed</u>
Blessed Thistle	4 seeds	Cornflower (Ragged Robin)	27 seeds
Cocklebur	4 seeds	Texas Panicum	27 seeds
Spurred Anoda	4 seeds	Bracted Plantain	54 seeds
Velvetleaf	4 seeds	Buckhorn Plantain	54 seeds
Morning-glory	8 seeds	Broadleaf Dock	54 seeds
Corn Cockle	10 seeds	Curly Dock	54 seeds
Wild Radish	12 seeds	Dodder	54 seeds
Purple Nutsedge	27 seeds	Giant Foxtail	54 seeds
Yellow Nutsedge	27 seeds	Horsenettle	54 seeds
Canada Thistle	27 seeds	Quackgrass	54 seeds
Field Bindweed	27 seeds	Wild Mustard	54 seeds
Hedge Bindweed	27 seeds		

Seed of Pensacola Bahiagrass shall not contain more than 7% inert matter, Kentucky Bluegrass, Centipede and Fine or Hard Fescue shall not contain more than 5% inert matter whereas a maximum of 2% inert matter will be allowed on all other kinds of seed. In addition, all seed shall

not contain more than 2% other crop seed nor more than 1% total weed seed. The germination rate as tested by the North Carolina Department of Agriculture shall not fall below 70%, which includes both dormant and hard seed. Seed shall be labeled with not more than 7%, 5% or 2% inert matter (according to above specifications), 2% other crop seed and 1% total weed seed.

Exceptions may be made for minimum pure live seed allowances when cases of seed variety shortages are verified. Pure live seed percentages will be applied in a verified shortage situation. Those purchase orders of deficient seed lots will be credited with the percentage that the seed is deficient.

FURTHER SPECIFICATIONS FOR EACH SEED GROUP ARE GIVEN BELOW:

Minimum 85% pure live seed; maximum 1% total weed seed; maximum 2% total other crop seed; maximum 144 restricted noxious weed seed per pound. Seed less than 83% pure live seed will not be approved.

Sericea Lespedeza  
Oats (seeds)

Minimum 80% pure live seed; maximum 1% total weed seed; maximum 2% total other crop; maximum 144 restricted noxious weed seed per pound. Seed less than 78% pure live seed will not be approved.

Tall Fescue (all approved varieties)	Bermudagrass
Kobe Lespedeza	Browntop Millet
Korean Lespedeza	German Millet – Strain R
Weeping Lovegrass	Clover – Red/White/Crimson
Carpetgrass	

Minimum 78% pure live seed; maximum 1% total weed seed; maximum 2% total other crop seed; maximum 144 restricted noxious weed seed per pound. Seed less than 76% pure live seed will not be approved.

Common or Sweet Sundangrass

Minimum 76% pure live seed; maximum 1% total weed seed; maximum 2% total other crop seed; maximum 144 restricted noxious weed seed per pound. Seed less than 74% pure live seed will not be approved.

Rye (grain; all varieties)  
Kentucky Bluegrass (all approved varieties)  
Hard Fescue (all approved varieties)  
Shrub (bicolor) Lespedeza

Minimum 70% pure live seed; maximum 1% total weed seed; maximum 2% total other crop seed; maximum 144 noxious weed seed per pound. Seed less than 70% pure live seed will not be approved.

Centipedegrass	Japanese Millet
Crownvetch	Reed Canary Grass
Pensacola Bahiagrass	Zoysia
Creeping Red Fescue	

Minimum 70% pure live seed; maximum 1% total weed seed; maximum 2% total other crop seed; maximum 5% inert matter; maximum 144 restricted noxious weed seed per pound.

Barnyard Grass  
Big Bluestem  
Little Bluestem  
Bristly Locust  
Birdsfoot Trefoil  
Indiangrass  
Orchardgrass  
Switchgrass  
Yellow Blossom Sweet Clover



**STANDARD SPECIAL PROVISION**  
**ERRATA**

(1-16-24)

Z-4

Revise the *2024 Standard Specifications* as follows:

**Division 3**

**Page 3-5, Article 305-2 MATERIALS, after line 16,** replace " 1032-3(A)(7)" with "1032-3" and add the item "Galvanized Corrugated Steel Pipe" with Section "1032-3".

**Page 3-6, Article 310-2 MATERIALS, after line 9,** add the item "Galvanized Corrugated Steel Pipe" with Section "1032-3".

**Division 9**

**Page 9-17, Article 904-4 MEASUREMENT AND PAYMENT, prior to line 1,** replace " Sign Erection, Relocate Type (Ground Mounted)" with "Sign Erection, Relocate Type \_\_\_ (Ground Mounted)".

**Division 10**

**Page 10-51, Article 1024-4 WATER, prior to line 1,** delete the "unpopulated blank row" in Table 1024-2 between "Time of set, deviation from control" and "Chloride Ion Content, Max.".

**Page 10-170, Subarticle 1081-1(C) Requirements, line 4,** replace "maximum" with "minimum".

**Division 11**

**Page 11-15, Article 1160-4 MEASUREMENT AND PAYMENT, line 24,** replace "Where barrier units are moved more than one" with "Where barrier units are moved more than once".

**Division 15**

**Page 15-10, Article 1515-4 MEASUREMENT AND PAYMENT, lines 11,** replace " All piping" with "All labor, the manhole, other materials, excavation, backfilling, piping".

**Division 16**

**Page 16-14, Article 1633-5 MEASUREMENT AND PAYMENT, line 20-24 and prior to line 25,** delete and replace with the following " *Flocculant* will be measured and paid in accordance with Article 1642-5 applied to the temporary rock silt checks."

**Page 16-3, Article 1609-2 MATERIALS, after line 26,** replace "Type 4" with "Type 4a".

**Page 16-25, Article 1644-2 MATERIALS, after line 22,** replace "Type 4" with "Type 4a".

**STANDARD SPECIAL PROVISION****PLANT AND PEST QUARANTINES****(Imported Fire Ant, Gypsy Moth, Witchweed, Emerald Ash Borer, Guava Root Knot Nematode, And Other Noxious Weeds)**

(3-18-03) (Rev. 5-21-19)

Z-04a

**Within Quarantined Area**

This project may be within a county regulated for plant and/or pests. If the project or any part of the Contractor's operations is located within a quarantined area, thoroughly clean all equipment prior to moving out of the quarantined area. Comply with federal/state regulations by obtaining a certificate or limited permit for any regulated article moving from the quarantined area.

**Originating in a Quarantined County**

Obtain a certificate or limited permit issued by the N.C. Department of Agriculture/United States Department of Agriculture. Have the certificate or limited permit accompany the article when it arrives at the project site.

**Contact**

Contact the N.C. Department of Agriculture/United States Department of Agriculture at 1-800-206-9333, 919-707-3730, or <https://www.ncagr.gov/plantindustry/Plant/quaran/table2.htm> to determine those specific project sites located in the quarantined area or for any regulated article used on this project originating in a quarantined county.

**Regulated Articles Include**

1. Soil, sand, gravel, compost, peat, humus, muck, and decomposed manure, separately or with other articles. This includes movement of articles listed above that may be associated with cut/waste, ditch pulling, and shoulder cutting.
2. Plants with roots including grass sod.
3. Plant crowns and roots.
4. Bulbs, corms, rhizomes, and tubers of ornamental plants.
5. Hay, straw, fodder, and plant litter of any kind.
6. Clearing and grubbing debris.
7. Used agricultural cultivating and harvesting equipment.
8. Used earth-moving equipment.
9. Any other products, articles, or means of conveyance, of any character, if determined by an inspector to present a hazard of spreading imported fire ant, gypsy moth, witchweed, emerald ash borer, guava root knot nematode, or other noxious weeds.

**STANDARD SPECIAL PROVISION****TITLE VI AND NONDISCRIMINATION:**

(6-28-77)(Rev 1/16/2024)

Z-6

The North Carolina Department of Transportation is committed to carrying out the U.S. Department of Transportation's policy of ensuring nondiscrimination in the award and administration of contracts.

The provisions of this section related to United States Department of Transportation (US DOT) Order 1050.2A, Title 49 Code of Federal Regulations (CFR) part 21, 23 United States Code (U.S.C.) 140 and 23 CFR part 200 (or 49 CFR 303, 49 U.S.C. 5332 or 49 U.S.C. 47123) are applicable to all North Carolina Department of Transportation (NCDOT) contracts and to all related subcontracts, material supply, engineering, architectural and other service contracts, regardless of dollar amount. Any Federal provision that is specifically required not specifically set forth is hereby incorporated by reference.

**(1) Title VI Assurances (USDOT Order 1050.2A, Appendix A)**

During the performance of this contract, the contractor, for itself, its assignees, and successors in interest (hereinafter referred to as the "contractor") agrees as follows:

**(a) Compliance with Regulations**

The contractor (hereinafter includes consultants) shall comply with the Acts and the Regulations relative to Nondiscrimination in Federally-assisted programs of the U.S. Department of Transportation, Federal Highway Administration (FHWA), as they may be amended from time to time, which are herein incorporated by reference and made a part of this contract.

**(b) Nondiscrimination**

The contractor, with regard to the work performed by it during the contract, shall not discriminate on the grounds of race, color, or national origin in the selection and retention of subcontractors, including procurements of materials and leases of equipment. The contractor shall not participate directly or indirectly in the discrimination prohibited by the Acts and the Regulations, including employment practices when the contract covers any activity, project, or program set forth in Appendix B of 49 CFR Part 21.

**(c) Solicitations for Subcontractors, Including Procurements of Materials and Equipment**

In all solicitations, either by competitive bidding, or negotiation made by the contractor for work to be performed under a subcontract, including procurements of materials, or leases of equipment, each potential subcontractor or supplier shall be notified by the contractor of the contractor's obligations under this contract and the Acts and the Regulations relative to Nondiscrimination on the grounds of race, color, or national origin.

**(d) Information and Reports**

The contractor shall provide all information and reports required by the Acts, the Regulations, and directives issued pursuant thereto and shall permit access to its books, records, accounts, other sources of information, and its facilities as may be determined

by the Recipient or the FHWA to be pertinent to ascertain compliance with such Acts, Regulations, and instructions. Where any information required of a contractor is in the exclusive possession of another who fails or refuses to furnish the information, the contractor shall so certify to the Recipient or the FHWA, as appropriate, and shall set forth what efforts it has made to obtain the information.

(e) Sanctions for Noncompliance:

In the event of a contractor's noncompliance with the Non-discrimination provisions of this contract, the Recipient will impose such contract sanctions as it and/or the FHWA may determine to be appropriate, including, but not limited to:

- (i) Withholding payments to the contractor under the contract until the contractor complies; and/or
- (ii) Cancelling, terminating, or suspending a contract, in whole or in part.

(f) Incorporation of Provisions

The contractor shall include the provisions of paragraphs (a) through (f) in every subcontract, including procurements of materials and leases of equipment, unless exempt by the Acts, the Regulations and directives issued pursuant thereto. The contractor shall take action with respect to any subcontract or procurement as the Recipient or the FHWA may direct as a means of enforcing such provisions including sanctions for noncompliance. Provided, that if the contractor becomes involved in, or is threatened with litigation by a subcontractor, or supplier because of such direction, the contractor may request the Recipient to enter into any litigation to protect the interests of the Recipient. In addition, the contractor may request the United States to enter into the litigation to protect the interests of the United States.

**(2) Title VI Nondiscrimination Program (23 CFR 200.5(p))**

The North Carolina Department of Transportation (NCDOT) has assured the USDOT that, as a condition to receiving federal financial assistance, NCDOT will comply with Title VI of the Civil Rights Act of 1964 and all requirements imposed by Title 49 CFR part 21 and related nondiscrimination authorities to ensure that no person shall, on the ground of race, color, national origin, limited English proficiency, sex, age, or disability (including religion/creed or income-level, where applicable), be excluded from participation in, be denied the benefits of, or be subjected to discrimination under any programs, activities, or services conducted or funded by NCDOT. Contractors and other organizations under contract or agreement with NCDOT must also comply with Title VI and related authorities, therefore:

- (a) During the performance of this contract or agreement, contractors (e.g., subcontractors, consultants, vendors, prime contractors) are responsible for complying with NCDOT's Title VI Program. Contractors are not required to prepare or submit Title VI Programs. To comply with this section, the prime contractor shall:
  - 1. Post NCDOT's Notice of Nondiscrimination and the Contractor's own Equal Employment Opportunity (EEO) Policy in conspicuous locations accessible to all employees, applicants and subcontractors on the jobsite.

2. Physically incorporate the required Title VI clauses into all subcontracts on federally-assisted and state-funded NCDOT projects, and ensure inclusion by subcontractors into all lower-tier subcontracts.
  3. Required Solicitation Language. The Contractor shall include the following notification in all solicitations for bids and requests for work or material, regardless of funding source:

“The North Carolina Department of Transportation, in accordance with the provisions of Title VI of the Civil Rights Act of 1964 (78 Stat. 252, 42 U.S.C. §§ 2000d to 2000d-4) and the Regulations, hereby notifies all bidders that it will affirmatively ensure that any contract entered into pursuant to this advertisement, disadvantaged business enterprises will be afforded full and fair opportunity to submit bids in response to this invitation and will not be discriminated against on the grounds of race, color, or national origin in consideration for an award. In accordance with other related nondiscrimination authorities, bidders and contractors will also not be discriminated against on the grounds of sex, age, disability, low-income level, creed/religion, or limited English proficiency in consideration for an award.”
  4. Physically incorporate the FHWA-1273, in its entirety, into all subcontracts and subsequent lower tier subcontracts on Federal-aid highway construction contracts only.
  5. Provide language assistance services (i.e., written translation and oral interpretation), free of charge, to LEP employees and applicants. Contact NCDOT OCR for further assistance, if needed.
  6. For assistance with these Title VI requirements, contact the NCDOT Title VI Nondiscrimination Program at 1-800-522-0453.
- (b) Subrecipients (e.g. cities, counties, LGAs, planning organizations) may be required to prepare and submit a Title VI Plan to NCDOT, including Title VI Assurances and/or agreements. Subrecipients must also ensure compliance by their contractors and subrecipients with Title VI. (23 CFR 200.9(b)(7))
- (c) If reviewed or investigated by NCDOT, the contractor or subrecipient agrees to take affirmative action to correct any deficiencies found within a reasonable time period, not to exceed 90 calendar days, unless additional time is granted by NCDOT. (23 CFR 200.9(b)(15))
- (d) The Contractor is responsible for notifying subcontractors of NCDOT’s External Discrimination Complaints Process.
1. Applicability

Title VI and related laws protect participants and beneficiaries (e.g., members of the public and contractors) from discrimination by NCDOT employees, subrecipients and contractors, regardless of funding source.

## 2. Eligibility

Any person—or class of persons—who believes he/she has been subjected to discrimination based on race, color, national origin, Limited English Proficiency (LEP), sex, age, or disability (and religion in the context of employment, aviation, or transit) may file a written complaint. The law also prohibits intimidation or retaliation of any sort.

## 3. Time Limits and Filing Options

Complaints may be filed by the affected individual(s) or a representative and must be filed no later than 180 calendar days after the following:

- (i) The date of the alleged act of discrimination; or
- (ii) The date when the person(s) became aware of the alleged discrimination; or
- (iii) Where there has been a continuing course of conduct, the date on which that conduct was discontinued or the latest instance of the conduct.

Title VI and related discrimination complaints may be submitted to the following entities:

- North Carolina Department of Transportation, Office of Civil Rights, Title VI Program, 1511 Mail Service Center, Raleigh, NC 27699-1511; toll free 1-800-522-0453
- Federal Highway Administration, North Carolina Division Office, 310 New Bern Avenue, Suite 410, Raleigh, NC 27601, 919-747-7010
- US Department of Transportation, Departmental Office of Civil Rights, External Civil Rights Programs Division, 1200 New Jersey Avenue, SE, Washington, DC 20590; 202-366-4070

## 4. Format for Complaints

Complaints must be in writing and signed by the complainant(s) or a representative, and include the complainant's name, address, and telephone number. Complaints received by fax or e-mail will be acknowledged and processed. Allegations received by telephone will be reduced to writing and provided to the complainant for confirmation or revision before processing. Complaints will be accepted in other languages, including Braille.

## 5. Discrimination Complaint Form

Contact NCDOT Civil Rights to receive a full copy of the Discrimination Complaint Form and procedures.

## 6. Complaint Basis

Allegations must be based on issues involving race, color, national origin (LEP), sex, age, disability, or religion (in the context of employment, aviation or transit). "Basis" refers to the complainant's membership in a protected group category.

<b>TABLE 103-1 COMPLAINT BASIS</b>			
<b>Protected Categories</b>	<b>Definition</b>	<b>Examples</b>	<b>Applicable Nondiscrimination Authorities</b>
Race and Ethnicity	An individual belonging to one of the accepted racial groups; or the perception, based usually on physical characteristics that a person is a member of a racial group	Black/African American, Hispanic/Latino, Asian, American Indian/Alaska Native, Native Hawaiian/Pacific Islander, White	Title VI of the Civil Rights Act of 1964; 49 CFR Part 21; 23 CFR 200; 49 U.S.C. 5332(b); 49 U.S.C. 47123. ( <i>Executive Order 13166</i> )
Color	Color of skin, including shade of skin within a racial group	Black, White, brown, yellow, etc.	
National Origin ( <i>Limited English Proficiency</i> )	Place of birth. Citizenship is not a factor. ( <i>Discrimination based on language or a person's accent is also covered</i> )	Mexican, Cuban, Japanese, Vietnamese, Chinese	
Sex	Gender. The sex of an individual. <i>Note: Sex under this program does not include sexual orientation.</i>	Women and Men	1973 Federal-Aid Highway Act; 49 U.S.C. 5332(b); 49 U.S.C. 47123.
Age	Persons of any age	21-year-old person	Age Discrimination Act of 1975 49 U.S.C. 5332(b); 49 U.S.C. 47123.
Disability	Physical or mental impairment, permanent or temporary, or perceived.	Blind, alcoholic, para-amputee, epileptic, diabetic, arthritic	Section 504 of the Rehabilitation Act of 1973; Americans with Disabilities Act of 1990
Religion (in the context of employment) ( <i>Religion/ Creed in all aspects of any aviation or transit-related construction</i> )	An individual belonging to a religious group; or the perception, based on distinguishable characteristics that a person is a member of a religious group. In practice, actions taken as a result of the moral and ethical beliefs as to what is right and wrong, which are sincerely held with the strength of traditional religious views. <i>Note: Does not have to be associated with a recognized religious group or church; if an individual sincerely holds to the belief, it is a protected religious practice.</i>	Muslim, Christian, Sikh, Hindu, etc.	Title VII of the Civil Rights Act of 1964; 23 CFR 230; FHWA-1273 Required Contract Provisions. ( <i>49 U.S.C. 5332(b); 49 U.S.C. 47123</i> )

### (3) Pertinent Nondiscrimination Authorities

During the performance of this contract, the contractor, for itself, its assignees, and successors in interest agrees to comply with the following non-discrimination statutes and authorities, including, but not limited to:

- (a) Title VI of the Civil Rights Act of 1964 (42 U.S.C. § 2000d et seq., 78 stat. 252), (prohibits discrimination on the basis of race, color, national origin); and 49 CFR Part 21.

- (b) The Uniform Relocation Assistance and Real Property Acquisition Policies Act of 1970, (42 U.S.C. § 4601), (prohibits unfair treatment of persons displaced or whose property has been acquired because of Federal or Federal-aid programs and projects);
- (c) Federal-Aid Highway Act of 1973, (23 U.S.C. § 324 et seq.), (prohibits discrimination on the basis of sex);
- (d) Section 504 of the Rehabilitation Act of 1973, (29 U.S.C. § 794 et seq.), as amended, (prohibits discrimination on the basis of disability) and 49 CFR Part 27;
- (e) The Age Discrimination Act of 1975, as amended, (42 U.S.C. § 6101 et seq.), (prohibits discrimination on the basis of age);
- (f) Airport and Airway Improvement Act of 1982, (49 USC § 471, Section 47123), as amended, (prohibits discrimination based on race, creed, color, national origin, or sex);
- (g) The Civil Rights Restoration Act of 1987, (PL 100-209), (Broadened the scope, coverage and applicability of Title VI of the Civil Rights Act of 1964, The Age Discrimination Act of 1975 and Section 504 of the Rehabilitation Act of 1973, by expanding the definition of the terms "programs or activities" to include all of the programs or activities of the Federal-aid recipients, sub-recipients and contractors, whether such programs or activities are Federally funded or not);
- (h) Titles II and III of the Americans with Disabilities Act, which prohibit discrimination on the basis of disability in the operation of public entities, public and private transportation systems, places of public accommodation, and certain testing entities (42 U.S.C. §§ 12131-12189) as implemented by Department of Transportation regulations at 49 C.F.R. parts 37 and 38;
- (i) The Federal Aviation Administration's Nondiscrimination statute (49 U.S.C. § 47123) (prohibits discrimination on the basis of race, color, national origin, and sex);
- (j) Executive Order 12898, Federal Actions to Address Environmental Justice in Minority Populations and Low-Income Populations, which ensures Nondiscrimination against minority populations by discouraging programs, policies, and activities with disproportionately high and adverse human health or environmental effects on minority and low-income populations;
- (k) Executive Order 13166, Improving Access to Services for Persons with Limited English Proficiency, and resulting agency guidance, national origin discrimination includes discrimination because of Limited English proficiency (LEP). To ensure compliance with Title VI, you must take reasonable steps to ensure that LEP persons have meaningful access to your programs (70 Fed. Reg. at 74087 to 74100);
- (l) Title IX of the Education Amendments of 1972, as amended, which prohibits you from discriminating because of sex in education programs or activities (20 U.S.C. 1681 et seq).
- (m) Title VII of the Civil Rights Act of 1964 (42 U.S.C. § 2000e et seq., Pub. L. 88-352), (prohibits employment discrimination on the basis of race, color, religion, sex, or national origin).

**(4) Additional Title VI Assurances**

*\*\*The following Title VI Assurances (Appendices B, C and D) shall apply, as applicable*

- (a) Clauses for Deeds Transferring United States Property (1050.2A, Appendix B)



The following clauses will be included in deeds effecting or recording the transfer of real property, structures, or improvements thereon, or granting interest therein from the United States pursuant to the provisions of Assurance 4.

NOW, THEREFORE, the U.S. Department of Transportation as authorized by law and upon the condition that the North Carolina Department of Transportation (NCDOT) will accept title to the lands and maintain the project constructed thereon in accordance with the North Carolina General Assembly, the Regulations for the Administration of the Federal-Aid Highway Program, and the policies and procedures prescribed by the Federal Highway Administration of the U.S. Department of Transportation in accordance and in compliance with all requirements imposed by Title 49, Code of Federal Regulations, U.S. Department of Transportation, Subtitle A, Office of the Secretary, Part 21, Nondiscrimination in Federally-assisted programs of the U.S. Department of Transportation pertaining to and effectuating the provisions of Title VI of the Civil Rights Act of 1964 (78 Stat. 252; 42 U.S.C. § 2000d to 2000d-4), does hereby remise, release, quitclaim and convey unto the NCDOT all the right, title and interest of the U.S. Department of Transportation in and to said lands described in Exhibit A attached hereto and made a part hereof.

(HABENDUM CLAUSE)

TO HAVE AND TO HOLD said lands and interests therein unto the North Carolina Department of Transportation (NCDOT) and its successors forever, subject, however, to the covenants, conditions, restrictions and reservations herein contained as follows, which will remain in effect for the period during which the real property or structures are used for a purpose for which Federal financial assistance is extended or for another purpose involving the provision of similar services or benefits and will be binding on the NCDOT, its successors and assigns.

The NCDOT, in consideration of the conveyance of said lands and interests in lands, does hereby covenant and agree as a covenant running with the land for itself, its successors and assigns, that (1) no person will on the grounds of race, color, or national origin, be excluded from participation in, be denied the benefits of, or be otherwise subjected to discrimination with regard to any facility located wholly or in part on, over, or under such lands hereby conveyed [,] [and]\* (2) that the NCDOT will use the lands and interests in lands and interests in lands so conveyed, in compliance with all requirements imposed by or pursuant to Title 49, Code of Federal Regulations, U.S. Department of Transportation, Subtitle A, Office of the Secretary, Part 21, Nondiscrimination in Federally-assisted programs of the U.S. Department of Transportation, Effectuation of Title VI of the Civil Rights Act of 1964, and as said Regulations and Acts may be amended [, and (3) that in the event of breach of any of the above-mentioned nondiscrimination conditions, the Department will have a right to enter or re-enter said lands and facilities on said land, and that above described land and facilities will thereon revert to and vest in and become the absolute property of the U.S. Department of Transportation and its assigns as such interest existed prior to this instruction].\*

(\*Reverter clause and related language to be used only when it is determined that such a clause is necessary in order to make clear the purpose of Title VI.)

(b) Clauses for Transfer of Real Property Acquired or Improved Under the Activity, Facility, or Program (1050.2A, Appendix C)

The following clauses will be included in deeds, licenses, leases, permits, or similar instruments entered into by the North Carolina Department of Transportation (NCDOT) pursuant to the provisions of Assurance 7(a):

1. The (grantee, lessee, permittee, etc. as appropriate) for himself/herself, his/her heirs, personal representatives, successors in interest, and assigns, as a part of the consideration hereof, does hereby covenant and agree [in the case of deeds and leases add "as a covenant running with the land"] that:
  - (i.) In the event facilities are constructed, maintained, or otherwise operated on the property described in this (deed, license, lease, permit, etc.) for a purpose for which a U.S. Department of Transportation activity, facility, or program is extended or for another purpose involving the provision of similar services or benefits, the (grantee, licensee, lessee, permittee, etc.) will maintain and operate such facilities and services in compliance with all requirements imposed by the Acts and Regulations (as may be amended) such that no person on the grounds of race, color, or national origin, will be excluded from participation in, denied the benefits of, or be otherwise subjected to discrimination in the use of said facilities.
2. With respect to licenses, leases, permits, etc., in the event of breach of any of the above Nondiscrimination covenants, the NCDOT will have the right to terminate the (lease, license, permit, etc.) and to enter, re-enter, and repossess said lands and facilities thereon, and hold the same as if the (lease, license, permit, etc.) had never been made or issued. \*
3. With respect to a deed, in the event of breach of any of the above Nondiscrimination covenants, the NCDOT will have the right to enter or re-enter the lands and facilities thereon, and the above described lands and facilities will there upon revert to and vest in and become the absolute property of the NCDOT and its assigns. \*

(\*Reverter clause and related language to be used only when it is determined that such a clause is necessary to make clear the purpose of Title VI.)

(c) Clauses for Construction/Use/Access to Real Property Acquired Under the Activity, Facility or Program (1050.2A, Appendix D)

The following clauses will be included in deeds, licenses, permits, or similar instruments/ agreements entered into by the North Carolina Department of Transportation (NCDOT) pursuant to the provisions of Assurance 7(b):

1. The (grantee, licensee, permittee, etc., as appropriate) for himself/herself, his/her heirs, personal representatives, successors in interest, and assigns, as a part of the consideration hereof, does hereby covenant and agree (in the case of deeds and leases add, "as a covenant running with the land") that (1) no person on the ground of race, color, or national origin, will be excluded from participation in, denied the benefits of, or be otherwise subjected to discrimination in the use of said facilities, (2) that in the construction of any improvements on, over, or under such land, and the furnishing of services thereon, no person on the ground of race, color, or national origin, will be excluded from participation in, denied the benefits of, or otherwise be subjected to discrimination, (3) that the (grantee, licensee, lessee, permittee, etc.) will use the premises in compliance with all other requirements imposed by or pursuant to the Acts and Regulations, as amended, set forth in this Assurance.
2. With respect to (licenses, leases, permits, etc.), in the event of breach of any of the above Non-discrimination covenants, the NCDOT will have the right to terminate the (license, permit, etc., as appropriate) and to enter or re-enter and repossess said land and the facilities thereon, and hold the same as if said (license, permit, etc., as appropriate) had never been made or issued. \*
3. With respect to deeds, in the event of breach of any of the above Nondiscrimination covenants, the NCDOT will there upon revert to and vest in and become the absolute property of the NCDOT and its assigns. \*

(\*Reverter clause and related language to be used only when it is determined that such a clause is necessary to make clear the purpose of Title VI.)

**STANDARD SPECIAL PROVISION****MINORITY AND FEMALE EMPLOYMENT REQUIREMENTS**

Z-7

NOTICE OF REQUIREMENTS FOR AFFIRMATIVE ACTION TO ENSURE EQUAL EMPLOYMENT OPPORTUNITY (*EXECUTIVE NUMBER 11246*)

1. The goals and timetables for minority and female participation, expressed in percentage terms for the Contractor's aggregate workforce in each trade on all construction work in the covered area, see as shown on the attached sheet entitled "Employment Goals for Minority and Female participation".

These goals are applicable to all the Contractor's construction work (whether or not it is Federal or federally assisted) performed in the covered area. If the Contractor performs construction work in a geographical area located outside of the covered area, it shall apply the goals established for such geographical area where the work is actually performed. With regard to this second area, the Contractor also is subject to the goals for both its federally involved and nonfederally involved construction.

The Contractor's compliance with the Executive Order and the regulations in *41 CFR Part 60-4* shall be based on its implementation of the Equal Opportunity Clause, specific affirmative action obligations required by the specifications set forth in *41 CFR 60-4.3(a)*, and its effort to meet the goals. The hours of minority and female employment and training must be substantially uniform throughout the length of the contract, and in each trade and the Contractor shall make a good faith effort to employ minorities and women evenly on each of its projects. The transfer of minority or female employees or trainees from Contractor to Contractor or from project to project for the sole purpose of meeting the Contractor's goals shall be a violation of the contract, the executive Order and the regulations in *41 CFR Part 60-4*. Compliance with the goals will be measured against the total work hours performed.

2. As used in this Notice and in the contract resulting from this solicitation, the "covered area" is the county or counties shown on the cover sheet of the proposal form and contract.

**EMPLOYMENT GOALS FOR MINORITY  
AND FEMALE PARTICIPATION**

Economic Areas

**Area 023 29.7%**

Bertie County  
Camden County  
Chowan County  
Gates County  
Hertford County  
Pasquotank County  
Perquimans County

**Area 024 31.7%**

Beaufort County  
Carteret County  
Craven County  
Dare County  
Edgecombe County  
Green County  
Halifax County  
Hyde County  
Jones County  
Lenoir County  
Martin County  
Nash County  
Northampton County  
Pamlico County  
Pitt County  
Tyrrell County  
Washington County  
Wayne County  
Wilson County

**Area 025 23.5%**

Columbus County  
Duplin County  
Onslow County  
Pender County

**Area 026 33.5%**

Bladen County  
Hoke County  
Richmond County  
Robeson County  
Sampson County  
Scotland County

**Area 027 24.7%**

Chatham County  
Franklin County  
Granville County  
Harnett County  
Johnston County  
Lee County  
Person County  
Vance County  
Warren County

**Area 028 15.5%**

Alleghany County  
Ashe County  
Caswell County  
Davie County  
Montgomery County  
Moore County  
Rockingham County  
Surry County  
Watauga County  
Wilkes County

**Area 029 15.7%**

Alexander County  
Anson County  
Burke County  
Cabarrus County  
Caldwell County  
Catawba County  
Cleveland County  
Iredell County  
Lincoln County  
Polk County  
Rowan County  
Rutherford County  
Stanly County

**Area 0480 8.5%**

Buncombe County  
Madison County

**Area 030 6.3%**

Avery County  
Cherokee County  
Clay County  
Graham County  
Haywood County  
Henderson County  
Jackson County  
McDowell County  
Macon County  
Mitchell County  
Swain County  
Transylvania County  
Yancey County

SMSA Areas

Area 5720 26.6%

Currituck County

Area 9200 20.7%

Brunswick County

New Hanover County

Area 2560 24.2%

Cumberland County

Area 6640 22.8%

Durham County

Orange County

Wake County

Area 1300 16.2%

Alamance County

Area 3120 16.4%

Davidson County

Forsyth County

Guilford County

Randolph County

Stokes County

Yadkin County

Area 1520 18.3%

Gaston County

Mecklenburg County

Union County

---

Goals for Female

Participation in Each Trade

(Statewide) 6.9%

FHWA-1273 -- Revised October 23, 2023

## REQUIRED CONTRACT PROVISIONS FEDERAL-AID CONSTRUCTION CONTRACTS

- I. General
- II. Nondiscrimination
- III. Non-segregated Facilities
- IV. Davis-Bacon and Related Act Provisions
- V. Contract Work Hours and Safety Standards Act Provisions
- VI. Subletting or Assigning the Contract
- VII. Safety: Accident Prevention
- VIII. False Statements Concerning Highway Projects
- IX. Implementation of Clean Air Act and Federal Water Pollution Control Act
- X. Certification Regarding Debarment, Suspension, Ineligibility and Voluntary Exclusion
- XI. Certification Regarding Use of Contract Funds for Lobbying
- XII. Use of United States-Flag Vessels:

## ATTACHMENTS

A. Employment and Materials Preference for Appalachian Development Highway System or Appalachian Local Access Road Contracts (included in Appalachian contracts only)

**I. GENERAL**

1. Form FHWA-1273 must be physically incorporated in each construction contract funded under title 23, United States Code, as required in 23 CFR 633.102(b) (excluding emergency contracts solely intended for debris removal). The contractor (or subcontractor) must insert this form in each subcontract and further require its inclusion in all lower tier subcontracts (excluding purchase orders, rental agreements and other agreements for supplies or services). 23 CFR 633.102(e).

The applicable requirements of Form FHWA-1273 are incorporated by reference for work done under any purchase order, rental agreement or agreement for other services. The prime contractor shall be responsible for compliance by any subcontractor, lower-tier subcontractor or service provider. 23 CFR 633.102(e).

Form FHWA-1273 must be included in all Federal-aid design-build contracts, in all subcontracts and in lower tier subcontracts (excluding subcontracts for design services, purchase orders, rental agreements and other agreements for supplies or services) in accordance with 23 CFR 633.102. The design-builder shall be responsible for compliance by any subcontractor, lower-tier subcontractor or service provider.

Contracting agencies may reference Form FHWA-1273 in solicitation-for-bids or request-for-proposals documents, however, the Form FHWA-1273 must be physically incorporated (not referenced) in all contracts, subcontracts and lower-tier subcontracts (excluding purchase orders, rental agreements and other agreements for supplies or services related to a construction contract). 23 CFR 633.102(b).

2. Subject to the applicability criteria noted in the following sections, these contract provisions shall apply to all work

performed on the contract by the contractor's own organization and with the assistance of workers under the contractor's immediate superintendence and to all work performed on the contract by piecework, station work, or by subcontract. 23 CFR 633.102(d).

3. A breach of any of the stipulations contained in these Required Contract Provisions may be sufficient grounds for withholding of progress payments, withholding of final payment, termination of the contract, suspension / debarment or any other action determined to be appropriate by the contracting agency and FHWA.

4. Selection of Labor: During the performance of this contract, the contractor shall not use convict labor for any purpose within the limits of a construction project on a Federal-aid highway unless it is labor performed by convicts who are on parole, supervised release, or probation. 23 U.S.C. 114(b). The term Federal-aid highway does not include roadways functionally classified as local roads or rural minor collectors. 23 U.S.C. 101(a).

**II. NONDISCRIMINATION** (23 CFR 230.107(a); 23 CFR Part 230, Subpart A, Appendix A; EO 11246)

The provisions of this section related to 23 CFR Part 230, Subpart A, Appendix A are applicable to all Federal-aid construction contracts and to all related construction subcontracts of \$10,000 or more. The provisions of 23 CFR Part 230 are not applicable to material supply, engineering, or architectural service contracts.

In addition, the contractor and all subcontractors must comply with the following policies: Executive Order 11246, 41 CFR Part 60, 29 CFR Parts 1625-1627, 23 U.S.C. 140, Section 504 of the Rehabilitation Act of 1973, as amended (29 U.S.C. 794), Title VI of the Civil Rights Act of 1964, as amended (42 U.S.C. 2000d et seq.), and related regulations including 49 CFR Parts 21, 26, and 27; and 23 CFR Parts 200, 230, and 633.

The contractor and all subcontractors must comply with: the requirements of the Equal Opportunity Clause in 41 CFR 60-1.4(b) and, for all construction contracts exceeding \$10,000, the Standard Federal Equal Employment Opportunity Construction Contract Specifications in 41 CFR 60-4.3.

Note: The U.S. Department of Labor has exclusive authority to determine compliance with Executive Order 11246 and the policies of the Secretary of Labor including 41 CFR Part 60, and 29 CFR Parts 1625-1627. The contracting agency and the FHWA have the authority and the responsibility to ensure compliance with 23 U.S.C. 140, Section 504 of the Rehabilitation Act of 1973, as amended (29 U.S.C. 794), and Title VI of the Civil Rights Act of 1964, as amended (42 U.S.C. 2000d et seq.), and related regulations including 49 CFR Parts 21, 26, and 27; and 23 CFR Parts 200, 230, and 633.

The following provision is adopted from 23 CFR Part 230, Subpart A, Appendix A, with appropriate revisions to conform to the U.S. Department of Labor (US DOL) and FHWA requirements.

**1. Equal Employment Opportunity:** Equal Employment Opportunity (EEO) requirements not to discriminate and to take affirmative action to assure equal opportunity as set forth under laws, executive orders, rules, regulations (see 28 CFR Part 35, 29 CFR Part 1630, 29 CFR Parts 1625-1627, 41 CFR Part 60 and 49 CFR Part 27) and orders of the Secretary of Labor as modified by the provisions prescribed herein, and imposed pursuant to 23 U.S.C. 140, shall constitute the EEO and specific affirmative action standards for the contractor's project activities under this contract. The provisions of the Americans with Disabilities Act of 1990 (42 U.S.C. 12101 et seq.) set forth under 28 CFR Part 35 and 29 CFR Part 1630 are incorporated by reference in this contract. In the execution of this contract, the contractor agrees to comply with the following minimum specific requirement activities of EEO:

a. The contractor will work with the contracting agency and the Federal Government to ensure that it has made every good faith effort to provide equal opportunity with respect to all of its terms and conditions of employment and in their review of activities under the contract. 23 CFR 230.409 (g)(4) & (5).

b. The contractor will accept as its operating policy the following statement:

"It is the policy of this Company to assure that applicants are employed, and that employees are treated during employment, without regard to their race, religion, sex, sexual orientation, gender identity, color, national origin, age or disability. Such action shall include: employment, upgrading, demotion, or transfer; recruitment or recruitment advertising; layoff or termination; rates of pay or other forms of compensation; and selection for training, including apprenticeship, pre-apprenticeship, and/or on-the-job training."

**2. EEO Officer:** The contractor will designate and make known to the contracting officers an EEO Officer who will have the responsibility for and must be capable of effectively administering and promoting an active EEO program and who must be assigned adequate authority and responsibility to do so.

**3. Dissemination of Policy:** All members of the contractor's staff who are authorized to hire, supervise, promote, and discharge employees, or who recommend such action or are substantially involved in such action, will be made fully cognizant of and will implement the contractor's EEO policy and contractual responsibilities to provide EEO in each grade and classification of employment. To ensure that the above agreement will be met, the following actions will be taken as a minimum:

a. Periodic meetings of supervisory and personnel office employees will be conducted before the start of work and then not less often than once every six months, at which time the contractor's EEO policy and its implementation will be reviewed and explained. The meetings will be conducted by the EEO Officer or other knowledgeable company official.

b. All new supervisory or personnel office employees will be given a thorough indoctrination by the EEO Officer, covering all major aspects of the contractor's EEO obligations within thirty days following their reporting for duty with the contractor.

c. All personnel who are engaged in direct recruitment for the project will be instructed by the EEO Officer in the contractor's procedures for locating and hiring minorities and women.

d. Notices and posters setting forth the contractor's EEO policy will be placed in areas readily accessible to employees, applicants for employment and potential employees.

e. The contractor's EEO policy and the procedures to implement such policy will be brought to the attention of employees by means of meetings, employee handbooks, or other appropriate means.

**4. Recruitment:** When advertising for employees, the contractor will include in all advertisements for employees the notation: "An Equal Opportunity Employer." All such advertisements will be placed in publications having a large circulation among minorities and women in the area from which the project work force would normally be derived.

a. The contractor will, unless precluded by a valid bargaining agreement, conduct systematic and direct recruitment through public and private employee referral sources likely to yield qualified minorities and women. To meet this requirement, the contractor will identify sources of potential minority group employees and establish with such identified sources procedures whereby minority and women applicants may be referred to the contractor for employment consideration.

b. In the event the contractor has a valid bargaining agreement providing for exclusive hiring hall referrals, the contractor is expected to observe the provisions of that agreement to the extent that the system meets the contractor's compliance with EEO contract provisions. Where implementation of such an agreement has the effect of discriminating against minorities or women, or obligates the contractor to do the same, such implementation violates Federal nondiscrimination provisions.

c. The contractor will encourage its present employees to refer minorities and women as applicants for employment. Information and procedures with regard to referring such applicants will be discussed with employees.

**5. Personnel Actions:** Wages, working conditions, and employee benefits shall be established and administered, and personnel actions of every type, including hiring, upgrading, promotion, transfer, demotion, layoff, and termination, shall be taken without regard to race, color, religion, sex, sexual orientation, gender identity, national origin, age or disability. The following procedures shall be followed:

a. The contractor will conduct periodic inspections of project sites to ensure that working conditions and employee facilities do not indicate discriminatory treatment of project site personnel.

b. The contractor will periodically evaluate the spread of wages paid within each classification to determine any evidence of discriminatory wage practices.

c. The contractor will periodically review selected personnel actions in depth to determine whether there is evidence of discrimination. Where evidence is found, the contractor will promptly take corrective action. If the review indicates that the discrimination may extend beyond the actions reviewed, such corrective action shall include all affected persons.

d. The contractor will promptly investigate all complaints of alleged discrimination made to the contractor in connection with its obligations under this contract, will attempt to resolve such complaints, and will take appropriate corrective action



within a reasonable time. If the investigation indicates that the discrimination may affect persons other than the complainant, such corrective action shall include such other persons. Upon completion of each investigation, the contractor will inform every complainant of all of their avenues of appeal.

#### 6. Training and Promotion:

a. The contractor will assist in locating, qualifying, and increasing the skills of minorities and women who are applicants for employment or current employees. Such efforts should be aimed at developing full journey level status employees in the type of trade or job classification involved.

b. Consistent with the contractor's work force requirements and as permissible under Federal and State regulations, the contractor shall make full use of training programs (i.e., apprenticeship and on-the-job training programs for the geographical area of contract performance). In the event a special provision for training is provided under this contract, this subparagraph will be superseded as indicated in the special provision. The contracting agency may reserve training positions for persons who receive welfare assistance in accordance with 23 U.S.C. 140(a).

c. The contractor will advise employees and applicants for employment of available training programs and entrance requirements for each.

d. The contractor will periodically review the training and promotion potential of employees who are minorities and women and will encourage eligible employees to apply for such training and promotion.

**7. Unions:** If the contractor relies in whole or in part upon unions as a source of employees, the contractor will use good faith efforts to obtain the cooperation of such unions to increase opportunities for minorities and women. 23 CFR 230.409. Actions by the contractor, either directly or through a contractor's association acting as agent, will include the procedures set forth below:

a. The contractor will use good faith efforts to develop, in cooperation with the unions, joint training programs aimed toward qualifying more minorities and women for membership in the unions and increasing the skills of minorities and women so that they may qualify for higher paying employment.

b. The contractor will use good faith efforts to incorporate an EEO clause into each union agreement to the end that such union will be contractually bound to refer applicants without regard to their race, color, religion, sex, sexual orientation, gender identity, national origin, age, or disability.

c. The contractor is to obtain information as to the referral practices and policies of the labor union except that to the extent such information is within the exclusive possession of the labor union and such labor union refuses to furnish such information to the contractor, the contractor shall so certify to the contracting agency and shall set forth what efforts have been made to obtain such information.

d. In the event the union is unable to provide the contractor with a reasonable flow of referrals within the time limit set forth in the collective bargaining agreement, the contractor will, through independent recruitment efforts, fill the employment vacancies without regard to race, color, religion, sex, sexual orientation, gender identity, national origin, age, or disability; making full efforts to obtain qualified and/or qualifiable minorities and women. The failure of a union to provide

sufficient referrals (even though it is obligated to provide exclusive referrals under the terms of a collective bargaining agreement) does not relieve the contractor from the requirements of this paragraph. In the event the union referral practice prevents the contractor from meeting the obligations pursuant to Executive Order 11246, as amended, and these special provisions, such contractor shall immediately notify the contracting agency.

**8. Reasonable Accommodation for Applicants / Employees with Disabilities:** The contractor must be familiar with the requirements for and comply with the Americans with Disabilities Act and all rules and regulations established thereunder. Employers must provide reasonable accommodation in all employment activities unless to do so would cause an undue hardship.

**9. Selection of Subcontractors, Procurement of Materials and Leasing of Equipment:** The contractor shall not discriminate on the grounds of race, color, religion, sex, sexual orientation, gender identity, national origin, age, or disability in the selection and retention of subcontractors, including procurement of materials and leases of equipment. The contractor shall take all necessary and reasonable steps to ensure nondiscrimination in the administration of this contract.

a. The contractor shall notify all potential subcontractors, suppliers, and lessors of their EEO obligations under this contract.

b. The contractor will use good faith efforts to ensure subcontractor compliance with their EEO obligations.

#### 10. Assurances Required:

a. The requirements of 49 CFR Part 26 and the State DOT's FHWA-approved Disadvantaged Business Enterprise (DBE) program are incorporated by reference.

b. The contractor, subrecipient or subcontractor shall not discriminate on the basis of race, color, national origin, or sex in the performance of this contract. The contractor shall carry out applicable requirements of 49 CFR part 26 in the award and administration of DOT-assisted contracts. Failure by the contractor to carry out these requirements is a material breach of this contract, which may result in the termination of this contract or such other remedy as the recipient deems appropriate, which may include, but is not limited to:

- (1) Withholding monthly progress payments;
- (2) Assessing sanctions;
- (3) Liquidated damages; and/or
- (4) Disqualifying the contractor from future bidding as non-responsible.

c. The Title VI and nondiscrimination provisions of U.S. DOT Order 1050.2A at Appendixes A and E are incorporated by reference. 49 CFR Part 21.

**11. Records and Reports:** The contractor shall keep such records as necessary to document compliance with the EEO requirements. Such records shall be retained for a period of three years following the date of the final payment to the contractor for all contract work and shall be available at reasonable times and places for inspection by authorized representatives of the contracting agency and the FHWA.

a. The records kept by the contractor shall document the following:

(1) The number and work hours of minority and non-minority group members and women employed in each work classification on the project;

(2) The progress and efforts being made in cooperation with unions, when applicable, to increase employment opportunities for minorities and women; and

(3) The progress and efforts being made in locating, hiring, training, qualifying, and upgrading minorities and women.

b. The contractors and subcontractors will submit an annual report to the contracting agency each July for the duration of the project indicating the number of minority, women, and non-minority group employees currently engaged in each work classification required by the contract work. This information is to be reported on [Form FHWA-1391](#). The staffing data should represent the project work force on board in all or any part of the last payroll period preceding the end of July. If on-the-job training is being required by special provision, the contractor will be required to collect and report training data. The employment data should reflect the work force on board during all or any part of the last payroll period preceding the end of July.

### III. NONSEGREGATED FACILITIES

This provision is applicable to all Federal-aid construction contracts and to all related construction subcontracts of more than \$10,000. 41 CFR 60-1.5.

As prescribed by 41 CFR 60-1.8, the contractor must ensure that facilities provided for employees are provided in such a manner that segregation on the basis of race, color, religion, sex, sexual orientation, gender identity, or national origin cannot result. The contractor may neither require such segregated use by written or oral policies nor tolerate such use by employee custom. The contractor's obligation extends further to ensure that its employees are not assigned to perform their services at any location under the contractor's control where the facilities are segregated. The term "facilities" includes waiting rooms, work areas, restaurants and other eating areas, time clocks, restrooms, washrooms, locker rooms and other storage or dressing areas, parking lots, drinking fountains, recreation or entertainment areas, transportation, and housing provided for employees. The contractor shall provide separate or single-user restrooms and necessary dressing or sleeping areas to assure privacy between sexes.

### IV. DAVIS-BACON AND RELATED ACT PROVISIONS

This section is applicable to all Federal-aid construction projects exceeding \$2,000 and to all related subcontracts and lower-tier subcontracts (regardless of subcontract size), in accordance with 29 CFR 5.5. The requirements apply to all projects located within the right-of-way of a roadway that is functionally classified as Federal-aid highway. 23 U.S.C. 113. This excludes roadways functionally classified as local roads or rural minor collectors, which are exempt. 23 U.S.C. 101. Where applicable law requires that projects be treated as a project on a Federal-aid highway, the provisions of this subpart will apply regardless of the location of the project. Examples include: Surface Transportation Block Grant Program projects funded under 23 U.S.C. 133 [excluding recreational trails projects], the Nationally Significant Freight and Highway

Projects funded under 23 U.S.C. 117, and National Highway Freight Program projects funded under 23 U.S.C. 167.

The following provisions are from the U.S. Department of Labor regulations in 29 CFR 5.5 "Contract provisions and related matters" with minor revisions to conform to the FHWA-1273 format and FHWA program requirements.

#### 1. Minimum wages (29 CFR 5.5)

a. *Wage rates and fringe benefits.* All laborers and mechanics employed or working upon the site of the work (or otherwise working in construction or development of the project under a development statute), will be paid unconditionally and not less often than once a week, and without subsequent deduction or rebate on any account (except such payroll deductions as are permitted by regulations issued by the Secretary of Labor under the Copeland Act ([29 CFR part 3](#))), the full amount of basic hourly wages and bona fide fringe benefits (or cash equivalents thereof) due at time of payment computed at rates not less than those contained in the wage determination of the Secretary of Labor which is attached hereto and made a part hereof, regardless of any contractual relationship which may be alleged to exist between the contractor and such laborers and mechanics. As provided in paragraphs (d) and (e) of 29 CFR 5.5, the appropriate wage determinations are effective by operation of law even if they have not been attached to the contract. Contributions made or costs reasonably anticipated for bona fide fringe benefits under the Davis-Bacon Act ([40 U.S.C. 3141\(2\)\(B\)](#)) on behalf of laborers or mechanics are considered wages paid to such laborers or mechanics, subject to the provisions of paragraph 1.e. of this section; also, regular contributions made or costs incurred for more than a weekly period (but not less often than quarterly) under plans, funds, or programs which cover the particular weekly period, are deemed to be constructively made or incurred during such weekly period. Such laborers and mechanics must be paid the appropriate wage rate and fringe benefits on the wage determination for the classification(s) of work actually performed, without regard to skill, except as provided in paragraph 4. of this section. Laborers or mechanics performing work in more than one classification may be compensated at the rate specified for each classification for the time actually worked therein: *Provided*, That the employer's payroll records accurately set forth the time spent in each classification in which work is performed. The wage determination (including any additional classifications and wage rates conformed under paragraph 1.c. of this section) and the Davis-Bacon poster (WH-1321) must be posted at all times by the contractor and its subcontractors at the site of the work in a prominent and accessible place where it can be easily seen by the workers.

b. *Frequently recurring classifications.* (1) In addition to wage and fringe benefit rates that have been determined to be prevailing under the procedures set forth in [29 CFR part 1](#), a wage determination may contain, pursuant to § 1.3(f), wage and fringe benefit rates for classifications of laborers and mechanics for which conformance requests are regularly submitted pursuant to paragraph 1.c. of this section, provided that:

(i) The work performed by the classification is not performed by a classification in the wage determination for which a prevailing wage rate has been determined;

(ii) The classification is used in the area by the construction industry; and

(iii) The wage rate for the classification bears a reasonable relationship to the prevailing wage rates contained in the wage determination.

(2) The Administrator will establish wage rates for such classifications in accordance with paragraph 1.c.(1)(iii) of this section. Work performed in such a classification must be paid at no less than the wage and fringe benefit rate listed on the wage determination for such classification.

c. *Conformance.* (1) The contracting officer must require that any class of laborers or mechanics, including helpers, which is not listed in the wage determination and which is to be employed under the contract be classified in conformance with the wage determination. Conformance of an additional classification and wage rate and fringe benefits is appropriate only when the following criteria have been met:

(i) The work to be performed by the classification requested is not performed by a classification in the wage determination; and

(ii) The classification is used in the area by the construction industry; and

(iii) The proposed wage rate, including any bona fide fringe benefits, bears a reasonable relationship to the wage rates contained in the wage determination.

(2) The conformance process may not be used to split, subdivide, or otherwise avoid application of classifications listed in the wage determination.

(3) If the contractor and the laborers and mechanics to be employed in the classification (if known), or their representatives, and the contracting officer agree on the classification and wage rate (including the amount designated for fringe benefits where appropriate), a report of the action taken will be sent by the contracting officer by email to [DBAconformance@dol.gov](mailto:DBAconformance@dol.gov). The Administrator, or an authorized representative, will approve, modify, or disapprove every additional classification action within 30 days of receipt and so advise the contracting officer or will notify the contracting officer within the 30-day period that additional time is necessary.

(4) In the event the contractor, the laborers or mechanics to be employed in the classification or their representatives, and the contracting officer do not agree on the proposed classification and wage rate (including the amount designated for fringe benefits, where appropriate), the contracting officer will, by email to [DBAconformance@dol.gov](mailto:DBAconformance@dol.gov), refer the questions, including the views of all interested parties and the recommendation of the contracting officer, to the Administrator for determination. The Administrator, or an authorized representative, will issue a determination within 30 days of receipt and so advise the contracting officer or will notify the contracting officer within the 30-day period that additional time is necessary.

(5) The contracting officer must promptly notify the contractor of the action taken by the Wage and Hour Division

under paragraphs 1.c.(3) and (4) of this section. The contractor must furnish a written copy of such determination to each affected worker or it must be posted as a part of the wage determination. The wage rate (including fringe benefits where appropriate) determined pursuant to paragraph 1.c.(3) or (4) of this section must be paid to all workers performing work in the classification under this contract from the first day on which work is performed in the classification.

d. *Fringe benefits not expressed as an hourly rate.* Whenever the minimum wage rate prescribed in the contract for a class of laborers or mechanics includes a fringe benefit which is not expressed as an hourly rate, the contractor may either pay the benefit as stated in the wage determination or may pay another bona fide fringe benefit or an hourly cash equivalent thereof.

e. *Unfunded plans.* If the contractor does not make payments to a trustee or other third person, the contractor may consider as part of the wages of any laborer or mechanic the amount of any costs reasonably anticipated in providing bona fide fringe benefits under a plan or program, *Provided*, That the Secretary of Labor has found, upon the written request of the contractor, in accordance with the criteria set forth in § 5.28, that the applicable standards of the Davis-Bacon Act have been met. The Secretary of Labor may require the contractor to set aside in a separate account assets for the meeting of obligations under the plan or program.

f. *Interest.* In the event of a failure to pay all or part of the wages required by the contract, the contractor will be required to pay interest on any underpayment of wages.

## 2. Withholding (29 CFR 5.5)

a. *Withholding requirements.* The contracting agency may, upon its own action, or must, upon written request of an authorized representative of the Department of Labor, withhold or cause to be withheld from the contractor so much of the accrued payments or advances as may be considered necessary to satisfy the liabilities of the prime contractor or any subcontractor for the full amount of wages and monetary relief, including interest, required by the clauses set forth in this section for violations of this contract, or to satisfy any such liabilities required by any other Federal contract, or federally assisted contract subject to Davis-Bacon labor standards, that is held by the same prime contractor (as defined in § 5.2). The necessary funds may be withheld from the contractor under this contract, any other Federal contract with the same prime contractor, or any other federally assisted contract that is subject to Davis-Bacon labor standards requirements and is held by the same prime contractor, regardless of whether the other contract was awarded or assisted by the same agency, and such funds may be used to satisfy the contractor liability for which the funds were withheld. In the event of a contractor's failure to pay any laborer or mechanic, including any apprentice or helper working on the site of the work all or part of the wages required by the contract, or upon the contractor's failure to submit the required records as discussed in paragraph 3.d. of this section, the contracting agency may on its own initiative and after written notice to the contractor, take such action as may be necessary to cause the suspension of any further payment, advance, or guarantee of funds until such violations have ceased.

b. *Priority to withheld funds.* The Department has priority to funds withheld or to be withheld in accordance with paragraph

2.a. of this section or Section V, paragraph 3.a., or both, over claims to those funds by:

- (1) A contractor's surety(ies), including without limitation performance bond sureties and payment bond sureties;
- (2) A contracting agency for its procurement costs;
- (3) A trustee(s) (either a court-appointed trustee or a U.S. trustee, or both) in bankruptcy of a contractor, or a contractor's bankruptcy estate;
- (4) A contractor's assignee(s);
- (5) A contractor's successor(s); or
- (6) A claim asserted under the Prompt Payment Act, [31 U.S.C. 3901](#)–3907.

### 3. Records and certified payrolls (29 CFR 5.5)

a. *Basic record requirements* (1) *Length of record retention.* All regular payrolls and other basic records must be maintained by the contractor and any subcontractor during the course of the work and preserved for all laborers and mechanics working at the site of the work (or otherwise working in construction or development of the project under a development statute) for a period of at least 3 years after all the work on the prime contract is completed.

(2) *Information required.* Such records must contain the name; Social Security number; last known address, telephone number, and email address of each such worker; each worker's correct classification(s) of work actually performed; hourly rates of wages paid (including rates of contributions or costs anticipated for bona fide fringe benefits or cash equivalents thereof of the types described in [40 U.S.C. 3141\(2\)\(B\)](#) of the Davis-Bacon Act); daily and weekly number of hours actually worked in total and on each covered contract; deductions made; and actual wages paid.

(3) *Additional records relating to fringe benefits.* Whenever the Secretary of Labor has found under paragraph 1.e. of this section that the wages of any laborer or mechanic include the amount of any costs reasonably anticipated in providing benefits under a plan or program described in [40 U.S.C. 3141\(2\)\(B\)](#) of the Davis-Bacon Act, the contractor must maintain records which show that the commitment to provide such benefits is enforceable, that the plan or program is financially responsible, and that the plan or program has been communicated in writing to the laborers or mechanics affected, and records which show the costs anticipated or the actual cost incurred in providing such benefits.

(4) *Additional records relating to apprenticeship.* Contractors with apprentices working under approved programs must maintain written evidence of the registration of apprenticeship programs, the registration of the apprentices, and the ratios and wage rates prescribed in the applicable programs.

b. *Certified payroll requirements* (1) *Frequency and method of submission.* The contractor or subcontractor must submit weekly, for each week in which any DBA- or Related Acts-covered work is performed, certified payrolls to the contracting

agency. The prime contractor is responsible for the submission of all certified payrolls by all subcontractors. A contracting agency or prime contractor may permit or require contractors to submit certified payrolls through an electronic system, as long as the electronic system requires a legally valid electronic signature; the system allows the contractor, the contracting agency, and the Department of Labor to access the certified payrolls upon request for at least 3 years after the work on the prime contract has been completed; and the contracting agency or prime contractor permits other methods of submission in situations where the contractor is unable or limited in its ability to use or access the electronic system.

(2) *Information required.* The certified payrolls submitted must set out accurately and completely all of the information required to be maintained under paragraph 3.a.(2) of this section, except that full Social Security numbers and last known addresses, telephone numbers, and email addresses must not be included on weekly transmittals. Instead, the certified payrolls need only include an individually identifying number for each worker ( e.g., the last four digits of the worker's Social Security number). The required weekly certified payroll information may be submitted using Optional Form WH-347 or in any other format desired. Optional Form WH-347 is available for this purpose from the Wage and Hour Division website at <https://www.dol.gov/sites/dolgov/files/WHD/legacy/files/wh347.pdf> or its successor website. It is not a violation of this section for a prime contractor to require a subcontractor to provide full Social Security numbers and last known addresses, telephone numbers, and email addresses to the prime contractor for its own records, without weekly submission by the subcontractor to the contracting agency.

(3) *Statement of Compliance.* Each certified payroll submitted must be accompanied by a "Statement of Compliance," signed by the contractor or subcontractor, or the contractor's or subcontractor's agent who pays or supervises the payment of the persons working on the contract, and must certify the following:

(i) That the certified payroll for the payroll period contains the information required to be provided under paragraph 3.b. of this section, the appropriate information and basic records are being maintained under paragraph 3.a. of this section, and such information and records are correct and complete;

(ii) That each laborer or mechanic (including each helper and apprentice) working on the contract during the payroll period has been paid the full weekly wages earned, without rebate, either directly or indirectly, and that no deductions have been made either directly or indirectly from the full wages earned, other than permissible deductions as set forth in [29 CFR part 3](#); and

(iii) That each laborer or mechanic has been paid not less than the applicable wage rates and fringe benefits or cash equivalents for the classification(s) of work actually performed, as specified in the applicable wage determination incorporated into the contract.

(4) *Use of Optional Form WH-347.* The weekly submission of a properly executed certification set forth on the reverse side of Optional Form WH-347 will satisfy the requirement for submission of the "Statement of Compliance" required by paragraph 3.b.(3) of this section.



(5) *Signature.* The signature by the contractor, subcontractor, or the contractor's or subcontractor's agent must be an original handwritten signature or a legally valid electronic signature.

(6) *Falsification.* The falsification of any of the above certifications may subject the contractor or subcontractor to civil or criminal prosecution under [18 U.S.C. 1001](#) and [31 U.S.C. 3729](#).

(7) *Length of certified payroll retention.* The contractor or subcontractor must preserve all certified payrolls during the course of the work and for a period of 3 years after all the work on the prime contract is completed.

c. *Contracts, subcontracts, and related documents.* The contractor or subcontractor must maintain this contract or subcontract and related documents including, without limitation, bids, proposals, amendments, modifications, and extensions. The contractor or subcontractor must preserve these contracts, subcontracts, and related documents during the course of the work and for a period of 3 years after all the work on the prime contract is completed.

d. *Required disclosures and access (1) Required record disclosures and access to workers.* The contractor or subcontractor must make the records required under paragraphs 3.a. through 3.c. of this section, and any other documents that the contracting agency, the State DOT, the FHWA, or the Department of Labor deems necessary to determine compliance with the labor standards provisions of any of the applicable statutes referenced by § 5.1, available for inspection, copying, or transcription by authorized representatives of the contracting agency, the State DOT, the FHWA, or the Department of Labor, and must permit such representatives to interview workers during working hours on the job.

(2) *Sanctions for non-compliance with records and worker access requirements.* If the contractor or subcontractor fails to submit the required records or to make them available, or refuses to permit worker interviews during working hours on the job, the Federal agency may, after written notice to the contractor, sponsor, applicant, owner, or other entity, as the case may be, that maintains such records or that employs such workers, take such action as may be necessary to cause the suspension of any further payment, advance, or guarantee of funds. Furthermore, failure to submit the required records upon request or to make such records available, or to permit worker interviews during working hours on the job, may be grounds for debarment action pursuant to § 5.12. In addition, any contractor or other person that fails to submit the required records or make those records available to WHD within the time WHD requests that the records be produced will be precluded from introducing as evidence in an administrative proceeding under [29 CFR part 6](#) any of the required records that were not provided or made available to WHD. WHD will take into consideration a reasonable request from the contractor or person for an extension of the time for submission of records. WHD will determine the reasonableness of the request and may consider, among other things, the location of the records and the volume of production.

(3) *Required information disclosures.* Contractors and subcontractors must maintain the full Social Security number and last known address, telephone number, and email address

of each covered worker, and must provide them upon request to the contracting agency, the State DOT, the FHWA, the contractor, or the Wage and Hour Division of the Department of Labor for purposes of an investigation or other compliance action.

#### 4. Apprentices and equal employment opportunity (29 CFR 5.5)

a. *Apprentices (1) Rate of pay.* Apprentices will be permitted to work at less than the predetermined rate for the work they perform when they are employed pursuant to and individually registered in a bona fide apprenticeship program registered with the U.S. Department of Labor, Employment and Training Administration, Office of Apprenticeship (OA), or with a State Apprenticeship Agency recognized by the OA. A person who is not individually registered in the program, but who has been certified by the OA or a State Apprenticeship Agency (where appropriate) to be eligible for probationary employment as an apprentice, will be permitted to work at less than the predetermined rate for the work they perform in the first 90 days of probationary employment as an apprentice in such a program. In the event the OA or a State Apprenticeship Agency recognized by the OA withdraws approval of an apprenticeship program, the contractor will no longer be permitted to use apprentices at less than the applicable predetermined rate for the work performed until an acceptable program is approved.

(2) *Fringe benefits.* Apprentices must be paid fringe benefits in accordance with the provisions of the apprenticeship program. If the apprenticeship program does not specify fringe benefits, apprentices must be paid the full amount of fringe benefits listed on the wage determination for the applicable classification. If the Administrator determines that a different practice prevails for the applicable apprentice classification, fringe benefits must be paid in accordance with that determination.

(3) *Apprenticeship ratio.* The allowable ratio of apprentices to journeyworkers on the job site in any craft classification must not be greater than the ratio permitted to the contractor as to the entire work force under the registered program or the ratio applicable to the locality of the project pursuant to paragraph 4.a.(4) of this section. Any worker listed on a payroll at an apprentice wage rate, who is not registered or otherwise employed as stated in paragraph 4.a.(1) of this section, must be paid not less than the applicable wage rate on the wage determination for the classification of work actually performed. In addition, any apprentice performing work on the job site in excess of the ratio permitted under this section must be paid not less than the applicable wage rate on the wage determination for the work actually performed.

(4) *Reciprocity of ratios and wage rates.* Where a contractor is performing construction on a project in a locality other than the locality in which its program is registered, the ratios and wage rates (expressed in percentages of the journeyworker's hourly rate) applicable within the locality in which the construction is being performed must be observed. If there is no applicable ratio or wage rate for the locality of the project, the ratio and wage rate specified in the contractor's registered program must be observed.

b. *Equal employment opportunity.* The use of apprentices and journeyworkers under this part must be in conformity with

the equal employment opportunity requirements of Executive Order 11246, as amended, and [29 CFR part 30](#).

c. Apprentices and Trainees (programs of the U.S. DOT).

Apprentices and trainees working under apprenticeship and skill training programs which have been certified by the Secretary of Transportation as promoting EEO in connection with Federal-aid highway construction programs are not subject to the requirements of paragraph 4 of this Section IV. 23 CFR 230.111(e)(2). The straight time hourly wage rates for apprentices and trainees under such programs will be established by the particular programs. The ratio of apprentices and trainees to journeyworkers shall not be greater than permitted by the terms of the particular program.

**5. Compliance with Copeland Act requirements.** The contractor shall comply with the requirements of 29 CFR part 3, which are incorporated by reference in this contract as provided in 29 CFR 5.5.

**6. Subcontracts.** The contractor or subcontractor must insert FHWA-1273 in any subcontracts, along with the applicable wage determination(s) and such other clauses or contract modifications as the contracting agency may by appropriate instructions require, and a clause requiring the subcontractors to include these clauses and wage determination(s) in any lower tier subcontracts. The prime contractor is responsible for the compliance by any subcontractor or lower tier subcontractor with all the contract clauses in this section. In the event of any violations of these clauses, the prime contractor and any subcontractor(s) responsible will be liable for any unpaid wages and monetary relief, including interest from the date of the underpayment or loss, due to any workers of lower-tier subcontractors, and may be subject to debarment, as appropriate. 29 CFR 5.5.

**7. Contract termination: debarment.** A breach of the contract clauses in 29 CFR 5.5 may be grounds for termination of the contract, and for debarment as a contractor and a subcontractor as provided in 29 CFR 5.12.

**8. Compliance with Davis-Bacon and Related Act requirements.** All rulings and interpretations of the Davis-Bacon and Related Acts contained in 29 CFR parts 1, 3, and 5 are herein incorporated by reference in this contract as provided in 29 CFR 5.5.

**9. Disputes concerning labor standards.** As provided in 29 CFR 5.5, disputes arising out of the labor standards provisions of this contract shall not be subject to the general disputes clause of this contract. Such disputes shall be resolved in accordance with the procedures of the Department of Labor set forth in 29 CFR parts 5, 6, and 7. Disputes within the meaning of this clause include disputes between the contractor (or any of its subcontractors) and the contracting agency, the U.S. Department of Labor, or the employees or their representatives.

**10. Certification of eligibility.** a. By entering into this contract, the contractor certifies that neither it nor any person or firm who has an interest in the contractor's firm is a person or firm ineligible to be awarded Government contracts by virtue of [40 U.S.C. 3144\(b\)](#) or § 5.12(a).

b. No part of this contract shall be subcontracted to any person or firm ineligible for award of a Government contract by virtue of [40 U.S.C. 3144\(b\)](#) or § 5.12(a).

c. The penalty for making false statements is prescribed in the U.S. Code, Title 18 Crimes and Criminal Procedure, [18 U.S.C. 1001](#).

**11. Anti-retaliation.** It is unlawful for any person to discharge, demote, intimidate, threaten, restrain, coerce, blacklist, harass, or in any other manner discriminate against, or to cause any person to discharge, demote, intimidate, threaten, restrain, coerce, blacklist, harass, or in any other manner discriminate against, any worker or job applicant for:

a. Notifying any contractor of any conduct which the worker reasonably believes constitutes a violation of the DBA, Related Acts, this part, or [29 CFR part 1](#) or [3](#);

b. Filing any complaint, initiating or causing to be initiated any proceeding, or otherwise asserting or seeking to assert on behalf of themselves or others any right or protection under the DBA, Related Acts, this part, or [29 CFR part 1](#) or [3](#);

c. Cooperating in any investigation or other compliance action, or testifying in any proceeding under the DBA, Related Acts, this part, or [29 CFR part 1](#) or [3](#); or

d. Informing any other person about their rights under the DBA, Related Acts, this part, or [29 CFR part 1](#) or [3](#).

## V. CONTRACT WORK HOURS AND SAFETY STANDARDS ACT

Pursuant to 29 CFR 5.5(b), the following clauses apply to any Federal-aid construction contract in an amount in excess of \$100,000 and subject to the overtime provisions of the Contract Work Hours and Safety Standards Act. These clauses shall be inserted in addition to the clauses required by 29 CFR 5.5(a) or 29 CFR 4.6. As used in this paragraph, the terms laborers and mechanics include watchpersons and guards.

**1. Overtime requirements.** No contractor or subcontractor contracting for any part of the contract work which may require or involve the employment of laborers or mechanics shall require or permit any such laborer or mechanic in any workweek in which he or she is employed on such work to work in excess of forty hours in such workweek unless such laborer or mechanic receives compensation at a rate not less than one and one-half times the basic rate of pay for all hours worked in excess of forty hours in such workweek. 29 CFR 5.5.

**2. Violation; liability for unpaid wages; liquidated damages.** In the event of any violation of the clause set forth in paragraph 1. of this section the contractor and any subcontractor responsible therefor shall be liable for the unpaid wages and interest from the date of the underpayment. In addition, such contractor and subcontractor shall be liable to the United States (in the case of work done under contract for the District of Columbia or a territory, to such District or to such territory), for liquidated damages. Such liquidated damages shall be computed with respect to each individual laborer or

mechanic, including watchpersons and guards, employed in violation of the clause set forth in paragraph 1. of this section, in the sum currently provided in 29 CFR 5.5(b)(2)\* for each calendar day on which such individual was required or permitted to work in excess of the standard workweek of forty hours without payment of the overtime wages required by the clause set forth in paragraph 1. of this section.

\* \$31 as of January 15, 2023 (See 88 FR 88 FR 2210) as may be adjusted annually by the Department of Labor, pursuant to the Federal Civil Penalties Inflation Adjustment Act of 1990.

### 3. Withholding for unpaid wages and liquidated damages

a. *Withholding process.* The FHWA or the contracting agency may, upon its own action, or must, upon written request of an authorized representative of the Department of Labor, withhold or cause to be withheld from the contractor so much of the accrued payments or advances as may be considered necessary to satisfy the liabilities of the prime contractor or any subcontractor for any unpaid wages; monetary relief, including interest; and liquidated damages required by the clauses set forth in this section on this contract, any other Federal contract with the same prime contractor, or any other federally assisted contract subject to the Contract Work Hours and Safety Standards Act that is held by the same prime contractor (as defined in § 5.2). The necessary funds may be withheld from the contractor under this contract, any other Federal contract with the same prime contractor, or any other federally assisted contract that is subject to the Contract Work Hours and Safety Standards Act and is held by the same prime contractor, regardless of whether the other contract was awarded or assisted by the same agency, and such funds may be used to satisfy the contractor liability for which the funds were withheld.

b. *Priority to withheld funds.* The Department has priority to funds withheld or to be withheld in accordance with Section IV paragraph 2.a. or paragraph 3.a. of this section, or both, over claims to those funds by:

- (1) A contractor's surety(ies), including without limitation performance bond sureties and payment bond sureties;
- (2) A contracting agency for its reprocurement costs;
- (3) A trustee(s) (either a court-appointed trustee or a U.S. trustee, or both) in bankruptcy of a contractor, or a contractor's bankruptcy estate;
- (4) A contractor's assignee(s);
- (5) A contractor's successor(s); or
- (6) A claim asserted under the Prompt Payment Act, [31 U.S.C. 3901–3907](#).

**4. Subcontracts.** The contractor or subcontractor must insert in any subcontracts the clauses set forth in paragraphs 1. through 5. of this section and a clause requiring the subcontractors to include these clauses in any lower tier subcontracts. The prime contractor is responsible for compliance by any subcontractor or lower tier subcontractor with the clauses set forth in paragraphs 1. through 5. In the

event of any violations of these clauses, the prime contractor and any subcontractor(s) responsible will be liable for any unpaid wages and monetary relief, including interest from the date of the underpayment or loss, due to any workers of lower-tier subcontractors, and associated liquidated damages and may be subject to debarment, as appropriate.

**5. Anti-retaliation.** It is unlawful for any person to discharge, demote, intimidate, threaten, restrain, coerce, blacklist, harass, or in any other manner discriminate against, or to cause any person to discharge, demote, intimidate, threaten, restrain, coerce, blacklist, harass, or in any other manner discriminate against, any worker or job applicant for:

a. Notifying any contractor of any conduct which the worker reasonably believes constitutes a violation of the Contract Work Hours and Safety Standards Act (CWHSSA) or its implementing regulations in this part;

b. Filing any complaint, initiating or causing to be initiated any proceeding, or otherwise asserting or seeking to assert on behalf of themselves or others any right or protection under CWHSSA or this part;

c. Cooperating in any investigation or other compliance action, or testifying in any proceeding under CWHSSA or this part; or

d. Informing any other person about their rights under CWHSSA or this part.

### VI. SUBLETTING OR ASSIGNING THE CONTRACT

This provision is applicable to all Federal-aid construction contracts on the National Highway System pursuant to 23 CFR 635.116.

1. The contractor shall perform with its own organization contract work amounting to not less than 30 percent (or a greater percentage if specified elsewhere in the contract) of the total original contract price, excluding any specialty items designated by the contracting agency. Specialty items may be performed by subcontract and the amount of any such specialty items performed may be deducted from the total original contract price before computing the amount of work required to be performed by the contractor's own organization (23 CFR 635.116).

a. The term "perform work with its own organization" in paragraph 1 of Section VI refers to workers employed or leased by the prime contractor, and equipment owned or rented by the prime contractor, with or without operators. Such term does not include employees or equipment of a subcontractor or lower tier subcontractor, agents of the prime contractor, or any other assignees. The term may include payments for the costs of hiring leased employees from an employee leasing firm meeting all relevant Federal and State regulatory requirements. Leased employees may only be included in this term if the prime contractor meets all of the following conditions: (based on longstanding interpretation)

(1) the prime contractor maintains control over the supervision of the day-to-day activities of the leased employees;

(2) the prime contractor remains responsible for the quality of the work of the leased employees;

- (3) the prime contractor retains all power to accept or exclude individual employees from work on the project; and
- (4) the prime contractor remains ultimately responsible for the payment of predetermined minimum wages, the submission of payrolls, statements of compliance and all other Federal regulatory requirements.

b. "Specialty Items" shall be construed to be limited to work that requires highly specialized knowledge, abilities, or equipment not ordinarily available in the type of contracting organizations qualified and expected to bid or propose on the contract as a whole and in general are to be limited to minor components of the overall contract. 23 CFR 635.102.

2. Pursuant to 23 CFR 635.116(a), the contract amount upon which the requirements set forth in paragraph (1) of Section VI is computed includes the cost of material and manufactured products which are to be purchased or produced by the contractor under the contract provisions.

3. Pursuant to 23 CFR 635.116(c), the contractor shall furnish (a) a competent superintendent or supervisor who is employed by the firm, has full authority to direct performance of the work in accordance with the contract requirements, and is in charge of all construction operations (regardless of who performs the work) and (b) such other of its own organizational resources (supervision, management, and engineering services) as the contracting officer determines is necessary to assure the performance of the contract.

4. No portion of the contract shall be sublet, assigned or otherwise disposed of except with the written consent of the contracting officer, or authorized representative, and such consent when given shall not be construed to relieve the contractor of any responsibility for the fulfillment of the contract. Written consent will be given only after the contracting agency has assured that each subcontract is evidenced in writing and that it contains all pertinent provisions and requirements of the prime contract. (based on long-standing interpretation of 23 CFR 635.116).

5. The 30-percent self-performance requirement of paragraph (1) is not applicable to design-build contracts; however, contracting agencies may establish their own self-performance requirements. 23 CFR 635.116(d).

#### **VII. SAFETY: ACCIDENT PREVENTION**

This provision is applicable to all Federal-aid construction contracts and to all related subcontracts.

1. In the performance of this contract the contractor shall comply with all applicable Federal, State, and local laws governing safety, health, and sanitation (23 CFR Part 635). The contractor shall provide all safeguards, safety devices and protective equipment and take any other needed actions as it determines, or as the contracting officer may determine, to be reasonably necessary to protect the life and health of employees on the job and the safety of the public and to protect property in connection with the performance of the work covered by the contract. 23 CFR 635.108.

2. It is a condition of this contract, and shall be made a condition of each subcontract, which the contractor enters into pursuant to this contract, that the contractor and any subcontractor shall not permit any employee, in performance of the contract, to work in surroundings or under conditions which are unsanitary, hazardous or dangerous to his/her health or safety, as determined under construction safety and

health standards (29 CFR Part 1926) promulgated by the Secretary of Labor, in accordance with Section 107 of the Contract Work Hours and Safety Standards Act (40 U.S.C. 3704). 29 CFR 1926.10.

3. Pursuant to 29 CFR 1926.3, it is a condition of this contract that the Secretary of Labor or authorized representative thereof, shall have right of entry to any site of contract performance to inspect or investigate the matter of compliance with the construction safety and health standards and to carry out the duties of the Secretary under Section 107 of the Contract Work Hours and Safety Standards Act (40 U.S.C. 3704).

#### **VIII. FALSE STATEMENTS CONCERNING HIGHWAY PROJECTS**

This provision is applicable to all Federal-aid construction contracts and to all related subcontracts.

In order to assure high quality and durable construction in conformity with approved plans and specifications and a high degree of reliability on statements and representations made by engineers, contractors, suppliers, and workers on Federal-aid highway projects, it is essential that all persons concerned with the project perform their functions as carefully, thoroughly, and honestly as possible. Willful falsification, distortion, or misrepresentation with respect to any facts related to the project is a violation of Federal law. To prevent any misunderstanding regarding the seriousness of these and similar acts, Form FHWA-1022 shall be posted on each Federal-aid highway project (23 CFR Part 635) in one or more places where it is readily available to all persons concerned with the project:

18 U.S.C. 1020 reads as follows:

"Whoever, being an officer, agent, or employee of the United States, or of any State or Territory, or whoever, whether a person, association, firm, or corporation, knowingly makes any false statement, false representation, or false report as to the character, quality, quantity, or cost of the material used or to be used, or the quantity or quality of the work performed or to be performed, or the cost thereof in connection with the submission of plans, maps, specifications, contracts, or costs of construction on any highway or related project submitted for approval to the Secretary of Transportation; or

Whoever knowingly makes any false statement, false representation, false report or false claim with respect to the character, quality, quantity, or cost of any work performed or to be performed, or materials furnished or to be furnished, in connection with the construction of any highway or related project approved by the Secretary of Transportation; or

Whoever knowingly makes any false statement or false representation as to material fact in any statement, certificate, or report submitted pursuant to provisions of the Federal-aid Roads Act approved July 11, 1916, (39 Stat. 355), as amended and supplemented;

Shall be fined under this title or imprisoned not more than 5 years or both."



**IX. IMPLEMENTATION OF CLEAN AIR ACT AND FEDERAL WATER POLLUTION CONTROL ACT (42 U.S.C. 7606; 2 CFR 200.88; EO 11738)**

This provision is applicable to all Federal-aid construction contracts in excess of \$150,000 and to all related subcontracts. 48 CFR 2.101; 2 CFR 200.327.

By submission of this bid/proposal or the execution of this contract or subcontract, as appropriate, the bidder, proposer, Federal-aid construction contractor, subcontractor, supplier, or vendor agrees to comply with all applicable standards, orders or regulations issued pursuant to the Clean Air Act (42 U.S.C. 7401-7671q) and the Federal Water Pollution Control Act, as amended (33 U.S.C. 1251-1387). Violations must be reported to the Federal Highway Administration and the Regional Office of the Environmental Protection Agency. 2 CFR Part 200, Appendix II.

The contractor agrees to include or cause to be included the requirements of this Section in every subcontract, and further agrees to take such action as the contracting agency may direct as a means of enforcing such requirements. 2 CFR 200.327.

**X. CERTIFICATION REGARDING DEBARMENT, SUSPENSION, INELIGIBILITY AND VOLUNTARY EXCLUSION**

This provision is applicable to all Federal-aid construction contracts, design-build contracts, subcontracts, lower-tier subcontracts, purchase orders, lease agreements, consultant contracts or any other covered transaction requiring FHWA approval or that is estimated to cost \$25,000 or more – as defined in 2 CFR Parts 180 and 1200. 2 CFR 180.220 and 1200.220.

**1. Instructions for Certification – First Tier Participants:**

a. By signing and submitting this proposal, the prospective first tier participant is providing the certification set out below.

b. The inability of a person to provide the certification set out below will not necessarily result in denial of participation in this covered transaction. The prospective first tier participant shall submit an explanation of why it cannot provide the certification set out below. The certification or explanation will be considered in connection with the department or agency's determination whether to enter into this transaction. However, failure of the prospective first tier participant to furnish a certification or an explanation shall disqualify such a person from participation in this transaction. 2 CFR 180.320.

c. The certification in this clause is a material representation of fact upon which reliance was placed when the contracting agency determined to enter into this transaction. If it is later determined that the prospective participant knowingly rendered an erroneous certification, in addition to other remedies available to the Federal Government, the contracting agency may terminate this transaction for cause of default. 2 CFR 180.325.

d. The prospective first tier participant shall provide immediate written notice to the contracting agency to whom this proposal is submitted if any time the prospective first tier participant learns that its certification was erroneous when submitted or has become erroneous by reason of changed circumstances. 2 CFR 180.345 and 180.350.

e. The terms "covered transaction," "debarred," "suspended," "ineligible," "participant," "person," "principal," and "voluntarily excluded," as used in this clause, are defined in 2 CFR Parts 180, Subpart I, 180.900-180.1020, and 1200. "First Tier Covered Transactions" refers to any covered transaction between a recipient or subrecipient of Federal funds and a participant (such as the prime or general contract). "Lower Tier Covered Transactions" refers to any covered transaction under a First Tier Covered Transaction (such as subcontracts). "First Tier Participant" refers to the participant who has entered into a covered transaction with a recipient or subrecipient of Federal funds (such as the prime or general contractor). "Lower Tier Participant" refers any participant who has entered into a covered transaction with a First Tier Participant or other Lower Tier Participants (such as subcontractors and suppliers).

f. The prospective first tier participant agrees by submitting this proposal that, should the proposed covered transaction be entered into, it shall not knowingly enter into any lower tier covered transaction with a person who is debarred, suspended, declared ineligible, or voluntarily excluded from participation in this covered transaction, unless authorized by the department or agency entering into this transaction. 2 CFR 180.330.

g. The prospective first tier participant further agrees by submitting this proposal that it will include the clause titled "Certification Regarding Debarment, Suspension, Ineligibility and Voluntary Exclusion-Lower Tier Covered Transactions," provided by the department or contracting agency, entering into this covered transaction, without modification, in all lower tier covered transactions and in all solicitations for lower tier covered transactions exceeding the \$25,000 threshold. 2 CFR 180.220 and 180.300.

h. A participant in a covered transaction may rely upon a certification of a prospective participant in a lower tier covered transaction that is not debarred, suspended, ineligible, or voluntarily excluded from the covered transaction, unless it knows that the certification is erroneous. 2 CFR 180.300; 180.320, and 180.325. A participant is responsible for ensuring that its principals are not suspended, debarred, or otherwise ineligible to participate in covered transactions. 2 CFR 180.335. To verify the eligibility of its principals, as well as the eligibility of any lower tier prospective participants, each participant may, but is not required to, check the System for Award Management website (<https://www.sam.gov/>). 2 CFR 180.300, 180.320, and 180.325.

i. Nothing contained in the foregoing shall be construed to require the establishment of a system of records in order to render in good faith the certification required by this clause. The knowledge and information of the prospective participant is not required to exceed that which is normally possessed by a prudent person in the ordinary course of business dealings.

j. Except for transactions authorized under paragraph (f) of these instructions, if a participant in a covered transaction knowingly enters into a lower tier covered transaction with a person who is suspended, debarred, ineligible, or voluntarily excluded from participation in this transaction, in addition to other remedies available to the Federal Government, the department or agency may terminate this transaction for cause or default. 2 CFR 180.325.

\*\*\*\*\*

**2. Certification Regarding Debarment, Suspension, Ineligibility and Voluntary Exclusion – First Tier Participants:**

a. The prospective first tier participant certifies to the best of its knowledge and belief, that it and its principals:

(1) Are not presently debarred, suspended, proposed for debarment, declared ineligible, or voluntarily excluded from participating in covered transactions by any Federal department or agency, 2 CFR 180.335;

(2) Have not within a three-year period preceding this proposal been convicted of or had a civil judgment rendered against them for commission of fraud or a criminal offense in connection with obtaining, attempting to obtain, or performing a public (Federal, State, or local) transaction or contract under a public transaction; violation of Federal or State antitrust statutes or commission of embezzlement, theft, forgery, bribery, falsification or destruction of records, making false statements, or receiving stolen property, 2 CFR 180.800;

(3) Are not presently indicted for or otherwise criminally or civilly charged by a governmental entity (Federal, State or local) with commission of any of the offenses enumerated in paragraph (a)(2) of this certification, 2 CFR 180.700 and 180.800; and

(4) Have not within a three-year period preceding this application/proposal had one or more public transactions (Federal, State or local) terminated for cause or default. 2 CFR 180.335(d).

(5) Are not a corporation that has been convicted of a felony violation under any Federal law within the two-year period preceding this proposal (USDOT Order 4200.6 implementing appropriations act requirements); and

(6) Are not a corporation with any unpaid Federal tax liability that has been assessed, for which all judicial and administrative remedies have been exhausted, or have lapsed, and that is not being paid in a timely manner pursuant to an agreement with the authority responsible for collecting the tax liability (USDOT Order 4200.6 implementing appropriations act requirements).

b. Where the prospective participant is unable to certify to any of the statements in this certification, such prospective participant should attach an explanation to this proposal. 2 CFR 180.335 and 180.340.

\* \* \* \* \*

**3. Instructions for Certification - Lower Tier Participants:**

(Applicable to all subcontracts, purchase orders, and other lower tier transactions requiring prior FHWA approval or estimated to cost \$25,000 or more - 2 CFR Parts 180 and 1200). 2 CFR 180.220 and 1200.220.

a. By signing and submitting this proposal, the prospective lower tier participant is providing the certification set out below.

b. The certification in this clause is a material representation of fact upon which reliance was placed when this transaction was entered into. If it is later determined that the prospective lower tier participant knowingly rendered an erroneous certification, in addition to other remedies available to the Federal Government, the department, or agency with which

this transaction originated may pursue available remedies, including suspension and/or debarment.

c. The prospective lower tier participant shall provide immediate written notice to the person to which this proposal is submitted if at any time the prospective lower tier participant learns that its certification was erroneous by reason of changed circumstances. 2 CFR 180.365.

d. The terms "covered transaction," "debarred," "suspended," "ineligible," "participant," "person," "principal," and "voluntarily excluded," as used in this clause, are defined in 2 CFR Parts 180, Subpart I, 180.900 – 180.1020, and 1200. You may contact the person to which this proposal is submitted for assistance in obtaining a copy of those regulations. "First Tier Covered Transactions" refers to any covered transaction between a recipient or subrecipient of Federal funds and a participant (such as the prime or general contract). "Lower Tier Covered Transactions" refers to any covered transaction under a First Tier Covered Transaction (such as subcontracts). "First Tier Participant" refers to the participant who has entered into a covered transaction with a recipient or subrecipient of Federal funds (such as the prime or general contractor). "Lower Tier Participant" refers any participant who has entered into a covered transaction with a First Tier Participant or other Lower Tier Participants (such as subcontractors and suppliers).

e. The prospective lower tier participant agrees by submitting this proposal that, should the proposed covered transaction be entered into, it shall not knowingly enter into any lower tier covered transaction with a person who is debarred, suspended, declared ineligible, or voluntarily excluded from participation in this covered transaction, unless authorized by the department or agency with which this transaction originated. 2 CFR 1200.220 and 1200.332.

f. The prospective lower tier participant further agrees by submitting this proposal that it will include this clause titled "Certification Regarding Debarment, Suspension, Ineligibility and Voluntary Exclusion-Lower Tier Covered Transaction," without modification, in all lower tier covered transactions and in all solicitations for lower tier covered transactions exceeding the \$25,000 threshold. 2 CFR 180.220 and 1200.220.

g. A participant in a covered transaction may rely upon a certification of a prospective participant in a lower tier covered transaction that is not debarred, suspended, ineligible, or voluntarily excluded from the covered transaction, unless it knows that the certification is erroneous. A participant is responsible for ensuring that its principals are not suspended, debarred, or otherwise ineligible to participate in covered transactions. To verify the eligibility of its principals, as well as the eligibility of any lower tier prospective participants, each participant may, but is not required to, check the System for Award Management website (<https://www.sam.gov>), which is compiled by the General Services Administration. 2 CFR 180.300, 180.320, 180.330, and 180.335.

h. Nothing contained in the foregoing shall be construed to require establishment of a system of records in order to render in good faith the certification required by this clause. The knowledge and information of participant is not required to exceed that which is normally possessed by a prudent person in the ordinary course of business dealings.

i. Except for transactions authorized under paragraph e of these instructions, if a participant in a covered transaction knowingly enters into a lower tier covered transaction with a person who is suspended, debarred, ineligible, or voluntarily

excluded from participation in this transaction, in addition to other remedies available to the Federal Government, the department or agency with which this transaction originated may pursue available remedies, including suspension and/or debarment. 2 CFR 180.325.

\* \* \* \* \*

**4. Certification Regarding Debarment, Suspension, Ineligibility and Voluntary Exclusion--Lower Tier Participants:**

a. The prospective lower tier participant certifies, by submission of this proposal, that neither it nor its principals:

(1) is presently debarred, suspended, proposed for debarment, declared ineligible, or voluntarily excluded from participating in covered transactions by any Federal department or agency, 2 CFR 180.355;

(2) is a corporation that has been convicted of a felony violation under any Federal law within the two-year period preceding this proposal (USDOT Order 4200.6 implementing appropriations act requirements); and

(3) is a corporation with any unpaid Federal tax liability that has been assessed, for which all judicial and administrative remedies have been exhausted, or have lapsed, and that is not being paid in a timely manner pursuant to an agreement with the authority responsible for collecting the tax liability. (USDOT Order 4200.6 implementing appropriations act requirements)

b. Where the prospective lower tier participant is unable to certify to any of the statements in this certification, such prospective participant should attach an explanation to this proposal.

\* \* \* \* \*

**XI. CERTIFICATION REGARDING USE OF CONTRACT FUNDS FOR LOBBYING**

This provision is applicable to all Federal-aid construction contracts and to all related subcontracts which exceed \$100,000. 49 CFR Part 20, App. A.

1. The prospective participant certifies, by signing and submitting this bid or proposal, to the best of his or her knowledge and belief, that:

a. No Federal appropriated funds have been paid or will be paid, by or on behalf of the undersigned, to any person for influencing or attempting to influence an officer or employee of any Federal agency, a Member of Congress, an officer or employee of Congress, or an employee of a Member of Congress in connection with the awarding of any Federal contract, the making of any Federal grant, the making of any Federal loan, the entering into of any cooperative agreement, and the extension, continuation, renewal, amendment, or modification of any Federal contract, grant, loan, or cooperative agreement.

b. If any funds other than Federal appropriated funds have been paid or will be paid to any person for influencing or attempting to influence an officer or employee of any Federal agency, a Member of Congress, an officer or employee of Congress, or an employee of a Member of Congress in connection with this Federal contract, grant, loan, or

cooperative agreement, the undersigned shall complete and submit Standard Form-LLL, "Disclosure Form to Report Lobbying," in accordance with its instructions.

2. This certification is a material representation of fact upon which reliance was placed when this transaction was made or entered into. Submission of this certification is a prerequisite for making or entering into this transaction imposed by 31 U.S.C. 1352. Any person who fails to file the required certification shall be subject to a civil penalty of not less than \$10,000 and not more than \$100,000 for each such failure.

3. The prospective participant also agrees by submitting its bid or proposal that the participant shall require that the language of this certification be included in all lower tier subcontracts, which exceed \$100,000 and that all such recipients shall certify and disclose accordingly.

**XII. USE OF UNITED STATES-FLAG VESSELS:**

This provision is applicable to all Federal-aid construction contracts, design-build contracts, subcontracts, lower-tier subcontracts, purchase orders, lease agreements, or any other covered transaction. 46 CFR Part 381.

This requirement applies to material or equipment that is acquired for a specific Federal-aid highway project. 46 CFR 381.7. It is not applicable to goods or materials that come into inventories independent of an FHWA funded-contract.

When oceanic shipments (or shipments across the Great Lakes) are necessary for materials or equipment acquired for a specific Federal-aid construction project, the bidder, proposer, contractor, subcontractor, or vendor agrees:

1. To utilize privately owned United States-flag commercial vessels to ship at least 50 percent of the gross tonnage (computed separately for dry bulk carriers, dry cargo liners, and tankers) involved, whenever shipping any equipment, material, or commodities pursuant to this contract, to the extent such vessels are available at fair and reasonable rates for United States-flag commercial vessels. 46 CFR 381.7.

2. To furnish within 20 days following the date of loading for shipments originating within the United States or within 30 working days following the date of loading for shipments originating outside the United States, a legible copy of a rated, 'on-board' commercial ocean bill-of-lading in English for each shipment of cargo described in paragraph (b)(1) of this section to both the Contracting Officer (through the prime contractor in the case of subcontractor bills-of-lading) and to the Office of Cargo and Commercial Sealift (MAR-620), Maritime Administration, Washington, DC 20590. (MARAD requires copies of the ocean carrier's (master) bills of lading, certified onboard, dated, with rates and charges. These bills of lading may contain business sensitive information and therefore may be submitted directly to MARAD by the Ocean Transportation Intermediary on behalf of the contractor). 46 CFR 381.7.

**ATTACHMENT A - EMPLOYMENT AND MATERIALS PREFERENCE FOR APPALACHIAN DEVELOPMENT HIGHWAY SYSTEM OR APPALACHIAN LOCAL ACCESS ROAD CONTRACTS** (23 CFR 633, Subpart B, Appendix B)  
This provision is applicable to all Federal-aid projects funded under the Appalachian Regional Development Act of 1965.

1. During the performance of this contract, the contractor undertaking to do work which is, or reasonably may be, done as on-site work, shall give preference to qualified persons who regularly reside in the labor area as designated by the DOL wherein the contract work is situated, or the subregion, or the Appalachian counties of the State wherein the contract work is situated, except:

a. To the extent that qualified persons regularly residing in the area are not available.

b. For the reasonable needs of the contractor to employ supervisory or specially experienced personnel necessary to assure an efficient execution of the contract work.

c. For the obligation of the contractor to offer employment to present or former employees as the result of a lawful collective bargaining contract, provided that the number of nonresident persons employed under this subparagraph (1c) shall not exceed 20 percent of the total number of employees employed by the contractor on the contract work, except as provided in subparagraph (4) below.

2. The contractor shall place a job order with the State Employment Service indicating (a) the classifications of the laborers, mechanics and other employees required to perform the contract work, (b) the number of employees required in each classification, (c) the date on which the participant estimates such employees will be required, and (d) any other pertinent information required by the State Employment Service to complete the job order form. The job order may be placed with the State Employment Service in writing or by telephone. If during the course of the contract work, the information submitted by the contractor in the original job order is substantially modified, the participant shall promptly notify the State Employment Service.

3. The contractor shall give full consideration to all qualified job applicants referred to him by the State Employment Service. The contractor is not required to grant employment to any job applicants who, in his opinion, are not qualified to perform the classification of work required.

4. If, within one week following the placing of a job order by the contractor with the State Employment Service, the State Employment Service is unable to refer any qualified job applicants to the contractor, or less than the number requested, the State Employment Service will forward a certificate to the contractor indicating the unavailability of applicants. Such certificate shall be made a part of the contractor's permanent project records. Upon receipt of this certificate, the contractor may employ persons who do not normally reside in the labor area to fill positions covered by the certificate, notwithstanding the provisions of subparagraph (1c) above.

5. The provisions of 23 CFR 633.207(e) allow the contracting agency to provide a contractual preference for the use of mineral resource materials native to the Appalachian region.

6. The contractor shall include the provisions of Sections 1 through 4 of this Attachment A in every subcontract for work which is, or reasonably may be, done as on-site work.

**STANDARD SPECIAL PROVISION****ON-THE-JOB TRAINING**

(10-16-07) (Rev. 4-21-15)

Z-10

**Description**

The North Carolina Department of Transportation will administer a custom version of the Federal On-the-Job Training (OJT) Program, commonly referred to as the Alternate OJT Program. All contractors (existing and newcomers) will be automatically placed in the Alternate Program. Standard OJT requirements typically associated with individual projects will no longer be applied at the project level. Instead, these requirements will be applicable on an annual basis for each contractor administered by the OJT Program Manager.

On the Job Training shall meet the requirements of 23 CFR 230.107 (b), 23 USC – Section 140, this provision and the On-the-Job Training Program Manual.

The Alternate OJT Program will allow a contractor to train employees on Federal, State and privately funded projects located in North Carolina. However, priority shall be given to training employees on NCDOT Federal-Aid funded projects.

**Minorities and Women**

Developing, training and upgrading of minorities and women toward journeyman level status is a primary objective of this special training provision. Accordingly, the Contractor shall make every effort to enroll minority and women as trainees to the extent that such persons are available within a reasonable area of recruitment. This training commitment is not intended, and shall not be used, to discriminate against any applicant for training, whether a member of a minority group or not.

**Assigning Training Goals**

The Department, through the OJT Program Manager, will assign training goals for a calendar year based on the contractors' past three years' activity and the contractors' anticipated upcoming year's activity with the Department. At the beginning of each year, all contractors eligible will be contacted by the Department to determine the number of trainees that will be assigned for the upcoming calendar year. At that time the Contractor shall enter into an agreement with the Department to provide a self-imposed on-the-job training program for the calendar year. This agreement will include a specific number of annual training goals agreed to by both parties. The number of training assignments may range from 1 to 15 per contractor per calendar year. The Contractor shall sign an agreement to fulfill their annual goal for the year.\

### **Training Classifications**

The Contractor shall provide on-the-job training aimed at developing full journeyman level workers in the construction craft/operator positions. Preference shall be given to providing training in the following skilled work classifications:

Equipment Operators	Office Engineers
Truck Drivers	Estimators
Carpenters	Iron / Reinforcing Steel Workers
Concrete Finishers	Mechanics
Pipe Layers	Welders

The Department has established common training classifications and their respective training requirements that may be used by the contractors. However, the classifications established are not all-inclusive. Where the training is oriented toward construction applications, training will be allowed in lower-level management positions such as office engineers and estimators. Contractors shall submit new classifications for specific job functions that their employees are performing. The Department will review and recommend for acceptance to FHWA the new classifications proposed by contractors, if applicable. New classifications shall meet the following requirements:

Proposed training classifications are reasonable and realistic based on the job skill classification needs, and

The number of training hours specified in the training classification is consistent with common practices and provides enough time for the trainee to obtain journeyman level status.

The Contractor may allow trainees to be trained by a subcontractor provided that the Contractor retains primary responsibility for meeting the training and this provision is made applicable to the subcontract. However, only the Contractor will receive credit towards the annual goal for the trainee.

Where feasible, 25 percent of apprentices or trainees in each occupation shall be in their first year of apprenticeship or training. The number of trainees shall be distributed among the work classifications on the basis of the contractor's needs and the availability of journeymen in the various classifications within a reasonable area of recruitment.

No employee shall be employed as a trainee in any classification in which they have successfully completed a training course leading to journeyman level status or in which they have been employed as a journeyman.

### **Records and Reports**

The Contractor shall maintain enrollment, monthly and completion reports documenting company compliance under these contract documents. These documents and any other information as requested shall be submitted to the OJT Program Manager.

Upon completion and graduation of the program, the Contractor shall provide each trainee with a certification Certificate showing the type and length of training satisfactorily completed.

### **Trainee Interviews**

All trainees enrolled in the program will receive an initial and Trainee/Post graduate interview conducted by the OJT program staff.

### **Trainee Wages**

Contractors shall compensate trainees on a graduating pay scale based upon a percentage of the prevailing minimum journeyman wages (Davis-Bacon Act). Minimum pay shall be as follows:

60 percent	of the journeyman wage for the first half of the training period
75 percent	of the journeyman wage for the third quarter of the training period
90 percent	of the journeyman wage for the last quarter of the training period

In no instance shall a trainee be paid less than the local minimum wage. The Contractor shall adhere to the minimum hourly wage rate that will satisfy both the NC Department of Labor (NCDOL) and the Department.

### **Achieving or Failing to Meet Training Goals**

The Contractor will be credited for each trainee employed by him on the contract work who is currently enrolled or becomes enrolled in an approved program and who receives training for at least 50 percent of the specific program requirement. Trainees will be allowed to be transferred between projects if required by the Contractor's scheduled workload to meet training goals.

If a contractor fails to attain their training assignments for the calendar year, they may be taken off the NCDOT's Bidders List.

### **Measurement and Payment**

No compensation will be made for providing required training in accordance with these contract documents.

**STANDARD SPECIAL PROVISION**  
**MINIMUM WAGES**  
**GENERAL DECISION NC20240091 01/05/2024 NC91**

Z-091

Date: January 5, 2024

General Decision Number: NC20240091 01/05/2024 NC91

Superseded General Decision Numbers: NC20230091

State: North Carolina

Construction Type: HIGHWAY

**COUNTIES:**

Beaufort	Granville	Pasquotank
Bertie	Halifax	Perquimans
Bladen	Harnett	Robeson
Camden	Hertford	Sampson
Carteret	Hyde	Scotland
Chowan	Jones	Tyrrell
Columbus	Lenoir	Vance
Craven	Martin	Warren
Dare	Northampton	Washington
Duplin	Pamlico	Wilson
Gates		

HIGHWAY CONSTRUCTION PROJECTS (excluding tunnels, building structures in rest area projects & railroad construction; bascule, suspension & spandrel arch bridges designed for commercial navigation, bridges involving marine construction; and other major bridges).

Note: Contracts subject to the Davis-Bacon Act are generally required to pay at least the applicable minimum wage rate required under Executive Order 14026 or Executive Order 13658. Please note that these Executive Orders apply to covered contracts entered into by the federal government that are subject to the Davis-Bacon Act itself, but do not apply to contracts subject only to the Davis-Bacon Related Acts, including those set forth at 29 CFR 5.1(a)(1).



If the contract is entered into on or after January 30, 2022, or the contract is renewed or extended (e.g., an option is exercised) on or after January 30, 2022:	Executive Order 14026 generally applies to the contract.  The contractor must pay all covered workers at least \$17.20 per hour (or the applicable wage rate listed on this wage determination, if it is higher) for all hours spent performing on that contract in 2024.
If the contract was awarded on or between January 1, 2015 and January 29, 2022, and the contract is not renewed or extended on or after January 30, 2022:	Executive Order 13658 generally applies to the contract.  The contractor must pay all covered workers at least \$12.90 per hour (or the applicable wage rate listed on this wage determination, if it is higher) for all hours spent performing on that contract in 2024.

The applicable Executive Order minimum wage rate will be adjusted annually. If this contract is covered by one of the Executive Orders and a classification considered necessary for performance of work on the contract does not appear on this wage determination, the contractor must still submit a conformance request.

Additional information on contractor requirements and worker protections under the Executive Orders is available at <http://www.dol.gov/whd/govcontracts>.

Modification Number  
0

Publication Date  
01/05/2024

SUNC2014-006 11/17/2014

	Rates	Fringes
BLASTER	21.85	
CARPENTER	13.72 **	
CEMENT MASON/CONCRETE FINISHER	14.26 **	
ELECTRICIAN		
Electrician	18.69	2.66
Telecommunications Technician	14.72 **	1.67
IRONWORKER	16.32	
LABORER		
Asphalt Raker and Spreader	12.42 **	
Asphalt Screed/Jackman	13.48 **	
Carpenter Tender	10.85 **	
Cement Mason/Concrete Finisher Tender	11.35 **	
Common or General	10.12 **	
Guardrail/Fence Installer	13.39 **	
Pipelayer	13.31 **	
Traffic Signal/Lighting Installer	16.88	
PAINTER		
Bridge	19.62	
POWER EQUIPMENT OPERATORS		
Asphalt Broom Tractor	13.28 **	
Bulldozer Fine	18.46	
Bulldozer Rough	14.09 **	
Concrete Grinder/Groover	24.66	

	Rates	Fringes
Crane Boom Trucks	17.25	
Crane Other	21.48	
Crane Rough/All-Terrain	19.00	
Drill Operator Rock	15.43 **	1.61
Drill Operator Structure	19.12	
Excavator Fine	17.61	
Excavator Rough	12.99 **	
Grader/Blade Fine	16.73	
Grader/Blade Rough	15.28 **	
Loader 2 Cubic Yards or Less	10.28 **	
Loader Greater Than 2 Cubic Yards	13.58 **	
Material Transfer Vehicle (Shuttle Buggy)	17.39	
Mechanic	18.63	
Milling Machine	14.38 **	
Off-Road Hauler/Water Tanker	9.30 **	
Oiler/Greaser	13.45 **	
Pavement Marking Equipment	11.87 **	
Paver Asphalt	15.53 **	
Roller Asphalt Breakdown	12.13 **	
Roller Asphalt Finish	13.65 **	
Roller Other	10.48 **	
Scraper Finish	13.98 **	
Scraper Rough	10.17 **	
Slip Form Machine	19.29	
Tack Truck/Distributor Operator	14.56 **	
TRUCK DRIVER		
GVWR of 26,000 Lbs or Less	10.35 **	
GVWR of 26,001 Lbs or Greater	12.04 **	

Welders – Receive rate prescribed for craft performing operation to which welding is incidental.

\*\* Workers in this classification may be entitled to a higher minimum wage under Executive Order 14026 (\$17.20) or 13658 (\$12.90). Please see the Note at the top of the wage determination for more information. Please also note that the minimum wage requirements of Executive Order 14026 are not currently being enforced as to any contract or subcontract to which the states of Texas, Louisiana, or Mississippi, including their agencies, are a party.

Note: Executive Order (EO) 13706, Establishing Paid Sick Leave for Federal Contractors applies to all contracts subject to the Davis-Bacon Act for which the contract is awarded (and any solicitation was issued) on or after January 1, 2017. If this contract is covered by the EO, the contractor must provide employees with 1 hour of paid sick leave for every 30 hours they work, up to 56 hours of paid sick leave each year. Employees must be permitted to use paid sick leave for their own illness, injury or other health-related needs, including preventive care; to assist a family member (or person who is like family to the employee) who is ill, injured, or has other health-related needs, including preventive care; or for reasons resulting from, or to assist a family member (or person who is like family to the employee) who is a victim of, domestic violence, sexual assault, or stalking. Additional information on contractor requirements and worker protections under the EO is available at <https://www.dol.gov/agencies/whd/government-contracts>.

Unlisted classifications needed for work not included within the scope of the classifications listed may be added after award only as provided in the labor standards contract clauses (29 CFR 5.5(a)(1)(iii)).

The body of each wage determination lists the classification and wage rates that have been found to be prevailing for the cited type(s) of construction in the area covered by the wage determination. The classifications are listed in alphabetical order of "identifiers" that indicate whether the particular rate is a union rate (current union negotiated rate for local), a survey rate (weighted average rate) or a union average rate (weighted union average rate).

#### Union Rate Identifiers

A four letter classification abbreviation identifier enclosed in dotted lines beginning with characters other than "SU" or "UAVG" denotes that the union classification and rate were prevailing for that classification in the survey. Example: PLUM0198-005 07/01/2014. PLUM is an abbreviation identifier of the union which prevailed in the survey for this classification, which in this example would be Plumbers. 0198 indicates the local union number or district council number where applicable, i.e., Plumbers Local 0198. The next number, 005 in the example, is an internal number used in processing the wage determination. 07/01/2014 is the effective date of the most current negotiated rate, which in this example is July 1, 2014.

Union prevailing wage rates are updated to reflect all rate changes in the collective bargaining agreement (CBA) governing this classification and rate.

#### Survey Rate Identifiers

Classifications listed under the "SU" identifier indicate that no one rate prevailed for this classification in the survey and the published rate is derived by computing a weighted average rate based on all the rates reported in the survey for that classification. As this weighted average rate includes all rates reported in the survey, it may include both union and non-union rates. Example: SULA2012-007 5/13/2014. SU indicates the rates are survey rates based on a weighted average calculation of rates and are not majority rates. LA indicates the State of Louisiana. 2012 is the year of survey on which these classifications and rates are based. The next number, 007 in the example, is an internal number used in producing the wage determination. 5/13/2014 indicates the survey completion date for the classifications and rates under that identifier.

Survey wage rates are not updated and remain in effect until a new survey is conducted.

#### Union Average Rate Identifiers

Classification(s) listed under the UAVG identifier indicate that no single majority rate prevailed for those classifications; however, 100% of the data reported for the classifications was union data. EXAMPLE: UAVG-OH-0010 08/29/2014. UAVG indicates that the rate is a weighted union average rate. OH indicates the state. The next number, 0010 in the example, is an internal number used in producing the wage determination. 08/29/2014 indicates the survey completion date for the classifications and rates under that identifier.

A UAVG rate will be updated once a year, usually in January of each year, to reflect a weighted average of the current negotiated/CBA rate of the union locals from which the rate is based.

## WAGE DETERMINATION APPEALS PROCESS

1.) Has there been an initial decision in the matter? This can be:

- \* an existing published wage determination
- \* a survey underlying a wage determination
- \* a Wage and Hour Division letter setting forth a position on a wage determination matter
- \* a conformance (additional classification and rate) ruling

On survey related matters, initial contact, including requests for summaries of surveys, should be with the Wage and Hour National Office because National Office has responsibility for the David-Bacon survey program. If the response from this initial contact is not satisfactory, then the process described in 2.) and 3.) should be followed.

With regard to any other matter not yet ripe for the formal process described here, initial contact should be with the Branch of Construction Wage Determinations. Write to:

Branch of Construction Wage Determinations  
Wage and Hour Division  
U. S. Department of Labor  
200 Constitution Avenue, N.W.  
Washington, D.C. 20210

2.) If the answer to the question in 1.) is yes, then an interested party (those affected by the action) can request review and reconsideration from the Wage and Hour Administrator (See 29 CFR Part 1.8 and 29 CFR Part 7). Write to:

Wage and Hour Administrator  
U.S. Department of Labor  
200 Constitution Avenue, N.W.  
Washington, D.C. 20210

The request should be accompanied by a full statement of the interested party's position and by any information (wage payment data, project description, area practice material, etc.) that the requestor considers relevant to the issue.

3.) If the decision of the Administrator is not favorable, an interested party may appeal directly to the Administrative Review Board (formerly the Wage Appeals Board). Write to:

Administrative Review Board  
U.S. Department of Labor  
200 Constitution Avenue, N.W.  
Washington, D.C. 20210

4.) All decisions by the Administrative Review Board are final.

END OF GENERAL DECISION

PROJECT SPECIAL PROVISIONS

## Utilities by Others

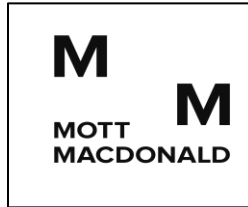
**General:**

The following utility companies have facilities that will be in conflict with the construction of this project:

- A) South River EMC – Power
- B) Star Communications - Telecommunication

The conflicting facilities of these concerns will be adjusted prior to the date of availability, unless otherwise noted and are therefore listed in these special provisions for the benefit of the Contractor. All utility work listed herein will be done by the utility owners. All utilities are shown on the plans from the best available information.

The Contractor's attention is directed to Article 105-8 of the 2018 Standard Specifications.

**Utilities Requiring Adjustment:**

Utility relocations are shown on the Utilities by Others Plans.

**A) South River EMC**

- 1) South River EMC will dead end the one span of their facilities nearest the bridge during construction by the date of availability. The contractor will need to communicate with the Resident Engineer once construction is complete so that the contractor
- 2) Contact person for South River EMC is Jeffrey Carroll at (919)280-2770 or at [jcarroll@sremc.com](mailto:jcarroll@sremc.com) .

**B) Star Communications**

- 1) Star Communication facilities have been abandoned in this area in the past.
- 2) Contact person for Star Communication is Joseph Andrews at (910)990-0932 or at [jandrews@stmac.net](mailto:jandrews@stmac.net) .



P.O. BOX 348, CLINTON, NORTH CAROLINA 28329  
PHONE (910) 564-4194

Felton,

Star Communications has abandoned any communication cable which would have crossed Ward Swamp at the bridge on Bradshaw Rd. All Star Communication facilities now stop before the bridge and will not be in conflict with the bridge replacement project. If you have any questions, please contact me Joseph Andrews at 910-990-0932.

Bridge project B-5310 Bradshaw Rd

Thank you,

Joseph Andrews  
Star Communications  
Plant Operations Manager

**STABILIZATION REQUIREMENTS:**

(4-30-2019)

Stabilization for this project shall comply with the time frame guidelines as specified by the NCG-010000 general construction permit effective April 1, 2019 issued by the North Carolina Department of Environmental Quality Division of Water Resources. Temporary or permanent ground cover stabilization shall occur within 7 calendar days from the last land-disturbing activity, with the following exceptions in which temporary or permanent ground cover shall be provided in 14 calendar days from the last land-disturbing activity:

- Slopes between 2:1 and 3:1, with a slope length of 10 ft. or less
- Slopes 3:1 or flatter, with a slope of length of 50 ft. or less
- Slopes 4:1 or flatter

The stabilization timeframe for High Quality Water (HQW) Zones shall be 7 calendar days with no exceptions for slope grades or lengths. High Quality Water Zones (HQW) Zones are defined by North Carolina Administrative Code 15A NCAC 04A.0105 (25). Temporary and permanent ground cover stabilization shall be achieved in accordance with the provisions in this contract and as directed.

**SEEDING AND MULCHING:**

**(East)**

The kinds of seed and fertilizer, and the rates of application of seed, fertilizer, and limestone, shall be as stated below. During periods of overlapping dates, the kind of seed to be used shall be determined. All rates are in pounds per acre.

All Roadway Areas

<b>March 1 - August 31</b>		<b>September 1 - February 28</b>	
50#	Tall Fescue	50#	Tall Fescue
10#	Centipede	10#	Centipede
25#	Bermudagrass (hulled)	35#	Bermudagrass (unhulled)
500#	Fertilizer	500#	Fertilizer
4000#	Limestone	4000#	Limestone

Waste and Borrow Locations

<b>March 1 – August 31</b>		<b>September 1 - February 28</b>	
75#	Tall Fescue	75#	Tall Fescue
25#	Bermudagrass (hulled)	35#	Bermudagrass (unhulled)
500#	Fertilizer	500#	Fertilizer
4000#	Limestone	4000#	Limestone

Note: 50# of Bahiagrass may be substituted for either Centipede or Bermudagrass only upon Engineer’s request.

Approved Tall Fescue Cultivars

06 Dust	Escalade	Justice	Serengeti
2 <sup>nd</sup> Millennium	Essential	Kalahari	Shelby Sheridan
3 <sup>rd</sup> Millennium	Evergreen 2	Kitty Hawk 2000	Sheridan
Apache III	Falcon IV	Legitimate	Signia
Avenger	Falcon NG	Lexington	Silver Hawk
Barlexas	Falcon V	LSD	Sliverstar
Barlexas II	Faith	Magellan	Shenandoah Elite
Bar Fa	Fat Cat	Matador	Sidewinder
Barrera	Festnova	Millennium SRP	Skyline
Barrington	Fidelity	Monet	Solara
Barrobusto	Finelawn Elite	Mustang 4	Southern Choice II
Barvado	Finelawn Xpress	Ninja 2	Speedway
Biltmore	Finesse II	Ol' Glory	Spyder LS
Bingo	Firebird	Olympic Gold	Sunset Gold
Bizem	Firecracker LS	Padre	Taccoa
Blackwatch	Firenza	Patagonia	Tanzania
Blade Runner II	Five Point	Pedigree	Trio
Bonsai	Focus	Picasso	Tahoe II
Braveheart	Forte	Piedmont	Talladega
Bravo	Garrison	Plantation	Tarheel
Bullseye	Gazelle II	Proseeds 5301	Terrano
Cannavaro	Gold Medallion	Prospect	Titan ltd
Catalyst	Grande 3	Pure Gold	Titanium LS
Cayenne	Greenbrooks	Quest	Tracer
Cessane Rz	Greenkeeper	Raptor II	Traverse SRP
Chipper	Gremlin	Rebel Exeda	Tulsa Time
Cochise IV	Greystone	Rebel Sentry	Turbo
Constitution	Guardian 21	Rebel IV	Turbo RZ
Corgi	Guardian 41	Regiment II	Tuxedo RZ
Corona	Hemi	Regenerate	Ultimate
Coyote	Honky Tonk	Rendition	Venture
Darlington	Hot Rod	Rhambler 2 SRP	Umbrella
Davinci	Hunter	Rembrandt	Van Gogh
Desire	Inferno	Reunion	Watchdog
Dominion	Innovator	Riverside	Wolfpack II
Dynamic	Integrity	RNP	Xtremegreen
Dynasty	Jaguar 3	Rocket	
Endeavor	Jamboree	Scorpion	

On cut and fill slopes 2:1 or steeper Centipede shall be applied at the rate of 5 pounds per acre and add 20# of Sericea Lespedeza from January 1 - December 31.



Fertilizer shall be 10-20-20 analysis. A different analysis of fertilizer may be used provided the 1-2-2 ratio is maintained and the rate of application adjusted to provide the same amount of plant food as a 10-20-20 analysis and as directed.

**TEMPORARY SEEDING:**

Fertilizer shall be the same analysis as specified for *Seeding and Mulching* and applied at the rate of 400 pounds and seeded at the rate of 50 pounds per acre. Sweet Sudan Grass, German Millet or Browntop Millet shall be used in summer months and Rye Grain during the remainder of the year. The Engineer will determine the exact dates for using each kind of seed.

**FERTILIZER TOPDRESSING:**

Fertilizer used for topdressing on all roadway areas except slopes 2:1 and steeper shall be 10-20-20 grade and shall be applied at the rate of 500 pounds per acre. A different analysis of fertilizer may be used provided the 1-2-2 ratio is maintained and the rate of application adjusted to provide the same amount of plant food as 10-20-20 analysis and as directed.

Fertilizer used for topdressing on slopes 2:1 and steeper and waste and borrow areas shall be 16-8-8 grade and shall be applied at the rate of 500 pounds per acre. A different analysis of fertilizer may be used provided the 2-1-1 ratio is maintained and the rate of application adjusted to provide the same amount of plant food as 16-8-8 analysis and as directed.

**SUPPLEMENTAL SEEDING:**

The kinds of seed and proportions shall be the same as specified for *Seeding and Mulching*, with the exception that no centipede seed will be used in the seed mix for supplemental seeding. The rate of application for supplemental seeding may vary from 25# to 75# per acre. The actual rate per acre will be determined prior to the time of topdressing and the Contractor will be notified in writing of the rate per acre, total quantity needed, and areas on which to apply the supplemental seed. Minimum tillage equipment, consisting of a sod seeder shall be used for incorporating seed into the soil as to prevent disturbance of existing vegetation. A clodbuster (ball and chain) may be used where degree of slope prevents the use of a sod seeder.

**MOWING:**

The minimum mowing height on this project shall be 4 inches.

**Native Grass Seeding and Mulching**

**(East)**

Native Grass Seeding and Mulching shall be performed on the disturbed areas of wetlands and riparian areas, and adjacent to Stream Relocation construction within a 50 foot zone on both sides of the stream or depression, measured from top of stream bank or center of depression. The stream bank of the stream relocation shall be seeded by a method that does not alter the typical cross section of the stream bank. Native Grass Seeding and Mulching shall also be

performed in the permanent soil reinforcement mat section of preformed scour holes, and in other areas as directed.

The kinds of seed and fertilizer, and the rates of application of seed, fertilizer, and limestone, shall be as stated below. During periods of overlapping dates, the kind of seed to be used shall be determined. All rates are in pounds per acre.

<b>March 1 - August 31</b>		<b>September 1 - February 28</b>	
18#	Creeping Red Fescue	18#	Creeping Red Fescue
6#	Indiangrass	6#	Indiangrass
8#	Little Bluestem	8#	Little Bluestem
4#	Switchgrass	4#	Switchgrass
25#	Browntop Millet	35#	Rye Grain
500#	Fertilizer	500#	Fertilizer
4000#	Limestone	4000#	Limestone

Approved Creeping Red Fescue Cultivars:

- Aberdeen
- Boreal
- Epic
- Cindy Lou

Fertilizer shall be 10-20-20 analysis. A different analysis of fertilizer may be used provided the 1-2-2 ratio is maintained and the rate of application adjusted to provide the same amount of plant food as a 10-20-20 analysis and as directed.

Native Grass Seeding and Mulching shall be performed in accordance with Section 1660 of the *Standard Specifications* and vegetative cover sufficient to restrain erosion shall be installed immediately following grade establishment.

**Measurement and Payment**

Native Grass *Seeding and Mulching* will be measured and paid for in accordance with Article 1660-8 of the *Standard Specifications*.

All areas seeded and mulched shall be tacked with asphalt. Crimping of straw in lieu of asphalt tack shall not be allowed on this project.

**CRIMPING STRAW MULCH:**

Crimping shall be required on this project adjacent to any section of roadway where traffic is to be maintained or allowed during construction. In areas within six feet of the edge of pavement, straw is to be applied and then crimped. After the crimping operation is complete, an additional application of straw shall be applied and immediately tacked with a sufficient amount of undiluted emulsified asphalt.

Straw mulch shall be of sufficient length and quality to withstand the crimping operation.

Crimping equipment including power source shall be subject to the approval of the Engineer providing that maximum spacing of crimper blades shall not exceed 8".

**MINIMIZE REMOVAL OF VEGETATION:**

The Contractor shall minimize removal of vegetation within project limits to the maximum extent practicable. Vegetation along stream banks and adjacent to other jurisdictional resources outside the construction limits shall only be removed upon approval of Engineer. No additional payment will be made for this minimization work.

**CONSTRUCTION MATERIALS MANAGEMENT**

(3-19-19) (rev. 04-27-20)

**Description**

The requirements set forth shall be adhered to in order to meet the applicable materials handling requirements of the NCG010000 permit. Structural controls installed to manage construction materials stored or used on site shall be shown on the E&SC Plan. Requirements for handling materials on construction sites shall be as follows:

**Polyacrylamides (PAMS) and Flocculants**

Polyacrylamides (PAMS) and flocculants shall be stored in leak-proof containers that are kept under storm-resistant cover or surrounded by secondary containment structures designed to protect adjacent surface waters. PAMS or other flocculants used shall be selected from the NC DWR List of Approved PAMS/Flocculants. The concentration of PAMS and other flocculants used shall not exceed those specified in the NC DWR List of Approved PAMS/Flocculants and in accordance with the manufacturer's instructions. The NC DWR List of Approved PAMS/Flocculants is available at:

[https://files.nc.gov/ncdeq/Water+Quality/Environmental+Sciences/ATU/PAM8\\_30\\_18.pdf](https://files.nc.gov/ncdeq/Water+Quality/Environmental+Sciences/ATU/PAM8_30_18.pdf)

**Equipment Fluids**

Fuels, lubricants, coolants, and hydraulic fluids, and other petroleum products shall be handled and disposed of in a manner so as not to enter surface or ground waters and in accordance with applicable state and federal regulations. Equipment used on the site must be operated and maintained properly to prevent discharge of fluids. Equipment, vehicle, and other wash waters shall not be discharged into E&SC basins or other E&SC devices. Alternative controls should be provided such that there is no discharge of soaps, solvents, or detergents.

**Waste Materials**

Construction materials and land clearing waste shall be disposed of in accordance with North Carolina General Statutes, Chapter 130A, Article 9 - Solid Waste Management, and rules governing the disposal of solid waste (15A NCAC 13B). Areas dedicated for managing construction material and land clearing waste shall be at least 50 feet away from storm drain inlets and surface waters unless it can be shown that no other alternatives are reasonably available. Paint and other liquid construction material waste shall not be dumped into storm drains. Paint and other liquid construction waste washouts should be located at least 50 away from storm drain inlets unless there is no alternative. Other options are to install lined washouts or use portable, removable bags or bins. Hazardous or toxic waste shall be managed in accordance with the federal Resource Conservation and Recovery Act (RCRA) and NC Hazardous Waste Rules at 15A NCAC, Subchapter 13A. Litter and sanitary waste shall be managed in a manner to prevent it from entering jurisdictional waters and shall be disposed of offsite.

**Herbicide, Pesticide, and Rodenticides**

Herbicide, pesticide, and rodenticides shall be stored and applied in accordance with the Federal Insecticide, Fungicide, and Rodenticide Act, North Carolina Pesticide Law of 1971 and labeling restrictions.

**Concrete Materials**

Concrete materials onsite, including excess concrete, must be controlled and managed to avoid contact with surface waters, wetlands or buffers. No concrete or cement slurry shall be discharged from the site. (Note that discharges from onsite concrete plants require coverage under a separate NPDES permit – NCG140000.) Concrete wash water shall be managed in accordance with the *Concrete Washout Structure* provision. Concrete slurry shall be managed and disposed of in accordance with *NCDOT DGS and HOS DCAR Distribution of Class A Residuals Statewide* (Permit No. WQ0035749). Any hardened concrete residue will be disposed of, or recycled on site, in accordance with state solid waste regulations.

**Earthen Material Stock Piles**

Earthen material stock piles shall be located at least 50 feet away from storm drain inlets and surface waters unless it can be shown that no other alternatives are reasonably available.

**Measurement and Payment**

Conditions set within the *Construction Materials Management* provision are incidental to the project for which no direct compensation will be made.

**WASTE AND BORROW SOURCES:**

(2-16-11) (Rev. 3-17-22)

Payment for temporary erosion control measures, except those made necessary by the Contractor's own negligence or for his own convenience, will be paid for at the appropriate contract unit price for the devices or measures utilized in borrow sources and waste areas.

No additional payment will be made for erosion control devices or permanent seeding and mulching in any commercial borrow or waste pit. All erosion and sediment control practices that may be required on a commercial borrow or waste site will be done at the Contractor's expense.

All offsite Staging Areas, Borrow and Waste sites shall be in accordance with "Borrow and Waste Site Reclamation Procedures for Contracted Projects" located at:

<https://connect.ncdot.gov/resources/roadside/FieldOperationsDocuments/Contract%20Reclamation%20Procedures.pdf>

All forms and documents referenced in the “Borrow and Waste Site Reclamation Procedures for Contracted Projects” shall be included with the reclamation plans for offsite staging areas, and borrow and waste sites.

### **SAFETY FENCE AND JURISDICTIONAL FLAGGING:**

#### **Description**

*Safety Fence* shall consist of furnishing materials, installing and maintaining polyethylene or polypropylene fence along the outside riparian buffer, wetland, or water boundary, or other boundaries located within the construction corridor to mark the areas that have been approved to infringe within the buffer, wetland, endangered vegetation, culturally sensitive areas or water. The fence shall be installed prior to any land disturbing activities.

Interior boundaries for jurisdictional areas noted above shall be delineated by stakes and highly visible flagging.

Jurisdictional boundaries at staging areas, waste sites, or borrow pits, whether considered outside or interior boundaries shall be delineated by stakes and highly visible flagging.

#### **Materials**

##### (A) Safety Fencing

Polyethylene or polypropylene fence shall be a highly visible preconstructed safety fence approved by the Engineer. The fence material shall have an ultraviolet coating.

Either wood posts or steel posts may be used. Wood posts shall be hardwood with a wedge or pencil tip at one end, and shall be at least 5 ft. in length with a minimum nominal 2" x 2" cross section. Steel posts shall be at least 5 ft. in length, and have a minimum weight of 0.85 lb/ft of length.

##### (B) Boundary Flagging

Wooden stakes shall be 4 feet in length with a minimum nominal 3/4" x 1-3/4" cross section. The flagging shall be at least 1" in width. The flagging material shall be vinyl and shall be orange in color and highly visible.

#### **Construction Methods**

No additional clearing and grubbing is anticipated for the installation of this fence. The fence shall be erected to conform to the general contour of the ground.

##### (A) Safety Fencing

Posts shall be set at a maximum spacing of 10 ft., maintained in a vertical position and hand set or set with a post driver. Posts shall be installed a minimum of 2 ft. into the ground. If hand set, all backfill material shall be thoroughly tamped. Wood posts may be sharpened to a dull point if power driven. Posts damaged by power driving shall be removed and replaced prior to final acceptance. The tops of all wood posts shall be cut at a 30-degree angle. The wood posts may, at the option of the Contractor, be cut at this angle either before or after the posts are erected.

The fence geotextile shall be attached to the wood posts with one 2" galvanized wire staple across each cable or to the steel posts with wire or other acceptable means.

Place construction stakes to establish the location of the safety fence in accordance with Article 105-9 or Article 801-1 of the *Standard Specifications*. No direct pay will be made for the staking of the safety fence. All stakeouts for safety fence shall be considered incidental to the work being paid for as "Construction Surveying", except that where there is no pay item for construction surveying, all safety fence stakeout will be performed by state forces.

The Contractor shall be required to maintain the safety fence in a satisfactory condition for the duration of the project as determined by the Engineer.

(B) Boundary Flagging

Boundary flagging delineation of interior boundaries shall consist of wooden stakes on 25 feet maximum intervals with highly visible orange flagging attached. Stakes shall be installed a minimum of 6" into the ground. Interior boundaries may be staked on a tangent that runs parallel to buffer but must not encroach on the buffer at any location. Interior boundaries of hand clearing shall be identified with a different colored flagging to distinguish it from mechanized clearing.

Boundary flagging delineation of interior boundaries will be placed in accordance with Article 105-9 or Article 801-1 of the *Standard Specifications*. No direct pay will be made for delineation of the interior boundaries. This delineation will be considered incidental to the work being paid for as *Construction Surveying*, except that where there is no pay item or construction surveying the cost of boundary flagging delineation shall be included in the unit prices bid for the various items in the contract. Installation for delineation of all jurisdictional boundaries at staging areas, waste sites, or borrow pits shall consist of wooden stakes on 25 feet maximum intervals with highly visible orange flagging attached. Stakes shall be installed a minimum of 6" into the ground. Additional flagging may be placed on overhanging vegetation to enhance visibility but does not substitute for installation of stakes.

Installation of boundary flagging for delineation of all jurisdictional boundaries at staging areas, waste sites, or borrow pits shall be performed in accordance with Subarticle 230-4(B)(5) or Subarticle 802-2(F) of the *Standard Specifications*. No direct pay will be made for this delineation, as the cost of same shall be included in the unit prices bid for the various items in the contract.

The Contractor shall be required to maintain alternative stakes and highly visible flagging in a satisfactory condition for the duration of the project as determined by the Engineer.

### **Measurement and Payment**

*Safety Fence* will be measured and paid as the actual number of linear feet of polyethylene or polypropylene fence installed in place and accepted. Such payment will be full compensation including but not limited to furnishing and installing fence geotextile with necessary posts and post bracing, staples, tie wires, tools, equipment and incidentals necessary to complete this work.

Payment will be made under:

<b>Pay Item</b>	<b>Pay Unit</b>
Safety Fence	Linear Foot

### **IMPERVIOUS DIKE:**

(9-9-11)(Rev. 11-15-22)

### **Description**

This work consists of furnishing, installing, maintaining, pumping and removing an *Impervious Dike* for the purpose of diverting normal stream flow around the construction site. The Contractor shall construct an impervious dike in such a manner approved by the Engineer. The impervious dike shall not permit seepage of water into the construction site or contribute to siltation of the stream. The impervious dike shall be constructed of an acceptable material in the locations noted on the plans or as directed by the Engineer.

### **Materials**

Acceptable materials shall include but not be limited to sheet piles, sandbags, and/or the placement of an acceptable size stone lined with polypropylene or other impervious geotextile.

Earth material shall not be used to construct an impervious dike when it is in direct contact with the stream unless vegetation can be established before contact with the stream takes place.

### **Construction Methods**

Where impervious dikes are shown on the plans and used to dewater or lower the water elevation, construct in accordance with Article 410-4 and 410-5.

### **Measurement and Payment**

*Impervious Dike* will be measured and paid as the actual number of linear feet of impervious dike(s) constructed, measured in place from end to end of each separate installation that has been



completed and accepted by the Engineer. Such price and payment will be full compensation for all work including but not limited to furnishing materials, construction, maintenance, pumping and removal of the impervious dike.

Payment will be made under:

<b>Pay Item</b>	<b>Pay Unit</b>
Impervious Dike	Linear Foot

### **FLOATING TURBIDITY CURTAIN:**

#### **Description**

This work consists of furnishing a *Floating Turbidity Curtain* to deter silt suspension and movement of silt particles during construction. The floating turbidity curtain shall be constructed at locations as directed.

#### **Materials**

The curtain material shall be made of a tightly woven nylon, plastic or other non-deteriorating material meeting the following specifications:

<b>Property</b>	<b>Value</b>
Grab tensile strength	*md-370 lbs *cd-250 lbs
Mullen burst strength	480 psi
Trapezoid tear strength	*md-100 lbs *cd-60 lbs
Apparent opening size	70 US standard sieve
Percent open area	4% permittivity 0.28 sec-1

\*md - machine direction

\*cd - cross machine direction

In the event that more than one width of fabric is required, a 6" overlap of the material shall also be required.

The curtain material shall be supported by a flotation material having over 29 lbs/ft buoyancy. The floating curtain shall have a 5/16" galvanized chain as ballast and dual 5/16" galvanized wire ropes with a heavy vinyl coating as load lines.

#### **Construction Methods**

The Contractor shall maintain the *Floating Turbidity Curtain* in a satisfactory condition until its removal is requested by the Engineer. The curtain shall extend to the bottom of the jurisdictional resource. Anchor the curtain according to manufacturer recommendations.

#### **Measurement and Payment**

*Floating Turbidity Curtain* will be measured and paid for as the actual number of square yards of curtain furnished as specified and accepted. Such price and payment will be full compensation for the work as described in this section including but not limited to furnishing all materials, tools, equipment, and all incidentals necessary to complete the work.

Payment will be made under:

<b>Pay Item</b>	<b>Pay Unit</b>
Floating Turbidity Curtain	Square Yard

### **CONCRETE WASHOUT STRUCTURE:**

(8-17-23)

#### **Description**

Concrete washout structures are enclosures above or below grade to contain concrete waste water and associated concrete mix from washing out ready-mix trucks, drums, pumps, or other equipment. Concrete washouts must collect and retain all the concrete washout water and solids, so that this material does not migrate to surface waters or into the ground water. These enclosures are not intended for concrete waste not associated with wash out operations.

The concrete washout structure may include constructed devices above or below ground and or commercially available devices designed specifically to capture concrete wash water.

#### **Materials**

<b>Item</b>	<b>Section</b>
Temporary Silt Fence	1605

*Safety Fence* shall meet the specifications as provided elsewhere in this contract.

Geomembrane basin liner shall meet the following minimum physical properties for low permeability; it shall consist of a polypropylene or polyethylene 10 mil think geomembrane. If the minimum setback dimensions can be achieved the liner is not required. (5 feet above groundwater, 50 feet from top of bank of perennial stream, other surface water body, or wetland.)

#### **Construction Methods**

Build an enclosed earthen berm or excavate to form an enclosure in accordance with the details and as directed.

Install temporary silt fence around the perimeter of the enclosure in accordance with the details and as directed if structure is not located in an area where existing erosion and sedimentation control devices are capable to containing any loss of sediment.

Post a sign with the words “Concrete Washout” in close proximity of the concrete washout area, so it is clearly visible to site personnel. Install safety fence as directed for visibility to construction traffic.

[Alternate details for accommodating concrete washout may be submitted for review and approval.](#)

[The alternate details shall include the method used to retain and dispose of the concrete waste water within the project limits and in accordance with the minimum setback requirements.](#) (5 feet above groundwater, 50 feet from top of bank of perennial stream, other surface water body, or wetland.)

### **Maintenance and Removal**

Maintain the concrete washout structure(s) to provide adequate holding capacity plus a minimum freeboard of 12 inches. Remove and dispose of hardened concrete and return the structure to a functional condition after reaching 75% capacity.

Inspect concrete washout structures for damage and maintain for effectiveness.

Remove the concrete washout structures and sign upon project completion. Grade the earth material to match the existing contours and permanently seed and mulch area.

### **Measurement and Payment**

*Concrete Washout Structure* will be paid for per each enclosure installed in accordance with the details. If alternate details or commercially available devices are approved, then those devices will also be paid for per each approved and installed device.

*Temporary Silt Fence* will be measured and paid for in accordance with Article 1605-5 of the *Standard Specifications*.

*Safety Fence* shall be measured and paid for as provided elsewhere in this contract. No

measurement will be made for other items or for over excavation or stockpiling.

Payment will be made under:

<b>Pay Item</b>	<b>Pay Unit</b>
Concrete Washout Structure	Each

**FABRIC INSERT INLET PROTECTION DEVICE (HIGH FLOW)**

(6-29-17)

**Description**

This work shall consist of installing, maintaining, and removing *Fabric Insert Inlet Protection Device*, of the type specified, in inlet structures (catch basins, drop inlets, etc) in areas where asphalt or concrete may prevent the proper installation of a Rock Inlet Sediment Traps Type C, or as directed.

**Materials**

The product shall be a fabric inlet protection device composed of a fitted woven polypropylene geotextile double sewn with nylon thread suspended sack. The *Fabric Insert Inlet Protection Device* shall be manufactured to fit the opening of the catch basin or drop inlet or shall have a deflector to direct runoff from the curb opening into the fabric sack. The *Fabric Insert Inlet Protection Device* shall have a rigid frame or support system to support the loaded weight of the product. The product shall have lifting loops for removing the device from the basin and will have dump straps attached at the bottom to facilitate the emptying of the device. The *Fabric Insert Inlet Protection Device* shall have an overflow system to allow stormwater to enter the inlet structure and avoid ponding on the roadway when the device reaches capacity

The stitching shall meet the following physical properties:

Physical	Test Method	English
Average Wide Width Strength	ASTM D-4884	165 lb/in

The fitted filter assembly shall have the following physical properties:

Physical	Test Method	English
Grab Tensile	ASTM D-4632	255 x 275 lbs
Minimum Puncture Strength	ASTM D-4833	125 lbs
Mullen Burst	ASTM D-3786	420 PSI
Minimum UV Resistance	ASTM D-4355	70 %.
Flow Rate	ASTM D-4491	200 gal/min/ft <sup>2</sup>
Apparent Opening	ASTM D-4751	20 US Sieve
Permittivity	ASTM D-4491	1.5 sec <sup>-1</sup>

**Construction Methods**

Strictly comply with manufacturer's installation instructions and recommendations. Maintenance shall include regular daily inspections and after each qualifying rain event. The *Fabric Insert Inlet Protection Device* shall be emptied, cleaned and placed back into the basin when it reaches 50% capacity or as directed.

**Measurement and Payment**

This work will be paid for at the contract unit price per *Fabric Insert Inlet Protection Device* of the type specified, complete in place and accepted. Such payment shall be full compensation for furnishing and installing the *Fabric Insert Inlet Protection Device* in accordance with this

specification and for all required maintenance.

Maintenance of the device, cleanout and disposal of accumulated sediments shall be paid for by *Fabric Insert Inlet Protection Device Cleanout*.

Payment will be made under:

<b>Pay Item</b>	<b>Pay Unit</b>
Fabric Insert Inlet Protection Device	Each
Fabric Insert Inlet Protection Device Cleanout	Each

# ST-1

**Project B-5310**

**Sampson County**

## Project Special Provisions

### Structures

#### Table of Contents

		<b>Page #</b>
Falsework and Formwork	(11-30-23)	ST-2
Submittal of Working Drawings	(11-30-23)	ST-8
Crane Safety	(6-20-19)	ST-14
Grout for Structures	(12-1-17)	ST-15
Asbestos Assessment	(11-30-23)	ST-16
Remnant Pile Removal	(Special)	ST-19

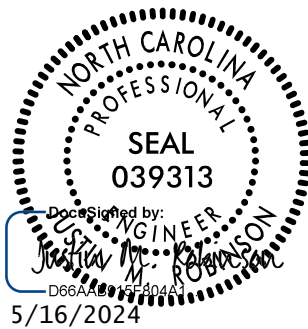

## ST-2

### **FALSEWORK AND FORMWORK**

(11-30-23)

#### **GENERAL**

Use this Special Provision as a guide to develop temporary works submittals required by the *Standard Specifications* or other provisions; no additional submittals are required herein. Such temporary works include, but are not limited to, falsework and formwork.

Falsework is any temporary construction used to support the permanent structure until it becomes self-supporting. Formwork is the temporary structure or mold used to retain plastic or fluid concrete in its designated shape until it hardens. Access scaffolding is a temporary structure that functions as a work platform that supports construction personnel, materials, and tools, but is not intended to support the structure. Scaffolding systems that are used to temporarily support permanent structures (as opposed to functioning as work platforms) are considered to be falsework under the definitions given. Shoring is a component of falsework such as horizontal, vertical, or inclined support members. Where the term “temporary works” is used, it includes all of the temporary facilities used in bridge construction that do not become part of the permanent structure.

Design and construct safe and adequate temporary works that will support all loads imposed and provide the necessary rigidity to achieve the lines and grades shown on the plans in the final structure.

#### **MATERIALS**

Select materials suitable for temporary works; however, select materials that also ensure the safety and quality required by the design assumptions. The Engineer has authority to reject material on the basis of its condition, inappropriate use, safety, or nonconformance with the plans. Clearly identify allowable loads or stresses for all materials or manufactured devices on the plans. Revise the plan and notify the Engineer if any change to materials or material strengths is required.

#### **DESIGN REQUIREMENTS**

##### **(A) Working Drawings**

Provide working drawings for items as specified in the contract, or as required by the Engineer, with design calculations and supporting data in sufficient detail to permit a structural and safety review of the proposed design of the temporary work.

On the drawings, show all information necessary to allow the design of any component to be checked independently as determined by the Engineer.

When concrete placement is involved, include data such as the drawings of proposed sequence, rate of placement, direction of placement, and location of all construction joints.

When required, have the drawings and calculations prepared under the guidance of, and sealed by, a North Carolina Registered Professional Engineer who is knowledgeable in temporary works design.

If requested by the Engineer, submit with the working drawings manufacturer’s catalog data listing the weight of all construction equipment that will be supported on the temporary

## ST-3

work. Show anticipated total settlements and/or deflections of falsework and forms on the working drawings. Include falsework footing settlements, joint take-up, and deflection of beams or girders.

As an option for the Contractor, overhang falsework hangers may be uniformly spaced, at a maximum of 36 inches, provided the following conditions are met:

Member Type (PCG)	Member Depth, (inches)	Max. Overhang Width, (inches)	Max. Slab Edge Thickness, (inches)	Max. Screenshot Wheel Weight, (lbs.)	Bracket Min. Vertical Leg Extension, (inches)
II	36	39	14	2000	26
III	45	42	14	2000	35
IV	54	45	14	2000	44
MBT	63	51	12	2000	50
MBT	72	55	12	1700	48

Overhang width is measured from the centerline of the girder to the edge of the deck slab. For Type II, III & IV prestressed concrete girders (PCG), 45-degree cast-in-place half hangers and rods must have a minimum safe working load of 6,000 lbs.

For MBT prestressed concrete girders, 45-degree angle holes for falsework hanger rods shall be cast through the girder top flange and located, measuring along the top of the member, 1'-2 1/2" from the edge of the top flange. Hanger hardware and rods must have a minimum safe working load of 6,000 lbs.

For link slabs, the top of girders directly beneath the link slab shall be free of overhang falsework attachments or other hardware. Submit calculations and working drawings for overhang falsework in the link slab region.

The overhang bracket provided for the diagonal leg shall have a minimum safe working load of 3,750 lbs. The vertical leg of the bracket shall extend to the point that the heel bears on the girder bottom flange, no closer than 4 inches from the bottom of the member. However, for 72-inch members, the heel of the bracket shall bear on the web, near the bottom flange transition.

Provide adequate overhang falsework and determine the appropriate adjustments for deck geometry, equipment, casting procedures and casting conditions.

If the optional overhang falsework spacing is used, indicate this on the falsework submittal and advise the girder producer of the proposed details. Failure to notify the Engineer of hanger type and hanger spacing on prestressed concrete girder casting drawings may delay the approval of those drawings.

Falsework hangers that support concentrated loads and are installed at the edge of thin top flange concrete girders (such as bulb tee girders) shall be spaced so as not to exceed 75% of the manufacturer's stated safe working load. Use of dual leg hangers (such as Meadow Burke



## ST-4

HF-42 and HF-43) are not allowed on concrete girders with thin top flanges. Design the falsework and forms supporting deck slabs and overhangs on girder bridges so that there will be no differential settlement between the girders and the deck forms during placement of deck concrete.

When staged construction of the bridge deck is required, detail falsework and forms for screed and fluid concrete loads to be independent of any previous deck pour components when the mid-span girder deflection due to deck weight is greater than  $\frac{3}{4}$ ".

Note on the working drawings any anchorages, connectors, inserts, steel sleeves or other such devices used as part of the falsework or formwork that remains in the permanent structure. If the plan notes indicate that the structure contains the necessary corrosion protection required for a Corrosive Site, epoxy coat, galvanize or metalize these devices. Electroplating will not be allowed. Any coating required by the Engineer will be considered incidental to the various pay items requiring temporary works.

Design falsework and formwork requiring submittals in accordance with the current edition of AASHTO Guide Design Specifications for Bridge Temporary Works except as noted herein.

### (1) Wind Loads

Table 2.2 of Article 2.2.5.1 is modified to include wind velocities up to 110 mph. In addition, Table 2.2A is included to provide the maximum wind speeds by county in North Carolina.

**Table 2.2 - Wind Pressure Values**

Height Zone feet above ground	Pressure, lb/ft <sup>2</sup> for Indicated Wind Velocity, mph				
	70	80	90	100	110
0 to 30	15	20	25	30	35
30 to 50	20	25	30	35	40
50 to 100	25	30	35	40	45
over 100	30	35	40	45	50

### (2) Time of Removal

The following requirements replace those of Article 3.4.8.2.

Do not remove forms until the concrete has attained strengths required in Article 420-16 of the Standard Specifications and these Special Provisions.

Do not remove forms until the concrete has sufficient strength to prevent surface damage.

## ST-5

**Table 2.2A - Steady State Maximum Wind Speeds by Counties in North Carolina**

COUNTY	25 YR (mph)	COUNTY	25 YR (mph)	COUNTY	25 YR (mph)
Alamance	70	Franklin	70	Pamlico	100
Alexander	70	Gaston	70	Pasquotank	100
Alleghany	70	Gates	90	Pender	100
Anson	70	Graham	80	Perquimans	100
Ashe	70	Granville	70	Person	70
Avery	70	Greene	80	Pitt	90
Beaufort	100	Guilford	70	Polk	80
Bertie	90	Halifax	80	Randolph	70
Bladen	90	Harnett	70	Richmond	70
Brunswick	100	Haywood	80	Robeson	80
Buncombe	80	Henderson	80	Rockingham	70
Burke	70	Hertford	90	Rowan	70
Cabarrus	70	Hoke	70	Rutherford	70
Caldwell	70	Hyde	110	Sampson	90
Camden	100	Iredell	70	Scotland	70
Carteret	110	Jackson	80	Stanley	70
Caswell	70	Johnston	80	Stokes	70
Catawba	70	Jones	100	Surry	70
Cherokee	80	Lee	70	Swain	80
Chatham	70	Lenoir	90	Transylvania	80
Chowan	90	Lincoln	70	Tyrell	100
Clay	80	Macon	80	Union	70
Cleveland	70	Madison	80	Vance	70
Columbus	90	Martin	90	Wake	70
Craven	100	McDowell	70	Warren	70
Cumberland	80	Mecklenburg	70	Washington	100
Currituck	100	Mitchell	70	Watauga	70
Dare	110	Montgomery	70	Wayne	80
Davidson	70	Moore	70	Wilkes	70
Davie	70	Nash	80	Wilson	80
Duplin	90	New Hanover	100	Yadkin	70
Durham	70	Northampton	80	Yancey	70
Edgecombe	80	Onslow	100		
Forsyth	70	Orange	70		

## ST-6

### (B) Review and Approval

The Engineer is responsible for the review and approval of temporary works' drawings.

Submit the working drawings sufficiently in advance of proposed use to allow for their review, revision (if needed), and approval without delay to the work.

The time period for review of the working drawings does not begin until complete drawings and design calculations, when required, are received by the Engineer.

Do not start construction of any temporary work for which working drawings are required until the drawings have been approved. Such approval does not relieve the Contractor of the responsibility for the accuracy and adequacy of the working drawings.

### CONSTRUCTION REQUIREMENTS

All requirements of Section 420 of the *Standard Specifications* apply.

Construct temporary works in conformance with the approved working drawings. Ensure that the quality of materials and workmanship employed is consistent with that assumed in the design of the temporary works. Do not weld falsework members to any portion of the permanent structure unless approved. Show any welding to the permanent structure on the approved construction drawings.

Provide tell-tales attached to the forms and extending to the ground, or other means, for accurate measurement of falsework settlement. Make sure that the anticipated compressive settlement and/or deflection of falsework does not exceed 1 inch. For cast-in-place concrete structures, make sure that the calculated deflection of falsework flexural members does not exceed 1/240 of their span regardless of whether or not the deflection is compensated by camber strips.

### (A) Maintenance and Inspection

Inspect and maintain the temporary work in an acceptable condition throughout the period of its use. Certify that the manufactured devices have been maintained in a condition to allow them to safely carry their rated loads. Clearly mark each piece so that its capacity can be readily determined at the job site.

Perform an in-depth inspection of an applicable portion(s) of the temporary works, in the presence of the Engineer, not more than 24 hours prior to the beginning of each concrete placement. Inspect other temporary works at least once a month to ensure that they are functioning properly. Have a North Carolina Registered Professional Engineer inspect the cofferdams, shoring, sheathing, support of excavation structures, and support systems for load tests prior to loading.

### (B) Foundations

Determine the safe bearing capacity of the foundation material on which the supports for temporary works rest. If required by the Engineer, conduct load tests to verify proposed bearing capacity values that are marginal or in other high-risk situations.

## ST-7

The use of the foundation support values shown on the contract plans of the permanent structure is permitted if the foundations are on the same level and on the same soil as those of the permanent structure.

Allow for adequate site drainage or soil protection to prevent soil saturation and washout of the soil supporting the temporary works supports.

If piles are used, the estimation of capacities and later confirmation during construction using standard procedures based on the driving characteristics of the pile is permitted. If preferred, use load tests to confirm the estimated capacities; or, if required by the Engineer conduct load tests to verify bearing capacity values that are marginal or in other high risk situations.

The Engineer reviews and approves the proposed pile and soil bearing capacities.

### **REMOVAL**

Unless otherwise permitted, remove and keep all temporary works upon completion of the work. Do not disturb or otherwise damage the finished work.

Remove temporary works in conformance with the contract documents. Remove them in such a manner as to permit the structure to uniformly and gradually take the stresses due to its own weight.

### **MEASUREMENT AND PAYMENT**

Unless otherwise specified, *Falsework and Formwork* will not be directly measured.

Payment at the contract unit prices for the various pay items requiring temporary works will be full compensation for the above falsework and formwork.

# ST-8

## SUBMITTAL OF WORKING DRAWINGS

(11-30-23)

### GENERAL

Submit working drawings in accordance with Article 105-2 of the *Standard Specifications* and this Special Provision. For this Special Provision, “submittals” refers to only those listed in this Special Provision. The list of submittals contained herein does not represent a list of required submittals for the project. Submittals are only necessary for those items as required by the contract. Make submittals that are not specifically noted in this provision directly to the Engineer. Either the Structures Management Unit or the Geotechnical Engineering Unit or both units will jointly review submittals.

If a submittal contains variations from plan details or specifications or significantly affects project cost, field construction or operations, discuss the submittal with and submit all copies to the Engineer. State the reason for the proposed variation in the submittal. To minimize review time, make sure all submittals are complete when initially submitted. Provide a contact name and information with each submittal. Direct any questions regarding submittal requirements to the Engineer, Structures Management Unit contacts or the Geotechnical Engineering Unit contacts noted below.

To facilitate in-plant inspection by NCDOT and approval of working drawings, provide the name, address and telephone number of the facility where fabrication will actually be done if different than shown on the title block of the submitted working drawings. This includes, but is not limited to, precast concrete items, prestressed concrete items and fabricated steel or aluminum items.

### ADDRESSES AND CONTACTS

For submittals to the Structures Management Unit, use the following addresses:

Via Email: [SMU-wdr@ncdot.gov](mailto:SMU-wdr@ncdot.gov) (do not cc SMU Working Drawings staff)

Via US mail:

Mr. B. C. Hanks, P. E.  
State Structures Engineer  
North Carolina Department  
of Transportation  
Structures Management Unit  
1581 Mail Service Center  
Raleigh, NC 27699-1581

Attention: Mr. J. L. Bolden, P. E.

Via other delivery service:

Mr. B. C. Hanks, P. E.  
State Structures Engineer  
North Carolina Department  
of Transportation  
Structures Management Unit  
1000 Birch Ridge Drive  
Raleigh, NC 27610

Attention: Mr. J. L. Bolden, P. E.

For submittals to the Geotechnical Engineering Unit, use the following addresses:

For projects in Divisions 1-7, use the following Eastern Regional Office addresses:

Via Email: [EastGeotechnicalSubmittal@ncdot.gov](mailto:EastGeotechnicalSubmittal@ncdot.gov)

## ST-9

Via US mail:

Mr. Thomas Santee, P. E.  
Assistant State Geotechnical  
Engineer – Eastern Region  
North Carolina Department  
of Transportation  
Geotechnical Engineering Unit  
Eastern Regional Office  
1570 Mail Service Center  
Raleigh, NC 27699-1570

Via other delivery service:

Mr. Thomas Santee, P. E.  
Assistant State Geotechnical  
Engineer – Eastern Region  
North Carolina Department  
of Transportation  
Geotechnical Engineering Unit  
Eastern Regional Office  
3301 Jones Sausage Road, Suite 100  
Garner, NC 27529

For projects in Divisions 8-14, use the following Western Regional Office addresses:

Via Email: [WestGeotechnicalSubmittal@ncdot.gov](mailto:WestGeotechnicalSubmittal@ncdot.gov)

Via US mail or other delivery service:

Mr. Eric Williams, P. E.  
Assistant State Geotechnical  
Engineer – Western Region  
North Carolina Department  
of Transportation  
Geotechnical Engineering Unit  
Western Regional Office  
5253 Z Max Boulevard  
Harrisburg, NC 28075

The status of the review of structure-related submittals sent to the Structures Management Unit can be viewed from the Unit's website, via the "[Drawing Submittal Status](#)" link. The status of the review of geotechnical-related submittals sent to the Geotechnical Engineering Unit can be viewed from the Unit's website, via the "[Geotechnical Construction Submittals](#)" link.

Direct any questions concerning submittal review status, review comments or drawing markups to the following contacts:

Primary Structures Contact:	James Bolden (919) 707 – 6408 <a href="mailto:jlbolden@ncdot.gov">jlbolden@ncdot.gov</a>
Secondary Structures Contacts:	Emmanuel Omile (919) 707 – 6451 <a href="mailto:emile@ncdot.gov">emile@ncdot.gov</a> Madonna Rorie (919) 707 – 6508 <a href="mailto:mrorie@ncdot.gov">mrorie@ncdot.gov</a>
Eastern Regional Geotechnical Contact (Divisions 1-7):	Thomas Santee (919) 920-8901 <a href="mailto:tgsantee@ncdot.gov">tgsantee@ncdot.gov</a>

## ST-10

Western Regional Geotechnical Contact (Divisions 8-14):

Eric Williams (704) 455 – 8902

[ewilliams3@ncdot.gov](mailto:ewilliams3@ncdot.gov)

### SUBMITTAL COPIES

Furnish one complete copy of each submittal, including all attachments, to the Engineer. At the same time, submit a copy of the same complete submittal directly to the Structures Management Unit and/or the Geotechnical Engineering Unit as specified in the tables below.

The first table below covers “Structure Submittals.” The Engineer will receive review comments and drawing markups for these submittals from the Structures Management Unit. The second table in this section covers “Geotechnical Submittals.” The Engineer will receive review comments and drawing markups for these submittals from the Geotechnical Engineering Unit.

Unless otherwise required, submit one set of supporting calculations to either the Structures Management Unit or the Geotechnical Engineering Unit unless both units require submittal copies in which case submit a set of supporting calculations to each unit. Provide additional copies of any submittal as directed.

### STRUCTURE SUBMITTALS

Submittal	Submittal Required by Structures Management Unit?	Submittal Required by Geotechnical Engineering Unit?	Contract Reference Requiring Submittal <sup>1</sup>
Arch Culvert Falsework	Y	N	Plan Note, SN Sheet & “Falsework and Formwork”
Box Culvert Falsework <sup>7</sup>	Y	N	Plan Note, SN Sheet & “Falsework and Formwork”
Cofferdams	Y	Y	Article 410-4
Foam Joint Seals <sup>6</sup>	Y	N	“Foam Joint Seals”
Expansion Joint Seals (hold down plate type with base angle)	Y	N	“Expansion Joint Seals”
Expansion Joint Seals (modular)	Y	N	“Modular Expansion Joint Seals”
Expansion Joint Seals (strip seals)	Y	N	“Strip Seal Expansion Joints”

**ST-11**

Falsework & Forms <sup>2</sup> (substructure)	Y	N	Article 420-3 & “Falsework and Formwork”
Falsework & Forms (superstructure)	Y	N	Article 420-3 & “Falsework and Formwork”
Girder Erection over Railroad	Y	N	Railroad Provisions
Maintenance and Protection of Traffic Beneath Proposed Structure	Y	N	“Maintenance and Protection of Traffic Beneath Proposed Structure at Station ____”
Metal Bridge Railing	Y	N	Plan Note
Metal Stay-in-Place Forms	Y	N	Article 420-3
Metalwork for Elastomeric Bearings <sup>4,5</sup>	Y	N	Article 1072-8
Miscellaneous Metalwork <sup>4,5</sup>	Y	N	Article 1072-8
Disc Bearings <sup>4</sup>	Y	N	“Disc Bearings”
Overhead and Digital Message Signs (DMS) (metalwork and foundations)	Y	N	Applicable Provisions
Placement of Equipment on Structures (cranes, etc.)	Y	N	Article 420-20
Prestressed Concrete Box Beam (detensioning sequences) <sup>3</sup>	Y	N	Article 1078-11
Precast Concrete Box Culverts	Y	N	“Optional Precast Reinforced Concrete Box Culvert at Station ____”
Prestressed Concrete Cored Slab (detensioning sequences) <sup>3</sup>	Y	N	Article 1078-11
Prestressed Concrete Deck Panels	Y	N	Article 420-3
Prestressed Concrete Girder (strand elongation and detensioning sequences)	Y	N	Articles 1078-8 and 1078-11
Removal of Existing Structure over Railroad	Y	N	Railroad Provisions
<hr/>			
Revised Bridge Deck Plans (adaptation to prestressed deck panels)	Y	N	Article 420-3



## ST-12

Revised Bridge Deck Plans (adaptation to modular expansion joint seals)	Y	N	“Modular Expansion Joint Seals”
Sound Barrier Wall (precast items)	Y	N	Article 1077-2 & “Sound Barrier Wall”
Sound Barrier Wall Steel Fabrication Plans <sup>5</sup>	Y	N	Article 1072-8 & “Sound Barrier Wall”
Structural Steel <sup>4</sup>	Y	N	Article 1072-8
Temporary Detour Structures	Y	Y	Article 400-3 & “Construction, Maintenance and Removal of Temporary Structure at Station _____”
TFE Expansion Bearings <sup>4</sup>	Y	N	Article 1072-8

### FOOTNOTES

1. References are provided to help locate the part of the contract where the submittals are required. References in quotes refer to the provision by that name. Articles refer to the *Standard Specifications*.
2. Submittals for these items are necessary only when required by a note on plans.
3. Submittals for these items may not be required. A list of pre-approved sequences is available from the producer or the Materials & Tests Unit.
4. The fabricator may submit these items directly to the Structures Management Unit.
5. The two sets of preliminary submittals required by Article 1072-8 of the *Standard Specifications* are not required for these items.
6. Submittals for Fabrication Drawings are not required. Submittals for Catalogue Cuts of Proposed Material are required. See Section 5.A of the referenced provision.
7. Submittals are necessary only when the top slab thickness is 18” or greater.

# ST-13

## GEOTECHNICAL SUBMITTALS

Submittal	Submittals Required by Geotechnical Engineering Unit	Submittals Required by Structures Management Unit	Contract Reference Requiring Submittal <sup>1</sup>
Drilled Pier Construction Plans <sup>2</sup>	Y	N	Subarticle 411-3(A)
Crosshole Sonic Logging (CSL) Reports <sup>2</sup>	Y	N	Subarticle 411-5(A)(2)
Pile Driving Equipment Data Forms <sup>2,3</sup>	Y	N	Subarticle 450-3(D)(2)
Pile Driving Analyzer (PDA) Reports <sup>2</sup>	Y	N	Subarticle 450-3(F)(3)
Retaining Walls <sup>4</sup>	Y; drawings and calculations	Y; drawings	Applicable Provisions
Temporary Shoring <sup>4</sup>	Y; drawings and calculations	Y; drawings	“Temporary Shoring” & “Temporary Soil Nail Walls”

### FOOTNOTES

- References are provided to help locate the part of the contract where the submittals are required. References in quotes refer to the provision by that name. Subarticles refer to the *Standard Specifications*.
- Submit one hard copy of submittal to the Engineer. Submit a second copy of submittal electronically (PDF via email), US mail or other delivery service to the appropriate Geotechnical Engineering Unit regional office. Electronic submission is preferred.
- The Pile Driving Equipment Data Form is available from:  
<https://connect.ncdot.gov/projects/construction/ConstManRefDocs/PILE%20DRIVIN%20EQUIPMENT%20DATA%20FORM.pdf>  
 See second page of form for submittal instructions.
- Electronic copy of submittal is required. See referenced provision.

# ST-14

## CRANE SAFETY

(6-20-19)

### GENERAL

Comply with the manufacturer specifications and limitations applicable to the operation of any and all cranes and derricks. Prime contractors, sub-contractors, and fully operated rental companies shall comply with the current Occupational Safety and Health Administration (OSHA) regulations.

Submit all items listed below to the Engineer prior to beginning crane operations. Changes in personnel or equipment must be reported to the Engineer and all applicable items listed below must be updated and submitted prior to continuing with crane operations.

### CRANE SAFETY SUBMITTAL LIST

- (A) **Competent Person:** Provide the name and qualifications of the “Competent Person” responsible for crane safety and lifting operations. The named competent person will have the responsibility and authority to stop any work activity due to safety concerns.
- (B) **Riggers:** Provide the qualifications and experience of the persons responsible for rigging operations. Qualifications and experience should include, but not be limited to, weight calculations, center of gravity determinations, selection and inspection of sling and rigging equipment, and safe rigging practices.
- (C) **Crane Inspections:** Inspection records for all cranes shall be current and readily accessible for review upon request.
- (D) **Certifications:** Crane operators shall be certified by the National Commission for the Certification of Crane Operators (NCCCO) or the National Center for Construction Education and Research (NCCER). Other approved nationally accredited programs will be considered upon request. In addition, crane operators shall have a current CDL medical card. Submit a list of crane operator(s) and include current certification for each type of crane operated (small hydraulic, large hydraulic, small lattice, large lattice) and medical evaluations for each operator.

### MEASUREMENT AND PAYMENT

No direct payment will be made for *Crane Safety*. All costs shall be considered incidental to items for which direct payment is made.

# ST-15

## **GROUT FOR STRUCTURES**

(12-1-17)

### **GENERAL**

This Special Provision addresses grout for use in pile blockouts, grout pockets, shear keys, dowel holes and recesses for structures. This Special Provision does not apply to grout placed in post-tensioning ducts for bridge beams, girders, decks, end bent caps, or bent caps. Mix and place grout in accordance with the manufacturer's recommendations, the applicable sections of the *Standard Specifications* and this Special Provision.

### **MATERIAL REQUIREMENT**

Unless otherwise noted on the plans, use a Type 3 Grout in accordance with Section 1003 of the *Standard Specifications*.

Initial setting time shall not be less than 10 minutes when tested in accordance with ASTM C266.

Construction loading and traffic loading shall not be allowed until the 3-day compressive strength is achieved.

### **SAMPLING AND PLACEMENT**

Place and maintain components in final position until grout placement is complete and accepted. Concrete surfaces to receive grout shall be free of defective concrete, laitance, oil, grease, and other foreign matter. Saturate concrete surfaces with clean water and remove excess water prior to placing grout.

### **MEASUREMENT AND PAYMENT**

No separate payment will be made for *Grout for Structures*. The cost of the material, equipment, labor, placement, and any incidentals necessary to complete the work shall be considered incidental to the structure item requiring grout.

# ST-16

## ASBESTOS ASSESSMENT

(11-30-23)

### **INSPECTION FOR ASBESTOS CONTAINING MATERIAL**

Prior to conducting bridge demolition or renovation activities, the Contractor shall thoroughly inspect the bridge or affected components for the presence of asbestos containing material (ACM) using a firm prequalified by NCDOT to perform asbestos surveys. The inspection must be performed by a N.C. accredited asbestos inspector with experience inspecting bridges or other industrial structures. The N.C. accredited asbestos inspector must conduct a thorough inspection, identifying all asbestos-containing material as required by the Environmental Protection Agency National Emission Standards for Hazardous Air Pollutants (NESHAP) Code of Federal Regulations (CFR) 40 CFR, Part 61, Subpart M.

The Contractor shall submit an inspection report to the Engineer, which at a minimum must include information required in 40 CFR 763.85 (a)(4) vi)(A)-(E), as well as a project location map, photos of existing structure, the date of inspection and the name, N.C. accreditation number, and signature of the N.C. accredited asbestos inspector who performed the inspection and completed the report. The cover sheet of the report shall include project identification information. Place the following notes on the cover sheet of the report and check the appropriate box:

- ACM was found  
 ACM was not found

### **REMOVAL AND DISPOSAL OF ASBESTOS CONTAINING MATERIAL**

If ACM is found, notify the Engineer. Compensation for removal and disposal of ACM is considered extra work in accordance with Article 104-7 of the *Standard Specifications*.

An Asbestos Removal Permit must be obtained from the Health Hazards Control Unit (HHCU) of the N.C. Department of Health & Human Services, Division of Public Health, if more than 35 cubic feet, 160 square feet, or 260 linear feet of regulated ACM (RACM) is to be removed from a structure and this work must be completed by a contractor prequalified by NCDOT to perform asbestos abatement. RACM is defined in 40 CFR, Part 61, Subpart M. Note: 40 CFR 763.85 (a)(4) vi)(D) defines ACM as surfacing, TSI and Miscellaneous which does not meet the NESHAP RACM.

### **DEMOLITION NOTIFICATION**

Even if no ACM is found (or if quantities are less than those required for a permit), a Demolition Notification (DHHS-3768) must be submitted to the HHCU. Notifications and Asbestos Permit applications require an original signature and must be submitted to the HHCU 10 working days prior to beginning demolition activities. The 10 working day period starts based on the post-marked date or date of hand delivery. Demolition that does not begin as originally notified requires submission of a separate revision form HHCU 3768-R to HHCU. Reference the North Carolina Administrative Code, Chapter 10A, Subchapter 41C, Article .0605 for directives on revision submissions.

### Contact Information

## ST-17

Health Hazards Control Unit (HHCU)  
N.C. Department of Health and Human Services  
1912 Mail Service Center  
Raleigh, NC 27699-1912  
Telephone: (919) 707-5950  
Fax: (919) 870-4808

### **SPECIAL CONSIDERATIONS**

Buncombe, Forsyth, and Mecklenburg counties also have asbestos permitting and NESHAP requirements must be followed. For projects involving permitted RACM removals, both the applicable county and the state (HHCU) must be notified.

For demolitions with no RACM, only the local environmental agencies must be notified. Contact information is as follows:

Buncombe County  
WNC Regional Air Pollution Control Agency  
49 Mt. Carmel Road  
Asheville, NC 28806  
(828) 250-6777

Forsyth County  
Environmental Affairs Department  
537 N. Spruce Street  
Winston-Salem, NC 27101  
(336) 703-2440

Mecklenburg County  
Land Use and Environmental Services Agency  
Mecklenburg Air Quality  
700 N. Tryon Street  
Charlotte, NC 28202  
(704) 336-5430

### **ADDITIONAL INFORMATION**

Additional information may be found on N.C. asbestos rules, regulations, procedures, and N.C. accredited inspectors, as well as associated forms for demolition notifications and asbestos permit applications at the N.C. Asbestos Hazard Management Program website:

<https://epi.dph.ncdhhs.gov/asbestos/ahmp.html>

# ST-18

## MEASUREMENT AND PAYMENT

*Asbestos Assessment* Payment will be paid at the lump sum contract unit price and will be full compensation for all asbestos inspections, reports, permitting and notifications.

Payment will be made under:

<b>Pay Item</b>	<b>Pay Unit</b>
Asbestos Assessment	Lump Sum

## ST-19

### REMNANT PILE REMOVAL

(SPECIAL)

#### DESCRIPTION

All piles from the existing bridge structure and any remnant piles from previous structures shall be removed in their entirety. If piles break off during removal or otherwise cannot be entirely removed and they do not interfere with the placement of new piles, they may be cut off one foot below the streambed.

#### MEASUREMENT AND PAYMENT

*Remnant pile removal* will be paid for under the lump sum pay item "Removal of Existing Structure at Station 17+25.50 -L-." No special payment will be included for this item.



**Certificate Of Completion**

Envelope Id: FE68DBD35E2E4FC5B2C99ADEA4040D98	Status: Completed
Subject: Complete with DocuSign: B-5310_Special Provisions.pdf	
Source Envelope:	
Document Pages: 19	Signatures: 1
Certificate Pages: 4	Initials: 0
AutoNav: Enabled	Envelope Originator:
Envelopeld Stamping: Enabled	Larissa Blankenship
Time Zone: (UTC) Dublin, Edinburgh, Lisbon, London	Mott MacDonald House
	8-10 Sydenham Road
	Croydon, Croydon CR0 2EE
	Larissa.Blankenship@mottmac.com
	IP Address: 136.226.52.202

**Record Tracking**

Status: Original	Holder: Larissa Blankenship	Location: DocuSign
5/16/2024 1:00:52 PM	Larissa.Blankenship@mottmac.com	

**Signer Events**

Justin M. Robinson  
 Justin.Robinson@mottmac.com  
 Security Level: Email, Account Authentication (None)

**Signature**



Signature Adoption: Pre-selected Style  
 Using IP Address: 136.226.52.202

**Timestamp**

Sent: 5/16/2024 1:02:53 PM  
 Viewed: 5/16/2024 1:03:13 PM  
 Signed: 5/16/2024 1:03:23 PM

**Electronic Record and Signature Disclosure:**

Accepted: 5/16/2024 1:03:13 PM  
 ID: 9ddcd679-9f04-4fdd-b178-f2674b93b686

**In Person Signer Events**

**Signature**

**Timestamp**

**Editor Delivery Events**

**Status**

**Timestamp**

**Agent Delivery Events**

**Status**

**Timestamp**

**Intermediary Delivery Events**

**Status**

**Timestamp**

**Certified Delivery Events**

**Status**

**Timestamp**

**Carbon Copy Events**

**Status**

**Timestamp**

**Witness Events**

**Signature**

**Timestamp**

**Notary Events**

**Signature**

**Timestamp**

**Envelope Summary Events**

**Status**

**Timestamps**

Envelope Sent	Hashed/Encrypted	5/16/2024 1:02:53 PM
Certified Delivered	Security Checked	5/16/2024 1:03:13 PM
Signing Complete	Security Checked	5/16/2024 1:03:23 PM
Completed	Security Checked	5/16/2024 1:03:23 PM

**Payment Events**

**Status**

**Timestamps**

**Electronic Record and Signature Disclosure**

## **ELECTRONIC RECORD AND SIGNATURE DISCLOSURE**

From time to time, Mott MacDonald - Non SAP (we, us or Company) may be required by law to provide to you certain written notices or disclosures. Described below are the terms and conditions for providing to you such notices and disclosures electronically through the DocuSign system. Please read the information below carefully and thoroughly, and if you can access this information electronically to your satisfaction and agree to this Electronic Record and Signature Disclosure (ERSD), please confirm your agreement by selecting the check-box next to 'I agree to use electronic records and signatures' before clicking 'CONTINUE' within the DocuSign system.

### **Getting paper copies**

At any time, you may request from us a paper copy of any record provided or made available electronically to you by us. You will have the ability to download and print documents we send to you through the DocuSign system during and immediately after the signing session and, if you elect to create a DocuSign account, you may access the documents for a limited period of time (usually 30 days) after such documents are first sent to you. After such time, if you wish for us to send you paper copies of any such documents from our office to you, you will be charged a \$0.00 per-page fee. You may request delivery of such paper copies from us by following the procedure described below.

### **Withdrawing your consent**

If you decide to receive notices and disclosures from us electronically, you may at any time change your mind and tell us that thereafter you want to receive required notices and disclosures only in paper format. How you must inform us of your decision to receive future notices and disclosure in paper format and withdraw your consent to receive notices and disclosures electronically is described below.

### **Consequences of changing your mind**

If you elect to receive required notices and disclosures only in paper format, it will slow the speed at which we can complete certain steps in transactions with you and delivering services to you because we will need first to send the required notices or disclosures to you in paper format, and then wait until we receive back from you your acknowledgment of your receipt of such paper notices or disclosures. Further, you will no longer be able to use the DocuSign system to receive required notices and consents electronically from us or to sign electronically documents from us.

### **All notices and disclosures will be sent to you electronically**

Unless you tell us otherwise in accordance with the procedures described herein, we will provide electronically to you through the DocuSign system all required notices, disclosures, authorizations, acknowledgements, and other documents that are required to be provided or made available to you during the course of our relationship with you. To reduce the chance of you inadvertently not receiving any notice or disclosure, we prefer to provide all of the required notices and disclosures to you by the same method and to the same address that you have given us. Thus, you can receive all the disclosures and notices electronically or in paper format through the paper mail delivery system. If you do not agree with this process, please let us know as described below. Please also see the paragraph immediately above that describes the consequences of your electing not to receive delivery of the notices and disclosures electronically from us.

### **How to contact Mott MacDonald - Non SAP:**

You may contact us to let us know of your changes as to how we may contact you electronically, to request paper copies of certain information from us, and to withdraw your prior consent to receive notices and disclosures electronically as follows:

To contact us by email send messages to: [chris.bew@mottmac.com](mailto:chris.bew@mottmac.com)

### **To advise Mott MacDonald - Non SAP of your new email address**

To let us know of a change in your email address where we should send notices and disclosures electronically to you, you must send an email message to us at [chris.bew@mottmac.com](mailto:chris.bew@mottmac.com) and in the body of such request you must state: your previous email address, your new email address. We do not require any other information from you to change your email address.

If you created a DocuSign account, you may update it with your new email address through your account preferences.

### **To request paper copies from Mott MacDonald - Non SAP**

To request delivery from us of paper copies of the notices and disclosures previously provided by us to you electronically, you must send us an email to [chris.bew@mottmac.com](mailto:chris.bew@mottmac.com) and in the body of such request you must state your email address, full name, mailing address, and telephone number. We will bill you for any fees at that time, if any.

### **To withdraw your consent with Mott MacDonald - Non SAP**

To inform us that you no longer wish to receive future notices and disclosures in electronic format you may:

- i. decline to sign a document from within your signing session, and on the subsequent page, select the check-box indicating you wish to withdraw your consent, or you may;
- ii. send us an email to [chris.bew@mottmac.com](mailto:chris.bew@mottmac.com) and in the body of such request you must state your email, full name, mailing address, and telephone number. We do not need any other information from you to withdraw consent.. The consequences of your withdrawing consent for online documents will be that transactions may take a longer time to process..

### **Required hardware and software**

The minimum system requirements for using the DocuSign system may change over time. The current system requirements are found here: <https://support.docusign.com/guides/signer-guide-signing-system-requirements>.

### **Acknowledging your access and consent to receive and sign documents electronically**

To confirm to us that you can access this information electronically, which will be similar to other electronic notices and disclosures that we will provide to you, please confirm that you have read this ERSD, and (i) that you are able to print on paper or electronically save this ERSD for your future reference and access; or (ii) that you are able to email this ERSD to an email address where you will be able to print on paper or save it for your future reference and access. Further, if you consent to receiving notices and disclosures exclusively in electronic format as described herein, then select the check-box next to ‘I agree to use electronic records and signatures’ before clicking ‘CONTINUE’ within the DocuSign system.

By selecting the check-box next to ‘I agree to use electronic records and signatures’, you confirm that:

- You can access and read this Electronic Record and Signature Disclosure; and
- You can print on paper this Electronic Record and Signature Disclosure, or save or send this Electronic Record and Disclosure to a location where you can print it, for future reference and access; and
- Until or unless you notify Mott MacDonald - Non SAP as described above, you consent to receive exclusively through electronic means all notices, disclosures, authorizations, acknowledgements, and other documents that are required to be provided or made available to you by Mott MacDonald - Non SAP during the course of your relationship with Mott MacDonald - Non SAP.

**PROJECT SPECIAL PROVISION**

(10-18-95) (Rev. 9-19-23)

Z-1

**PERMITS**

The Contractor's attention is directed to the following permits, which have been issued to the Department of Transportation by the authority granting the permit.

<b><u>PERMIT</u></b>	<b><u>AUTHORITY GRANTING THE PERMIT</u></b>
Dredge and Fill and/or Work in Navigable Waters (404)	U. S. Army Corps of Engineers
Water Quality (401)	Division of Environmental Management, DEQ State of North Carolina

The Contractor shall comply with all applicable permit conditions during construction of this project.

Agents of the permitting authority will periodically inspect the project for adherence to the permits.

The Contractor's attention is also directed to Articles 107-10 and 107-13 of the *Standard Specifications* and the following:

Should the Contractor propose to utilize construction methods (such as temporary structures or fill in waters and/or wetlands for haul roads, work platforms, cofferdams, etc.) not specifically identified in the permit (individual, general, or nationwide) authorizing the project it shall be the Contractor's responsibility to coordinate with the Engineer to determine what, if any, additional permit action is required. The Contractor shall also be responsible for initiating the request for the authorization of such construction method by the permitting agency. The request shall be submitted through the Engineer. The Contractor shall not utilize the construction method until it is approved by the permitting agency. The request normally takes approximately 60 days to process; however, no extensions of time or additional compensation will be granted for delays resulting from the Contractor's request for approval of construction methods not specifically identified in the permit.

**Where construction moratoriums are contained in a permit condition which restricts the Contractor's activities to certain times of the year, those moratoriums will apply only to the portions of the work taking place in the restricted waters, wetlands or buffer zones, provided that activities outside those areas is done in such a manner as to not affect the restricted waters, wetlands or buffer zones.**



STATE OF NORTH CAROLINA  
DEPARTMENT OF TRANSPORTATION

ROY COOPER  
GOVERNOR

J. ERIC BOYETTE  
SECRETARY

June 5, 2023

MEMO TO: Derek Pielech, PE  
Division Bridge Program Engineer

FROM: Mason Herndon  
Division PDEA Engineer

SUBJECT: Sampson County; Bridge No. 188 over Ward Swamp on SR 1817  
(Bradshaw Road); FA Project No. BRZ-1817(001); WBS No.  
46024.1.2; **TIP No. B-5310**

Please find attached the following permits for the subject project:

Agency	Permit Type	Permit Expiration
US Army Corps of Engineers Section 404 Clean Water Act Permit	Nationwide Permit 3	March 14, 2026
NC Division of Water Resources Section 401 Water Quality Certification	General Certification No. 4239	March 14, 2026

If you have any questions or if I can be of any further assistance, please do not hesitate to contact me.

cc: w/attachment

David Leonard, P.E. Division Project Team Lead  
Eric Murray, Assistant Bridge Program Manager  
Jonathan Mitchell, Division Contract & Proposals Engineer  
Jon Giles, Division Environmental Officer  
Eric Matuszewski, Division Utility Coordinator

Mailing Address:  
NC DEPARTMENT OF TRANSPORTATION  
DIVISION OF HIGHWAYS  
5501 BARBADOS BOULEVARD  
CASTLE HAYNE, NC 28429-5647

Telephone: 910-341-2000  
Fax: 910-675-0143  
Customer Service: 1-877-368-4968

Website: [ncdot.gov](http://ncdot.gov)

Location:  
5501 BARBADOS BOULEVARD  
CASTLE HAYNE, NC 28429-5647

# NCDOT PROJECT COMMITMENTS

STIP Project No. B-5310  
Replace Bridge No. 188 over Ward Swamp on SR 1817 (Bradshaw Road)  
Sampson County  
Federal Aid Project No. BRZ-1817(001)  
WBS Element **46024.1.2**

## **Division 3 Construction - Offsite Detour**

Sampson County School Transportation will be contacted at (910) 592-3191 and Sampson County Emergency Management will be contacted at (910) 592-8996 at least one month prior to bridge closure to make necessary temporary reassignments.

## **Hydraulics Unit - FEMA Coordination**

The Hydraulics Unit will coordinate with the N.C. Floodplain Mapping Program (FMP) to determine the status of the project regarding applicability of NCDOT's Memorandum of Agreement, or approval of a Conditional Letter of Map Revision (CLOMR) and subsequent final Letter of Map Revision (LOMR). *(Commitment addressed during design)*

## **Hydraulics Unit / Division 3 Construction - FEMA - As-Built Construction Plans**

This project involves construction on or adjacent to a FEMA-regulated stream. To meet FEMA compliance, certified As-Built plans must be submitted to FEMA within six months of structure completion. Therefore, the Division Resident Engineer shall submit sealed as-built construction plans to the Hydraulics Unit upon completion of project construction. Electronic submittal is preferred and may be sent to the following email address: [NCDOT\\_Hydraulics\\_As-Built\\_Plans@ncdot.gov](mailto:NCDOT_Hydraulics_As-Built_Plans@ncdot.gov).

## **Division 3 Environmental Unit - Wood Stork Survey**

A survey for wood stork was conducted on June 10, 2021 and no wood storks, nests, or roosts were observed. This project falls within the PBE parameters for the wood stork with a biological conclusion of **May Affect, Not Likely to Adversely Affect**. The NCDOT Division Environmental Unit will resurvey for the wood stork two years prior to permitting. *(Commitment completed on 5/1/23).*

## **Division 3 Construction - Detour Route**

Project BP3-R009 (Sampson 194) is being replaced and SR 1817 (Bradshaw Road) is part of that project's detour route. The LET date for Project BP3-R009 is 07/2020 with an assumed detour schedule of 284 days. The LET dates between Project BP3-R009 and B-5310 should be coordinated. *(Commitment addressed in planning)*

**Nationwide Permit 3**  
**Maintenance**

Effective Date: February 25, 2022 / Expiration Date: March 14, 2026  
Authority: Sections 10 and 404

(a) The repair, rehabilitation, or replacement of any previously authorized, currently serviceable structure or fill, or of any currently serviceable structure or fill authorized by 33 CFR 330.3, provided that the structure or fill is not to be put to uses differing from those uses specified or contemplated for it in the original permit or the most recently authorized modification. Minor deviations in the structure's configuration or filled area, including those due to changes in materials, construction techniques, requirements of other regulatory agencies, or current construction codes or safety standards that are necessary to make the repair, rehabilitation, or replacement are authorized. This NWP also authorizes the removal of previously authorized structures or fills. Any stream channel modification is limited to the minimum necessary for the repair, rehabilitation, or replacement of the structure or fill; such modifications, including the removal of material from the stream channel, must be immediately adjacent to the project. This NWP also authorizes the removal of accumulated sediment and debris within, and in the immediate vicinity of, the structure or fill. This NWP also authorizes the repair, rehabilitation, or replacement of those structures or fills destroyed or damaged by storms, floods, fire or other discrete events, provided the repair, rehabilitation, or replacement is commenced, or is under contract to commence, within two years of the date of their destruction or damage. In cases of catastrophic events, such as hurricanes or tornadoes, this two-year limit may be waived by the district engineer, provided the permittee can demonstrate funding, contract, or other similar delays.

(b) This NWP also authorizes the removal of accumulated sediments and debris outside the immediate vicinity of existing structures (e.g., bridges, culverted road crossings, water intake structures, etc.). The removal of sediment is limited to the minimum necessary to restore the waterway in the vicinity of the structure to the approximate dimensions that existed when the structure was built but cannot extend farther than 200 feet in any direction from the structure. This 200-foot limit does not apply to maintenance dredging to remove accumulated sediments blocking or restricting outfall and intake structures or to maintenance dredging to remove accumulated sediments from canals associated with outfall and intake structures. All dredged or excavated materials must be deposited and retained in an area that has no waters of the United States unless otherwise specifically approved by the district engineer under separate authorization.

(c) This NWP also authorizes temporary structures, fills, and work, including the use of temporary mats, necessary to conduct the maintenance activity. Appropriate measures must be taken to maintain normal downstream flows and minimize flooding to the maximum extent practicable, when temporary structures, work, and discharges of dredged or fill material, including cofferdams, are necessary for construction activities, access fills, or dewatering of construction sites. Temporary fills must consist of materials, and be placed in a manner, that will not be eroded by expected high flows. After conducting the maintenance activity, temporary fills must be removed in their entirety and the affected areas returned to pre-construction elevations. The areas affected by temporary fills must be revegetated, as appropriate.

(d) This NWP does not authorize maintenance dredging for the primary purpose of navigation. This NWP does not authorize beach restoration. This NWP does not authorize new stream channelization or stream relocation projects.



**Notification:** For activities authorized by paragraph (b) of this NWP, the permittee must submit a pre-construction notification to the district engineer prior to commencing the activity (see general condition 32). The pre-construction notification must include information regarding the original design capacities and configurations of the outfalls, intakes, small impoundments, and canals. (Authorities: Section 10 of the Rivers and Harbors Act of 1899 and Section 404 of the Clean Water Act (Sections 10 and 404))

**Note:** This NWP authorizes the repair, rehabilitation, or replacement of any previously authorized structure or fill that does not qualify for the Clean Water Act Section 404(f) exemption for maintenance.

## **GENERAL CONDITIONS**

Note: To qualify for NWP authorization, the prospective permittee must comply with the following general conditions, as applicable, in addition to any regional or case-specific conditions imposed by the division engineer or district engineer. Prospective permittees should contact the appropriate Corps district office to determine if regional conditions have been imposed on an NWP. Prospective permittees should also contact the appropriate Corps district office to determine the status of Clean Water Act Section 401 water quality certification and/or Coastal Zone Management Act consistency for an NWP. Every person who may wish to obtain permit authorization under one or more NWPs, or who is currently relying on an existing or prior permit authorization under one or more NWPs, has been and is on notice that all of the provisions of 33 CFR 330.1 through 330.6 apply to every NWP authorization. Note especially 33 CFR 330.5 relating to the modification, suspension, or revocation of any NWP authorization.

### **1. Navigation.**

(a) No activity may cause more than a minimal adverse effect on navigation.

(b) Any safety lights and signals prescribed by the U.S. Coast Guard, through regulations or otherwise, must be installed and maintained at the permittee's expense on authorized facilities in navigable waters of the United States.

(c) The permittee understands and agrees that, if future operations by the United States require the removal, relocation, or other alteration, of the structure or work herein authorized, or if, in the opinion of the Secretary of the Army or his authorized representative, said structure or work shall cause unreasonable obstruction to the free navigation of the navigable waters, the permittee will be required, upon due notice from the Corps of Engineers, to remove, relocate, or alter the structural work or obstructions caused thereby, without expense to the United States. No claim shall be made against the United States on account of any such removal or alteration.

**2. Aquatic Life Movements.** No activity may substantially disrupt the necessary life cycle movements of those species of aquatic life indigenous to the waterbody, including those species that normally migrate through the area, unless the activity's primary purpose is to impound water. All permanent and temporary crossings of waterbodies shall be suitably culverted, bridged, or otherwise designed and constructed to maintain low flows to sustain the movement of those aquatic species. If a bottomless culvert cannot be used, then the crossing should be designed and constructed to minimize adverse effects to aquatic life movements.

3. **Spawning Areas.** Activities in spawning areas during spawning seasons must be avoided to the maximum extent practicable. Activities that result in the physical destruction (e.g., through excavation, fill, or downstream smothering by substantial turbidity) of an important spawning area are not authorized.
4. **Migratory Bird Breeding Areas.** Activities in waters of the United States that serve as breeding areas for migratory birds must be avoided to the maximum extent practicable.
5. **Shellfish Beds.** No activity may occur in areas of concentrated shellfish populations, unless the activity is directly related to a shellfish harvesting activity authorized by NWP 4 and 48, or is a shellfish seeding or habitat restoration activity authorized by NWP 27.
6. **Suitable Material.** No activity may use unsuitable material (e.g., trash, debris, car bodies, asphalt, etc.). Material used for construction or discharged must be free from toxic pollutants in toxic amounts (see section 307 of the Clean Water Act).
7. **Water Supply Intakes.** No activity may occur in the proximity of a public water supply intake, except where the activity is for the repair or improvement of public water supply intake structures or adjacent bank stabilization.
8. **Adverse Effects from Impoundments.** If the activity creates an impoundment of water, adverse effects to the aquatic system due to accelerating the passage of water, and/or restricting its flow must be minimized to the maximum extent practicable.
9. **Management of Water Flows.** To the maximum extent practicable, the pre-construction course, condition, capacity, and location of open waters must be maintained for each activity, including stream channelization, storm water management activities, and temporary and permanent road crossings, except as provided below. The activity must be constructed to withstand expected high flows. The activity must not restrict or impede the passage of normal or high flows unless the primary purpose of the activity is to impound water or manage high flows. The activity may alter the pre-construction course, condition, capacity, and location of open waters if it benefits the aquatic environment (e.g., stream restoration or relocation activities).
10. **Fills Within 100-Year Floodplains.** The activity must comply with applicable FEMA-approved state or local floodplain management requirements.
11. **Equipment.** Heavy equipment working in wetlands or mudflats must be placed on mats, or other measures must be taken to minimize soil disturbance.
12. **Soil Erosion and Sediment Controls.** Appropriate soil erosion and sediment controls must be used and maintained in effective operating condition during construction, and all exposed soil and other fills, as well as any work below the ordinary high water mark or high tide line, must be permanently stabilized at the earliest practicable date. Permittees are encouraged to perform work within waters of the United States during periods of low-flow or no-flow, or during low tides.
13. **Removal of Structures and Fills.** Temporary structures must be removed, to the maximum extent practicable, after their use has been discontinued. Temporary fills must be removed in their entirety and the affected areas returned to pre-construction elevations. The affected areas must be revegetated, as appropriate.

14. **Proper Maintenance.** Any authorized structure or fill shall be properly maintained, including maintenance to ensure public safety and compliance with applicable NWP general conditions, as well as any activity-specific conditions added by the district engineer to an NWP authorization.

15. **Single and Complete Project.** The activity must be a single and complete project. The same NWP cannot be used more than once for the same single and complete project.

16. **Wild and Scenic Rivers.**

(a) No NWP activity may occur in a component of the National Wild and Scenic River System, or in a river officially designated by Congress as a “study river” for possible inclusion in the system while the river is in an official study status, unless the appropriate Federal agency with direct management responsibility for such river, has determined in writing that the proposed activity will not adversely affect the Wild and Scenic River designation or study status.

(b) If a proposed NWP activity will occur in a component of the National Wild and Scenic River System, or in a river officially designated by Congress as a “study river” for possible inclusion in the system while the river is in an official study status, the permittee must submit a pre-construction notification (see general condition 32). The district engineer will coordinate the PCN with the Federal agency with direct management responsibility for that river. Permittees shall not begin the NWP activity until notified by the district engineer that the Federal agency with direct management responsibility for that river has determined in writing that the proposed NWP activity will not adversely affect the Wild and Scenic River designation or study status.

(c) Information on Wild and Scenic Rivers may be obtained from the appropriate Federal land management agency responsible for the designated Wild and Scenic River or study river (e.g., National Park Service, U.S. Forest Service, Bureau of Land Management, U.S. Fish and Wildlife Service). Information on these rivers is also available at: <http://www.rivers.gov/>.

17. **Tribal Rights.** No activity or its operation may impair reserved tribal rights, including, but not limited to, reserved water rights and treaty fishing and hunting rights.

18. **Endangered Species.**

(a) No activity is authorized under any NWP which is likely to directly or indirectly jeopardize the continued existence of a threatened or endangered species or a species proposed for such designation, as identified under the Federal Endangered Species Act (ESA), or which will directly or indirectly destroy or adversely modify the critical habitat of such species. No activity is authorized under any NWP which “may affect” a listed species or critical habitat unless ESA section 7 consultation addressing the consequences of the proposed activity on listed species or critical habitat has been completed. See 50 CFR 402.02 for the definition of “effects of the action” for the purposes of ESA section 7 consultation, as well as 50 CFR 402.17, which provides further explanation under ESA section 7 regarding “activities that are reasonably certain to occur” and “consequences caused by the proposed action.”

(b) Federal agencies should follow their own procedures for complying with the requirements of the ESA (see 33 CFR 330.4(f)(1)). If pre-construction notification is required for the proposed activity, the Federal permittee must provide the district engineer with the appropriate documentation to demonstrate compliance with those requirements. The district engineer will verify that the appropriate documentation has been submitted. If the appropriate documentation has not been submitted, additional ESA section 7 consultation may be

necessary for the activity and the respective federal agency would be responsible for fulfilling its obligation under section 7 of the ESA.

(c) Non-federal permittees must submit a pre-construction notification to the district engineer if any listed species or designated critical habitat might be affected or is in the vicinity of the activity, or if the activity is located in designated critical habitat, and shall not begin work on the activity until notified by the district engineer that the requirements of the ESA have been satisfied and that the activity is authorized. For activities that might affect Federally-listed endangered or threatened species or designated critical habitat, the pre-construction notification must include the name(s) of the endangered or threatened species that might be affected by the proposed activity or that utilize the designated critical habitat that might be affected by the proposed activity. The district engineer will determine whether the proposed activity “may affect” or will have “no effect” to listed species and designated critical habitat and will notify the non-Federal applicant of the Corps’ determination within 45 days of receipt of a complete pre-construction notification. For activities where the non-Federal applicant has identified listed species or critical habitat that might be affected or is in the vicinity of the activity, and has so notified the Corps, the applicant shall not begin work until the Corps has provided notification that the proposed activity will have “no effect” on listed species or critical habitat, or until ESA section 7 consultation has been completed. If the non-Federal applicant has not heard back from the Corps within 45 days, the applicant must still wait for notification from the Corps.

(d) As a result of formal or informal consultation with the FWS or NMFS the district engineer may add species specific permit conditions to the NWP.

(e) Authorization of an activity by an NWP does not authorize the “take” of a threatened or endangered species as defined under the ESA. In the absence of separate authorization (e.g., an ESA Section 10 Permit, a Biological Opinion with “incidental take” provisions, etc.) from the FWS or the NMFS, the Endangered Species Act prohibits any person subject to the jurisdiction of the United States to take a listed species, where “take” means to harass, harm, pursue, hunt, shoot, wound, kill, trap, capture, or collect, or to attempt to engage in any such conduct. The word “harm” in the definition of “take” means an act which actually kills or injures wildlife. Such an act may include significant habitat modification or degradation where it actually kills or injures wildlife by significantly impairing essential behavioral patterns, including breeding, feeding or sheltering.

(f) If the non-federal permittee has a valid ESA section 10(a)(1)(B) incidental take permit with an approved Habitat Conservation Plan for a project or a group of projects that includes the proposed NWP activity, the non-federal applicant should provide a copy of that ESA section 10(a)(1)(B) permit with the PCN required by paragraph (c) of this general condition. The district engineer will coordinate with the agency that issued the ESA section 10(a)(1)(B) permit to determine whether the proposed NWP activity and the associated incidental take were considered in the internal ESA section 7 consultation conducted for the ESA section 10(a)(1)(B) permit. If that coordination results in concurrence from the agency that the proposed NWP activity and the associated incidental take were considered in the internal ESA section 7 consultation for the ESA section 10(a)(1)(B) permit, the district engineer does not need to conduct a separate ESA section 7 consultation for the proposed NWP activity. The district engineer will notify the non-federal applicant within 45 days of receipt of a complete pre-construction notification whether the ESA section 10(a)(1)(B) permit covers the proposed NWP activity or whether additional ESA section 7 consultation is required.

(g) Information on the location of threatened and endangered species and their critical habitat can be obtained directly from the offices of the FWS and NMFS or their worldwide Web pages at <http://www.fws.gov/> or <http://www.fws.gov/ipac> and <http://www.nmfs.noaa.gov/pr/species/esa/> respectively.

19. **Migratory Birds and Bald and Golden Eagles**. The permittee is responsible for ensuring that an action authorized by NWP complies with the Migratory Bird Treaty Act and the Bald and Golden Eagle Protection Act. The permittee is responsible for contacting the appropriate local office of the U.S. Fish and Wildlife Service to determine what measures, if any, are necessary or appropriate to reduce adverse effects to migratory birds or eagles, including whether "incidental take" permits are necessary and available under the Migratory Bird Treaty Act or Bald and Golden Eagle Protection Act for a particular activity.

20. **Historic Properties**.

(a) No activity is authorized under any NWP which may have the potential to cause effects to properties listed, or eligible for listing, in the National Register of Historic Places until the requirements of Section 106 of the National Historic Preservation Act (NHPA) have been satisfied.

(b) Federal permittees should follow their own procedures for complying with the requirements of section 106 of the National Historic Preservation Act (see 33 CFR 330.4(g)(1)). If pre-construction notification is required for the proposed NWP activity, the Federal permittee must provide the district engineer with the appropriate documentation to demonstrate compliance with those requirements. The district engineer will verify that the appropriate documentation has been submitted. If the appropriate documentation is not submitted, then additional consultation under section 106 may be necessary. The respective federal agency is responsible for fulfilling its obligation to comply with section 106.

(c) Non-federal permittees must submit a pre-construction notification to the district engineer if the NWP activity might have the potential to cause effects to any historic properties listed on, determined to be eligible for listing on, or potentially eligible for listing on the National Register of Historic Places, including previously unidentified properties. For such activities, the pre-construction notification must state which historic properties might have the potential to be affected by the proposed NWP activity or include a vicinity map indicating the location of the historic properties or the potential for the presence of historic properties. Assistance regarding information on the location of, or potential for, the presence of historic properties can be sought from the State Historic Preservation Officer, Tribal Historic Preservation Officer, or designated tribal representative, as appropriate, and the National Register of Historic Places (see 33 CFR 330.4(g)). When reviewing pre-construction notifications, district engineers will comply with the current procedures for addressing the requirements of section 106 of the National Historic Preservation Act. The district engineer shall make a reasonable and good faith effort to carry out appropriate identification efforts commensurate with potential impacts, which may include background research, consultation, oral history interviews, sample field investigation, and/or field survey. Based on the information submitted in the PCN and these identification efforts, the district engineer shall determine whether the proposed NWP activity has the potential to cause effects on the historic properties. Section 106 consultation is not required when the district engineer determines that the activity does not have the potential to cause effects on historic properties (see 36 CFR 800.3(a)). Section 106 consultation is required when the district engineer determines that the activity has the potential to cause effects on historic properties. The district engineer will conduct consultation with consulting parties identified under 36 CFR

800.2(c) when he or she makes any of the following effect determinations for the purposes of section 106 of the NHPA: no historic properties affected, no adverse effect, or adverse effect.

(d) Where the non-Federal applicant has identified historic properties on which the proposed NWP activity might have the potential to cause effects and has so notified the Corps, the non-Federal applicant shall not begin the activity until notified by the district engineer either that the activity has no potential to cause effects to historic properties or that NHPA section 106 consultation has been completed. For non-federal permittees, the district engineer will notify the prospective permittee within 45 days of receipt of a complete pre-construction notification whether NHPA section 106 consultation is required. If NHPA section 106 consultation is required, the district engineer will notify the non-Federal applicant that he or she cannot begin the activity until section 106 consultation is completed. If the non-Federal applicant has not heard back from the Corps within 45 days, the applicant must still wait for notification from the Corps.

(e) Prospective permittees should be aware that section 110k of the NHPA (54 U.S.C. 306113) prevents the Corps from granting a permit or other assistance to an applicant who, with intent to avoid the requirements of section 106 of the NHPA, has intentionally significantly adversely affected a historic property to which the permit would relate, or having legal power to prevent it, allowed such significant adverse effect to occur, unless the Corps, after consultation with the Advisory Council on Historic Preservation (ACHP), determines that circumstances justify granting such assistance despite the adverse effect created or permitted by the applicant. If circumstances justify granting the assistance, the Corps is required to notify the ACHP and provide documentation specifying the circumstances, the degree of damage to the integrity of any historic properties affected, and proposed mitigation. This documentation must include any views obtained from the applicant, SHPO/THPO, appropriate Indian tribes if the undertaking occurs on or affects historic properties on tribal lands or affects properties of interest to those tribes, and other parties known to have a legitimate interest in the impacts to the permitted activity on historic properties.

21. **Discovery of Previously Unknown Remains and Artifacts.** Permittees that discover any previously unknown historic, cultural or archeological remains and artifacts while accomplishing the activity authorized by NWP, they must immediately notify the district engineer of what they have found, and to the maximum extent practicable, avoid construction activities that may affect the remains and artifacts until the required coordination has been completed. The district engineer will initiate the Federal, Tribal, and state coordination required to determine if the items or remains warrant a recovery effort or if the site is eligible for listing in the National Register of Historic Places.

22. **Designated Critical Resource Waters.** Critical resource waters include, NOAA-managed marine sanctuaries and marine monuments, and National Estuarine Research Reserves. The district engineer may designate, after notice and opportunity for public comment, additional waters officially designated by a state as having particular environmental or ecological significance, such as outstanding national resource waters or state natural heritage sites. The district engineer may also designate additional critical resource waters after notice and opportunity for public comment.

(a) Discharges of dredged or fill material into waters of the United States are not authorized by NWPs 7, 12, 14, 16, 17, 21, 29, 31, 35, 39, 40, 42, 43, 44, 49, 50, 51, 52, 57 and 5258 for any activity within, or directly affecting, critical resource waters, including wetlands adjacent to such waters.

(b) For NWP 3, 8, 10, 13, 15, 18, 19, 22, 23, 25, 27, 28, 30, 33, 34, 36, 37, 38, and 54, notification is required in accordance with general condition 32, for any activity proposed by permittees in the designated critical resource waters including wetlands adjacent to those waters. The district engineer may authorize activities under these NWPs only after she or he determines that the impacts to the critical resource waters will be no more than minimal.

23. **Mitigation.** The district engineer will consider the following factors when determining appropriate and practicable mitigation necessary to ensure that the individual and cumulative adverse environmental effects are no more than minimal:

(a) The activity must be designed and constructed to avoid and minimize adverse effects, both temporary and permanent, to waters of the United States to the maximum extent practicable at the project site (*i.e.*, on site).

(b) Mitigation in all its forms (avoiding, minimizing, rectifying, reducing, or compensating for resource losses) will be required to the extent necessary to ensure that the individual and cumulative adverse environmental effects are no more than minimal.

(c) Compensatory mitigation at a minimum one-for-one ratio will be required for all wetland losses that exceed 1/10-acre and require pre-construction notification, unless the district engineer determines in writing that either some other form of mitigation would be more environmentally appropriate or the adverse environmental effects of the proposed activity are no more than minimal, and provides an activity-specific waiver of this requirement. For wetland losses of 1/10-acre or less that require pre-construction notification, the district engineer may determine on a case-by-case basis that compensatory mitigation is required to ensure that the activity results in only minimal adverse environmental effects.

(d) Compensatory mitigation at a minimum one-for-one ratio will be required for all losses of stream bed that exceed 1/103/100-acre and require pre-construction notification, unless the district engineer determines in writing that either some other form of mitigation would be more environmentally appropriate or the adverse environmental effects of the proposed activity are no more than minimal, and provides an activity-specific waiver of this requirement. This compensatory mitigation requirement may be satisfied through the restoration or enhancement of riparian areas next to streams in accordance with paragraph (e) of this general condition. For losses of stream bed of 1/103/100-acre or less that require pre-construction notification, the district engineer may determine on a case-by-case basis that compensatory mitigation is required to ensure that the activity results in only minimal adverse environmental effects. Compensatory mitigation for losses of streams should be provided, if practicable, through stream rehabilitation, enhancement, or preservation since streams are difficult-to-replace resources (see 33 CFR 332.3(e)(3)).

(e) Compensatory mitigation plans for NWP activities in or near streams or other open waters will normally include a requirement for the restoration or enhancement, maintenance, and legal protection (e.g., conservation easements) of riparian areas next to open waters. In some cases, the restoration or maintenance/protection of riparian areas may be the only compensatory mitigation required. If restoring riparian areas involves planting vegetation, only native species should be planted. The width of the required riparian area will address documented water quality or aquatic habitat loss concerns. Normally, the riparian area will be 25 to 50 feet wide on each side of the stream, but the district engineer may require slightly wider riparian areas to address documented water quality or habitat loss concerns. If it is not possible to restore or maintain/protect a riparian area on both sides of a stream, or if the

waterbody is a lake or coastal waters, then restoring or maintaining/protecting a riparian area along a single bank or shoreline may be sufficient. Where both wetlands and open waters exist on the project site, the district engineer will determine the appropriate compensatory mitigation (e.g., riparian areas and/or wetlands compensation) based on what is best for the aquatic environment on a watershed basis. In cases where riparian areas are determined to be the most appropriate form of minimization or compensatory mitigation, the district engineer may waive or reduce the requirement to provide wetland compensatory mitigation for wetland losses.

(f) Compensatory mitigation projects provided to offset losses of aquatic resources must comply with the applicable provisions of 33 CFR part 332.

(1) The prospective permittee is responsible for proposing an appropriate compensatory mitigation option if compensatory mitigation is necessary to ensure that the activity results in no more than minimal adverse environmental effects. For the NWP, the preferred mechanism for providing compensatory mitigation is mitigation bank credits or in-lieu fee program credits (see 33 CFR 332.3(b)(2) and (3)). However, if an appropriate number and type of mitigation bank or in-lieu credits are not available at the time the PCN is submitted to the district engineer, the district engineer may approve the use of permittee-responsible mitigation.

(2) The amount of compensatory mitigation required by the district engineer must be sufficient to ensure that the authorized activity results in no more than minimal individual and cumulative adverse environmental effects (see 33 CFR 330.1(e)(3)). (See also 33 CFR 332.3(f)).

(3) Since the likelihood of success is greater and the impacts to potentially valuable uplands are reduced, aquatic resource restoration should be the first compensatory mitigation option considered for permittee-responsible mitigation.

(4) If permittee-responsible mitigation is the proposed option, the prospective permittee is responsible for submitting a mitigation plan. A conceptual or detailed mitigation plan may be used by the district engineer to make the decision on the NWP verification request, but a final mitigation plan that addresses the applicable requirements of 33 CFR 332.4(c)(2) through (14) must be approved by the district engineer before the permittee begins work in waters of the United States, unless the district engineer determines that prior approval of the final mitigation plan is not practicable or not necessary to ensure timely completion of the required compensatory mitigation (see 33 CFR 332.3(k)(3)). If permittee-responsible mitigation is the proposed option, and the proposed compensatory mitigation site is located on land in which another federal agency holds an easement, the district engineer will coordinate with that federal agency to determine if proposed compensatory mitigation project is compatible with the terms of the easement.

(5) If mitigation bank or in-lieu fee program credits are the proposed option, the mitigation plan needs to address only the baseline conditions at the impact site and the number of credits to be provided (see 33 CFR 332.4(c)(1)(ii)).

(6) Compensatory mitigation requirements (e.g., resource type and amount to be provided as compensatory mitigation, site protection, ecological performance standards, monitoring requirements) may be addressed through conditions added to the NWP authorization, instead of components of a compensatory mitigation plan (see 33 CFR 332.4(c)(1)(ii)).



(g) Compensatory mitigation will not be used to increase the acreage losses allowed by the acreage limits of the NWP. For example, if an NWP has an acreage limit of 1/2-acre, it cannot be used to authorize any NWP activity resulting in the loss of greater than 1/2-acre of waters of the United States, even if compensatory mitigation is provided that replaces or restores some of the lost waters. However, compensatory mitigation can and should be used, as necessary, to ensure that an NWP activity already meeting the established acreage limits also satisfies the no more than minimal impact requirement for the NWPs.

(h) Permittees may propose the use of mitigation banks, in-lieu fee programs, or permittee-responsible mitigation. When developing a compensatory mitigation proposal, the permittee must consider appropriate and practicable options consistent with the framework at 33 CFR 332.3(b). For activities resulting in the loss of marine or estuarine resources, permittee-responsible mitigation may be environmentally preferable if there are no mitigation banks or in-lieu fee programs in the area that have marine or estuarine credits available for sale or transfer to the permittee. For permittee-responsible mitigation, the special conditions of the NWP verification must clearly indicate the party or parties responsible for the implementation and performance of the compensatory mitigation project, and, if required, its long-term management.

(i) Where certain functions and services of waters of the United States are permanently adversely affected by a regulated activity, such as discharges of dredged or fill material into waters of the United States that will convert a forested or scrub-shrub wetland to an herbaceous wetland in a permanently maintained utility line right-of-way, mitigation may be required to reduce the adverse environmental effects of the activity to the no more than minimal level.

24. **Safety of Impoundment Structures.** To ensure that all impoundment structures are safely designed, the district engineer may require non-Federal applicants to demonstrate that the structures comply with established state or federal, dam safety criteria or have been designed by qualified persons. The district engineer may also require documentation that the design has been independently reviewed by similarly qualified persons, and appropriate modifications made to ensure safety.

25. **Water Quality.**

(a) Where the certifying authority (state, authorized tribe, or EPA, as appropriate) has not previously certified compliance of an NWP with CWA section 401, a CWA section 401 water quality certification for the proposed discharge must be obtained or waived (see 33 CFF 330.4(c)). If the permittee cannot comply with all of the conditions of a water quality certification previously issued by certifying authority for the issuance of the NWP, then the permittee must obtain a water quality certification or waiver for the proposed discharge in order for the activity to be authorized by an NWP.

(b) If the NWP activity requires pre-construction notification and the certifying authority has not previously certified compliance of an NWP with CWA section 401, the proposed discharge is not authorized by an NWP until water quality certification is obtained or waived. If the certifying authority issues a water quality certification for the proposed discharge, the permittee must submit a copy of the certification to the district engineer. The discharge is not authorized by an NWP until the district engineer has notified the permittee that the water quality certification requirement has been satisfied by the issuance of a water quality certification or a waiver.

(c) The district engineer or certifying authority may require additional water quality management measures to ensure that the authorized activity does not result in more than minimal degradation of water quality.

26. **Coastal Zone Management.** In coastal states where an NWP has not previously received a state coastal zone management consistency concurrence, an individual state coastal zone management consistency concurrence must be obtained, or a presumption of concurrence must occur (see 33 CFR 330.4(d)). If the permittee cannot comply with all of the conditions of a coastal zone management consistency concurrence previously issued by the state, then the permittee must obtain an individual coastal zone management consistency concurrence or presumption of concurrence in order for the activity to be authorized by an NWP. The district engineer or a state may require additional measures to ensure that the authorized activity is consistent with state coastal zone management requirements.

27. **Regional and Case-By-Case Conditions.** The activity must comply with any regional conditions that may have been added by the Division Engineer (see 33 CFR 330.4(e)) and with any case specific conditions added by the Corps or by the state, Indian Tribe, or U.S. EPA in its CWA section 401 Water Quality Certification, or by the state in its Coastal Zone Management Act consistency determination.

28. **Use of Multiple Nationwide Permits.** The use of more than one NWP for a single and complete project is authorized, subject to the following restrictions:

(a) If only one of the NWPs used to authorize the single and complete project has a specified acreage limit, the acreage loss of waters of the United States cannot exceed the acreage limit of the NWP with the highest specified acreage limit. For example, if a road crossing over tidal waters is constructed under NWP 14, with associated bank stabilization authorized by NWP 13, the maximum acreage loss of waters of the United States for the total project cannot exceed 1/3-acre.

(b) If one or more of the NWPs used to authorize the single and complete project has specified acreage limits, the acreage loss of waters of the United States authorized by those NWPs cannot exceed their respective specified acreage limits. For example, if a commercial development is constructed under NWP 39, and the single and complete project includes the filling of an upland ditch authorized by NWP 46, the maximum acreage loss of waters of the United States for the commercial development under NWP 39 cannot exceed 1/2-acre, and the total acreage loss of waters of United States due to the NWP 39 and 46 activities cannot exceed 1 acre.

29. **Transfer of Nationwide Permit Verifications.** If the permittee sells the property associated with a nationwide permit verification, the permittee may transfer the nationwide permit verification to the new owner by submitting a letter to the appropriate Corps district office to validate the transfer. A copy of the nationwide permit verification must be attached to the letter, and the letter must contain the following statement and signature:

*“When the structures or work authorized by this nationwide permit are still in existence at the time the property is transferred, the terms and conditions of this nationwide permit, including any special conditions, will continue to be binding on the new owner(s) of the property. To validate the transfer of this nationwide permit and the associated liabilities associated with compliance with its terms and conditions, have the transferee sign and date below.”*

(Transferee)

---

(Date)

30. **Compliance Certification.** Each permittee who receives an NWP verification letter from the Corps must provide a signed certification documenting completion of the authorized activity and implementation of any required compensatory mitigation. The success of any required permittee-responsible mitigation, including the achievement of ecological performance standards, will be addressed separately by the district engineer. The Corps will provide the permittee the certification document with the NWP verification letter. The certification document will include:

(a) A statement that the authorized activity was done in accordance with the NWP authorization, including any general, regional, or activity-specific conditions;

(b) A statement that the implementation of any required compensatory mitigation was completed in accordance with the permit conditions. If credits from a mitigation bank or in-lieu fee program are used to satisfy the compensatory mitigation requirements, the certification must include the documentation required by 33 CFR 332.3(l)(3) to confirm that the permittee secured the appropriate number and resource type of credits; and

(c) The signature of the permittee certifying the completion of the activity and mitigation. The completed certification document must be submitted to the district engineer within 30 days of completion of the authorized activity or the implementation of any required compensatory mitigation, whichever occurs later.

31. **Activities Affecting Structures or Works Built by the United States.** If an NWP activity also requires permission from the Corps pursuant to 33 U.S.C. 408 because it will alter or temporarily or permanently occupy or use a U.S. Army Corps of Engineers (USACE) federally authorized Civil Works project (a "USACE project"), the prospective permittee must submit a pre-construction notification. See paragraph (b)(10) of general condition 32. An activity that requires section 408 permission and/or review is not authorized by an NWP until the appropriate Corps office issues the section 408 permission or completes its review to alter, occupy, or use the USACE project, and the district engineer issues a written NWP verification.

32. **Pre-Construction Notification.**

(a) *Timing.* Where required by the terms of the NWP, the permittee must notify the district engineer by submitting a pre-construction notification (PCN) as early as possible. The district engineer must determine if the PCN is complete within 30 calendar days of the date of receipt and, if the PCN is determined to be incomplete, notify the prospective permittee within that 30 day period to request the additional information necessary to make the PCN complete. The request must specify the information needed to make the PCN complete. As a general rule, district engineers will request additional information necessary to make the PCN complete only once. However, if the prospective permittee does not provide all of the requested information, then the district engineer will notify the prospective permittee that the PCN is still incomplete and the PCN review process will not commence until all of the requested information has been received by the district engineer. The prospective permittee shall not begin the activity until either:

(1) He or she is notified in writing by the district engineer that the activity may proceed under the NWP with any special conditions imposed by the district or division engineer; or

(2) 45 calendar days have passed from the district engineer's receipt of the complete PCN and the prospective permittee has not received written notice from the district or division engineer. However, if the permittee was required to notify the Corps pursuant to general condition 18 that listed species or critical habitat might be affected or are in the vicinity of the activity, or to notify the Corps pursuant to general condition 20 that the activity might have the potential to cause effects to historic properties, the permittee cannot begin the activity until receiving written notification from the Corps that there is "no effect" on listed species or "no potential to cause effects" on historic properties, or that any consultation required under Section 7 of the Endangered Species Act (see 33 CFR 330.4(f)) and/or section 106 of the National Historic Preservation Act (see 33 CFR 330.4(g)) has been completed. If the proposed activity requires a written waiver to exceed specified limits of an NWP, the permittee may not begin the activity until the district engineer issues the waiver. If the district or division engineer notifies the permittee in writing that an individual permit is required within 45 calendar days of receipt of a complete PCN, the permittee cannot begin the activity until an individual permit has been obtained. Subsequently, the permittee's right to proceed under the NWP may be modified, suspended, or revoked only in accordance with the pr set forth in 33 CFR 330.5(d)(2).

(b) *Contents of Pre-Construction Notification:* The PCN must be in writing and include the following information:

(1) Name, address and telephone numbers of the prospective permittee;

(2) Location of the proposed activity;

(3) Identify the specific NWP or NWP(s) the prospective permittee wants to use to authorize the proposed activity;

(4)

(i) A description of the proposed activity; the activity's purpose; direct and indirect adverse environmental effects the activity would cause, including the anticipated amount of loss of wetlands, other special aquatic sites, and other waters expected to result from the NWP activity, in acres, linear feet, or other appropriate unit of measure; a description of any proposed mitigation measures intended to reduce the adverse environmental effects caused by the proposed activity; and any other NWP(s), regional general permit(s), or individual permit(s) used or intended to be used to authorize any part of the proposed project or any related activity, including other separate and distant crossings for linear projects that require Department of the Army authorization but do not require pre-construction notification. The description of the proposed activity and any proposed mitigation measures should be sufficiently detailed to allow the district engineer to determine that the adverse environmental effects of the activity will be no more than minimal and to determine the need for compensatory mitigation or other mitigation measures.

(ii) For linear projects where one or more single and complete crossings require pre-construction notification, the PCN must include the quantity of anticipated losses of wetlands, other special aquatic sites, and other waters for each single and complete crossing of those wetlands, other special aquatic sites, and other waters (including those single and complete crossings authorized by an NWP but do not require PCNs). This information will be used by the district engineer to evaluate the cumulative adverse

environmental effects of the proposed linear project and does not change those non-PCN NWP activities into NWP PCNs.

(iii) Sketches should be provided when necessary to show that the activity complies with the terms of the NWP. (Sketches usually clarify the activity and when provided results in a quicker decision. Sketches should contain sufficient detail to provide an illustrative description of the proposed activity (e.g., a conceptual plan), but do not need to be detailed engineering plans).

(5) The PCN must include a delineation of wetlands, other special aquatic sites, and other waters, such as lakes and ponds, and perennial and intermittent streams, on the project site. Wetland delineations must be prepared in accordance with the current method required by the Corps. The permittee may ask the Corps to delineate the special aquatic sites and other waters on the project site, but there may be a delay if the Corps does the delineation, especially if the project site is large or contains many wetlands, other special aquatic sites, and other waters. Furthermore, the 45-day period will not start until the delineation has been submitted to or completed by the Corps, as appropriate.

(6) If the proposed activity will result in the loss of greater than 1/10-acre of wetlands or 3/100-acre of stream bed and a PCN is required, the prospective permittee must submit a statement describing how the mitigation requirement will be satisfied, or explaining why the adverse environmental effects are no more than minimal and why compensatory mitigation should not be required. As an alternative, the prospective permittee may submit a conceptual or detailed mitigation plan.

(7) For non-federal permittees, if any listed species (or species proposed for listing) or designated critical habitat (or critical habitat proposed for such designation) might be affected or is in the vicinity of the activity, or if the activity is located in designated critical habitat (or critical habitat proposed for such designation), the PCN must include the name(s) of those endangered or threatened species (or species proposed for listing) that might be affected by the proposed activity or utilize the designated critical habitat (or critical habitat proposed for such designation) that might be affected by the proposed activity. For NWP activities that require pre-construction notification, Federal permittees must provide documentation demonstrating compliance with the Endangered Species Act.

(8) For non-federal permittees, if the NWP activity might have the potential to cause effects to a historic property listed on, determined to be eligible for listing on, or potentially eligible for listing on, the National Register of Historic Places, the PCN must state which historic property might have the potential to be affected by the proposed activity or include a vicinity map indicating the location of the historic property. For NWP activities that require pre-construction notification, Federal permittees must provide documentation demonstrating compliance with section 106 of the National Historic Preservation Act.

(9) For an activity that will occur in a component of the National Wild and Scenic River System, or in a river officially designated by Congress as a “study river” for possible inclusion in the system while the river is in an official study status, the PCN must identify the Wild and Scenic River or the “study river” (see general condition 16); and

(10) For an NWP activity that requires permission from, or review by, the Corps pursuant to 33 U.S.C. 408 because it will alter or temporarily or permanently occupy or use a U.S. Army Corps of Engineers federally authorized civil works project, the pre-construction notification must include a statement confirming that the project proponent has submitted a

written request for section 408 permission from, or review by, the Corps office having jurisdiction over that USACE project.

(c) *Form of Pre-Construction Notification:* The nationwide permit pre-construction notification form (Form ENG 6082) should be used for NWP PCNs. A letter containing the required information may also be used. Applicants may provide electronic files of PCNs and supporting materials if the district engineer has established tools and procedures for electronic submittals.

(d) *Agency Coordination:*

(1) The district engineer will consider any comments from Federal and state agencies concerning the proposed activity's compliance with the terms and conditions of the NWPs and the need for mitigation to reduce the activity's adverse environmental effects so that they are no more than minimal.

(2) Agency coordination is required for:

(i) All NWP activities that require pre-construction notification and result in the loss of greater than 1/2-acre of waters of the United States;

(ii) NWP 13 activities in excess of 500 linear feet, fills greater than one cubic yard per running foot, or involve discharges of dredged or fill material into special aquatic sites; and

(iii) NWP 54 activities in excess of 500 linear feet, or that extend into the waterbody more than 30 feet from the mean low water line in tidal waters or the ordinary high water mark in the Great Lakes.

(3) When agency coordination is required, the district engineer will immediately provide (e.g., via email, facsimile transmission, overnight mail, or other expeditious manner) a copy of the complete PCN to the appropriate Federal or state offices (FWS, state natural resource or water quality agency, EPA, and, if appropriate, the NMFS). With the exception of NWP 37, these agencies will have 10 calendar days from the date the material is transmitted to notify the district engineer via telephone, facsimile transmission, or email that they intend to provide substantive, site-specific comments. The comments must explain why the agency believes the adverse environmental effects will be more than minimal. If so, contacted by an agency, the district engineer will wait an additional 15 calendar days before making a decision on the pre-construction notification. The district engineer will fully consider agency comments received within the specified time frame concerning the proposed activity's compliance with the terms and conditions of the NWPs, including the need for mitigation to ensure that the net adverse environmental effects of the proposed activity are no more than minimal. The district engineer will provide no response to the resource agency, except as provided below. The district engineer will indicate in the administrative record associated with each pre-construction notification that the resource agencies' concerns were considered. For NWP 37, the emergency watershed protection and rehabilitation activity may proceed immediately in cases where there is an unacceptable hazard to life or a significant loss of property or economic hardship will occur. The district engineer will consider any comments received to decide whether the NWP 37 authorization should be modified, suspended, or revoked in accordance with the procedures at 33 CFR 330.5.

(4) In cases of where the prospective permittee is not a Federal agency, the district engineer will provide a response to NMFS within 30 calendar days of receipt of any Essential Fish Habitat conservation recommendations, as required by section 305(b)(4)(B) of the Magnuson-Stevens Fishery Conservation and Management Act.

(5) Applicants are encouraged to provide the Corps with either electronic files or multiple copies of pre-construction notifications to expedite agency coordination.

## **DISTRICT ENGINEER'S DECISION**

1. In reviewing the PCN for the proposed activity, the district engineer will determine whether the activity authorized by the NWP will result in more than minimal individual or cumulative adverse environmental effects or may be contrary to the public interest. If a project proponent requests authorization by a specific NWP, the district engineer should issue the NWP verification for that activity if it meets the terms and conditions of that NWP, unless he or she determines, after considering mitigation, that the proposed activity will result in more than minimal individual and cumulative adverse effects on the aquatic environment and other aspects of the public interest and exercises discretionary authority to require an individual permit for the proposed activity. For a linear project, this determination will include an evaluation of the single and complete crossings of waters of the United States that require PCNs to determine whether they individually satisfy the terms and conditions of the NWP(s), as well as the cumulative effects caused by all of the crossings of waters of the United States authorized by an NWP. If an applicant requests a waiver of an applicable limit, as provided for in NWPs 13, 36, or 54, the district engineer will only grant the waiver upon a written determination that the NWP activity will result in only minimal individual and cumulative adverse environmental effects.

2. When making minimal adverse environmental effects determinations the district engineer will consider the direct and indirect effects caused by the NWP activity. He or she will also consider the cumulative adverse environmental effects caused by activities authorized by an NWP and whether those cumulative adverse environmental effects are no more than minimal. The district engineer will also consider site specific factors, such as the environmental setting in the vicinity of the NWP activity, the type of resource that will be affected by the NWP activity, the functions provided by the aquatic resources that will be affected by the NWP activity, the degree or magnitude to which the aquatic resources perform those functions, the extent that aquatic resource functions will be lost as a result of the NWP activity (e.g., partial or complete loss), the duration of the adverse effects (temporary or permanent), the importance of the aquatic resource functions to the region (e.g., watershed or ecoregion), and mitigation required by the district engineer. If an appropriate functional or condition assessment method is available and practicable to use, that assessment method may be used by the district engineer to assist in the minimal adverse environmental effects determination. The district engineer may add case-specific special conditions to the NWP authorization to address site-specific environmental concerns.

3. If the proposed activity requires a PCN and will result in a loss of greater than 1/10-acre of wetlands or 3/100-acre of stream bed, the prospective permittee should submit a mitigation proposal with the PCN. Applicants may also propose compensatory mitigation for NWP activities with smaller impacts, or for impacts to other types of waters. The district engineer will consider any proposed compensatory mitigation or other mitigation measures the applicant has included in the proposal in determining whether the net adverse environmental effects of the proposed activity are no more than minimal. The compensatory mitigation proposal may be either conceptual or detailed. If the district engineer determines that the activity complies with

the terms and conditions of the NWP and that the adverse environmental effects are no more than minimal, after considering mitigation, the district engineer will notify the permittee and include any activity-specific conditions in the NWP verification the district engineer deems necessary. Conditions for compensatory mitigation requirements must comply with the appropriate provisions at 33 CFR 332.3(k). The district engineer must approve the final mitigation plan before the permittee commences work in waters of the United States, unless the district engineer determines that prior approval of the final mitigation plan is not practicable or not necessary to ensure timely completion of the required compensatory mitigation. If the prospective permittee elects to submit a compensatory mitigation plan with the PCN, the district engineer will expeditiously review the proposed compensatory mitigation plan. The district engineer must review the proposed compensatory mitigation plan within 45 calendar days of receiving a complete PCN and determine whether the proposed mitigation would ensure that the NWP activity results in no more than minimal adverse environmental effects. If the net adverse environmental effects of the NWP activity (after consideration of the mitigation proposal) are determined by the district engineer to be no more than minimal, the district engineer will provide a timely written response to the applicant. The response will state that the NWP activity can proceed under the terms and conditions of the NWP, including any activity-specific conditions added to the NWP authorization by the district engineer.

4. If the district engineer determines that the adverse environmental effects of the proposed activity are more than minimal, then the district engineer will notify the applicant either:

(a) That the activity does not qualify for authorization under the NWP and instruct the applicant on the procedures to seek authorization under an individual permit;

(b) that the activity is authorized under the NWP subject to the applicant's submission of a mitigation plan that would reduce the adverse environmental effects so that they are no more than minimal; or

(c) that the activity is authorized under the NWP with specific modifications or conditions. Where the district engineer determines that mitigation is required to ensure no more than minimal adverse environmental effects, the activity will be authorized within the 45-day PCN period (unless additional time is required to comply with general conditions 18, 20, and/or 31), with activity-specific conditions that state the mitigation requirements. The authorization will include the necessary conceptual or detailed mitigation plan or a requirement that the applicant submit a mitigation plan that would reduce the adverse environmental effects so that they are no more than minimal. When compensatory mitigation is required, no work in waters of the United States may occur until the district engineer has approved a specific mitigation plan or has determined that prior approval of a final mitigation plan is not practicable or not necessary to ensure timely completion of the required compensatory mitigation.

## **FURTHER INFORMATION**

1. District engineers have authority to determine if an activity complies with the terms and conditions of an NWP.
2. NWPs do not obviate the need to obtain other federal, state, or local permits, approvals, or authorizations required by law.
3. NWPs do not grant any property rights or exclusive privileges.
4. NWPs do not authorize any injury to the property or rights of others.
5. NWPs do not authorize interference with any existing or proposed Federal project (see general condition 31).



## DEFINITIONS

Best management practices (BMPs): Policies, practices, procedures, or structures implemented to mitigate the adverse environmental effects on surface water quality resulting from development. BMPs are categorized as structural or non-structural.

Compensatory mitigation: The restoration (re-establishment or rehabilitation), establishment (creation), enhancement, and/or in certain circumstances preservation of aquatic resources for the purposes of offsetting unavoidable adverse impacts which remain after all appropriate and practicable avoidance and minimization has been achieved.

Currently serviceable: Useable as is or with some maintenance, but not so degraded as to essentially require reconstruction.

Direct effects: Effects that are caused by the activity and occur at the same time and place.

Discharge: The term “discharge” means any discharge of dredged or fill material into waters of the United States.

Ecological reference: A model used to plan and design an aquatic habitat and riparian area restoration, enhancement, or establishment activity under NWP 27. An ecological reference may be based on the structure, functions, and dynamics of an aquatic habitat type or a riparian area type that currently exists in the region where the proposed NWP 27 activity is located. Alternatively, an ecological reference may be based on a conceptual model for the aquatic habitat type or riparian area type to be restored, enhanced, or established as a result of the proposed NWP 27 activity. An ecological reference takes into account the range of variation of the aquatic habitat type or riparian area type in the region.

Enhancement: The manipulation of the physical, chemical, or biological characteristics of an aquatic resource to heighten, intensify, or improve a specific aquatic resource function(s). Enhancement results in the gain of selected aquatic resource function(s), but may also lead to a decline in other aquatic resource function(s). Enhancement does not result in a gain in aquatic resource area.

Establishment (creation): The manipulation of the physical, chemical, or biological characteristics present to develop an aquatic resource that did not previously exist at an upland site. Establishment results in a gain in aquatic resource area.

High Tide Line: The line of intersection of the land with the water’s surface at the maximum height reached by a rising tide. The high tide line may be determined, in the absence of actual data, by a line of oil or scum along shore objects, a more or less continuous deposit of fine shell or debris on the foreshore or berm, other physical markings or characteristics, vegetation lines, tidal gages, or other suitable means that delineate the general height reached by a rising tide. The line encompasses spring high tides and other high tides that occur with periodic frequency but does not include storm surges in which there is a departure from the normal or predicted reach of the tide due to the piling up of water against a coast by strong winds such as those accompanying a hurricane or other intense storm.

Historic Property: Any prehistoric or historic district, site (including archaeological site), building, structure, or other object included in, or eligible for inclusion in, the National

Register of Historic Places maintained by the Secretary of the Interior. This term includes artifacts, records, and remains that are related to and located within such properties. The term includes properties of traditional religious and cultural importance to an Indian tribe or Native Hawaiian organization and that meet the National Register criteria (36 CFR part 60).

Independent utility: A test to determine what constitutes a single and complete non-linear project in the Corps Regulatory Program. A project is considered to have independent utility if it would be constructed absent the construction of other projects in the project area. Portions of a multi-phase project that depend upon other phases of the project do not have independent utility. Phases of a project that would be constructed even if the other phases were not built can be considered as separate single and complete projects with independent utility.

Indirect effects: Effects that are caused by the activity and are later in time or farther removed in distance but are still reasonably foreseeable.

Loss of waters of the United States: Waters of the United States that are permanently adversely affected by filling, flooding, excavation, or drainage because of the regulated activity. The loss of stream bed includes the acres of stream bed that are permanently adversely affected by filling or excavation because of the regulated activity. Permanent adverse effects include permanent discharges of dredged or fill material that change an aquatic area to dry land, increase the bottom elevation of a waterbody, or change the use of a waterbody. The acreage of loss of waters of the United States is a threshold measurement of the impact to jurisdictional waters or wetlands for determining whether a project may qualify for an NWP; it is not a net threshold that is calculated after considering compensatory mitigation that may be used to offset losses of aquatic functions and services. Waters of the United States temporarily filled, flooded, excavated, or drained, but restored to pre-construction contours and elevations after construction, are not included in the measurement of loss of waters of the United States. Impacts resulting from activities that do not require Department of the Army authorization, such as activities eligible for exemptions under section 404(f) of the Clean Water Act, are not considered when calculating the loss of waters of the United States.

Navigable waters: Waters subject to section 10 of the Rivers and Harbors Act of 1899. These waters are defined at 33 CFR part 329.

Non-tidal wetland: A non-tidal wetland is a wetland that is not subject to the ebb and flow of tidal waters. Non-tidal wetlands contiguous to tidal waters are located landward of the high tide line (i.e., spring high tide line).

Open water: For purposes of the NWPs, an open water is any area that in a year with normal patterns of precipitation has water flowing or standing above ground to the extent that an ordinary high water mark can be determined. Aquatic vegetation within the area of flowing or standing water is either non-emergent, sparse, or absent. Vegetated shallows are considered to be open waters. Examples of "open waters" include rivers, streams, lakes, and ponds.

Ordinary High Water Mark: The term ordinary high water mark means that line on the shore established by the fluctuations of water and indicated by physical characteristics such as a clear, natural line impressed on the bank, shelving, changes in the character of soil, destruction of terrestrial vegetation, the presence of litter and debris, or other appropriate means that consider the characteristics of the surrounding areas.

Perennial stream: A perennial stream has surface water flowing continuously year-round during a typical year.

**Practicable:** Available and capable of being done after taking into consideration cost, existing technology, and logistics in light of overall project purposes.

**Pre-construction notification:** A request submitted by the project proponent to the Corps for confirmation that a particular activity is authorized by nationwide permit. The request may be a permit application, letter, or similar document that includes information about the proposed work and its anticipated environmental effects. Pre-construction notification may be required by the terms and conditions of a nationwide permit, or by regional conditions. A pre-construction notification may be voluntarily submitted in cases where pre-construction notification is not required and the project proponent wants confirmation that the activity is authorized by nationwide permit.

**Preservation:** The removal of a threat to, or preventing the decline of, aquatic resources by an action in or near those aquatic resources. This term includes activities commonly associated with the protection and maintenance of aquatic resources through the implementation of appropriate legal and physical mechanisms. Preservation does not result in a gain of aquatic resource area or functions.

**Re-establishment:** The manipulation of the physical, chemical, or biological characteristics of a site with the goal of returning natural/historic functions to a former aquatic resource. Re-establishment results in rebuilding a former aquatic resource and results in a gain in aquatic resource area and functions.

**Rehabilitation:** The manipulation of the physical, chemical, or biological characteristics of a site with the goal of repairing natural/historic functions to a degraded aquatic resource. Rehabilitation results in a gain in aquatic resource function but does not result in a gain in aquatic resource area.

**Restoration:** The manipulation of the physical, chemical, or biological characteristics of a site with the goal of returning natural/historic functions to a former or degraded aquatic resource. For the purpose of tracking net gains in aquatic resource area, restoration is divided into two categories: Re-establishment and rehabilitation.

**Riffle and pool complex:** Riffle and pool complexes are special aquatic sites under the 404(b)(1) Guidelines. Riffle and pool complexes sometimes characterize steep gradient sections of streams. Such stream sections are recognizable by their hydraulic characteristics. The rapid movement of water over a coarse substrate in riffles results in a rough flow, a turbulent surface, and high dissolved oxygen levels in the water. Pools are deeper areas associated with riffles. A slower stream velocity, a streaming flow, a smooth surface, and a finer substrate characterize pools.

**Riparian areas:** Riparian areas are lands next to streams, lakes, and estuarine-marine shorelines. Riparian areas are transitional between terrestrial and aquatic ecosystems, through which surface and subsurface hydrology connects riverine, lacustrine, estuarine, and marine waters with their adjacent wetlands, non-wetland waters, or uplands. Riparian areas provide a variety of ecological functions and services and help improve or maintain local water quality. (See general condition 23.)

**Shellfish seeding:** The placement of shellfish seed and/or suitable substrate to increase shellfish production. Shellfish seed consists of immature individual shellfish or individual shellfish attached to shells or shell fragments (i.e., spat on shell). Suitable substrate may

consist of shellfish shells, shell fragments, or other appropriate materials placed into waters for shellfish habitat.

Single and complete linear project: A linear project is a project constructed for the purpose of getting people, goods, or services from a point of origin to a terminal point, which often involves multiple crossings of one or more waterbodies at separate and distant locations. The term “single and complete project” is defined as that portion of the total linear project proposed or accomplished by one owner/developer or partnership or other association of owners/developers that includes all crossings of a single water of the United States (i.e., a single waterbody) at a specific location. For linear projects crossing a single or multiple waterbodies several times at separate and distant locations, each crossing is considered a single and complete project for purposes of NWP authorization. However, individual channels in a braided stream or river, or individual arms of a large, irregularly shaped wetland or lake, etc., are not separate waterbodies, and crossings of such features cannot be considered separately.

Single and complete non-linear project: For non-linear projects, the term “single and complete project” is defined at 33 CFR 330.2(i) as the total project proposed or accomplished by one owner/developer or partnership or other association of owners/developers. A single and complete non-linear project must have independent utility (see definition of “independent utility”). Single and complete non-linear projects may not be “piecemealed” to avoid the limits in an NWP authorization.

Stormwater management: Stormwater management is the mechanism for controlling stormwater runoff for the purposes of reducing downstream erosion, water quality degradation, and flooding and mitigating the adverse effects of changes in land use on the aquatic environment.

Stormwater management facilities: Stormwater management facilities are those facilities, including but not limited to, stormwater retention and detention ponds and best management practices, which retain water for a period of time to control runoff and/or improve the quality (i.e., by reducing the concentration of nutrients, sediments, hazardous substances and other pollutants) of stormwater runoff.

Stream bed: The substrate of the stream channel between the ordinary high water marks. The substrate may be bedrock or inorganic particles that range in size from clay to boulders. Wetlands contiguous to the stream bed, but outside of the ordinary high water marks, are not considered part of the stream bed.

Stream channelization: The manipulation of a stream’s course, condition, capacity, or location that causes more than minimal interruption of normal stream processes. A channelized jurisdictional stream remains a water of the United States.

Structure: An object that is arranged in a definite pattern of organization. Examples of structures include, without limitation, any pier, boat dock, boat ramp, wharf, dolphin, weir, boom, breakwater, bulkhead, revetment, riprap, jetty, artificial island, artificial reef, permanent mooring structure, power transmission line, permanently moored floating vessel, piling, aid to navigation, or any other manmade obstacle or obstruction.

Tidal wetland: A tidal wetland is a jurisdictional wetland that is inundated by tidal waters. Tidal waters rise and fall in a predictable and measurable rhythm or cycle due to the gravitational pulls of the moon and sun. Tidal waters end where the rise and fall of the water surface can no

longer be practically measured in a predictable rhythm due to masking by other waters, wind, or other effects. Tidal wetlands are located channelward of the high tide line.

Tribal lands: Any lands title to which is either: (1) Held in trust by the United States for the benefit of any Indian tribe or individual; or (2) held by any Indian tribe or individual subject to restrictions by the United States against alienation.

Tribal rights: Those rights legally accruing to a tribe or tribes by virtue of inherent sovereign authority, unextinguished aboriginal title, treaty, statute, judicial decisions, executive order or agreement, and that give rise to legally enforceable remedies.

Vegetated shallows: Vegetated shallows are special aquatic sites under the 404(b)(1) Guidelines. They are areas that are permanently inundated and under normal circumstances have rooted aquatic vegetation, such as seagrasses in marine and estuarine systems and a variety of vascular rooted plants in freshwater systems.

Waterbody: For purposes of the NWP, a waterbody is a “water of the United States.” If a wetland is adjacent to a waterbody determined to be a water of the United States, that waterbody and any adjacent wetlands are considered together as a single aquatic unit (see 33 CFR 328.4(c)(2)).

## REGIONAL CONDITIONS:

The following Regional Conditions have been approved by the Wilmington District for the Nationwide Permits (NWP) published in the January 13, 2021, and December 27, 2021, *Federal Register* (86 FR 2744 and 86 FR 73522) announcing the reissuance of 52 existing (NWP) and five new NWP, as well as the reissuance of NWP general conditions and definitions with some modifications.

### A. EXCLUDED WATER AND/OR AREAS

The Corps has identified waters that will be excluded from the use of all NWP's during certain timeframes. These waters are:

1. **Anadromous Fish Spawning Areas.** Work in waters of the U.S. designated by either the North Carolina Division of Marine Fisheries (NCDMF) or the North Carolina Wildlife Resources Commission (NCWRC) as anadromous fish spawning areas are prohibited from February 15th through June 30th, without prior written approval from the Corps and the appropriate wildlife agencies (NCDMF, NCWRC and/or the National Marine Fisheries Service (NMFS)). Work in waters of the U.S. designated by NCWRC as primary nursery areas in inland waters are prohibited from February 15th through September 30th, without prior written approval from the Corps and the appropriate wildlife agencies. Work in waters of the U.S. designated by NCDMF as primary nursery areas shall be coordinated with NCDMF prior to being authorized by this NWP. Coordination with NCDMF may result in a required construction moratorium during periods of significant biological productivity or critical life stages.
2. **Trout Waters Moratorium.** Work in waters of the U.S. in the designated trout watersheds of North Carolina are prohibited from October 15th through April 15th without prior written approval from the NCWRC, or from the Eastern Band of Cherokee Indians (EBCI) Fisheries and Wildlife Management (FWM) office if the project is located on EBCI trust land. (See Section C.3. below for information on the designated trout watersheds).
3. **Sturgeon Spawning Areas.** No in-water work shall be conducted in waters of the U.S. designated by the National Marine Fisheries Service as Atlantic sturgeon critical habitat from February 1st through June 30th. No in-water work shall be conducted in waters of the U.S. in the Roanoke River designated as Atlantic sturgeon critical habitat from February 1st through June 30th, and August 1st through October 31st, without prior written approval from NMFS.
4. **Submerged Aquatic Vegetation.** Impacts to Submerged Aquatic Vegetation (SAV) are not authorized by any NWP, except NWP 48, NWP 55 and NWP 56, unless Essential Fish Habitat (EFH) consultation has been completed pursuant to the Magnuson-Stevens Fisheries Conservation and Management Act (Magnuson-Stevens Act). Permittees shall submit a PCN (See NWP General Condition 32) to the District Engineer prior to commencing the activity if the project would affect SAV. The permittee may not begin work until notified by the Corps that the requirements of the Magnuson-Stevens Act have been satisfied and that the activity is verified.

### B. REGIONAL CONDITIONS APPLICABLE TO ALL NWP's

1. **Critical Habitat in Western NC.** For proposed activities within waters of the U.S. that require a Pre-Construction Notification (PCN) and are located in the thirteen counties listed below, permittees must provide a copy of the PCN to the U.S. Fish and Wildlife Service (USFWS), 160 Zillicoa Street, Asheville, North Carolina 28801 and the Corps Asheville Regulatory Field Office. Please see General Condition 18 for specific PCN requirements

related to the Endangered Species Act and the below website for information on the location of designated critical habitat.

Counties with tributaries that drain to designated critical habitat that require notification to the Asheville U.S. Fish and Wildlife Service: Avery, Cherokee, Graham, Haywood, Henderson, Jackson, Macon, Mecklenburg, Mitchell, Swain, Transylvania, Union and Yancey.

Website and office addresses for Endangered Species Act Information:

The Wilmington District has developed the following website for permittees which provides guidelines on how to review linked websites and maps in order to fulfill NWP General Condition 18 (Endangered Species) requirements:

<http://www.saw.usace.army.mil/Missions/RegulatoryPermitProgram/AgencyCoordination/ESA.aspx>.

Permittees who do not have internet access may contact the appropriate U.S. Fish and Wildlife Service offices listed below or Corps at (910) 251-4850.

Below is a map of the USFWS Field Office Boundaries:

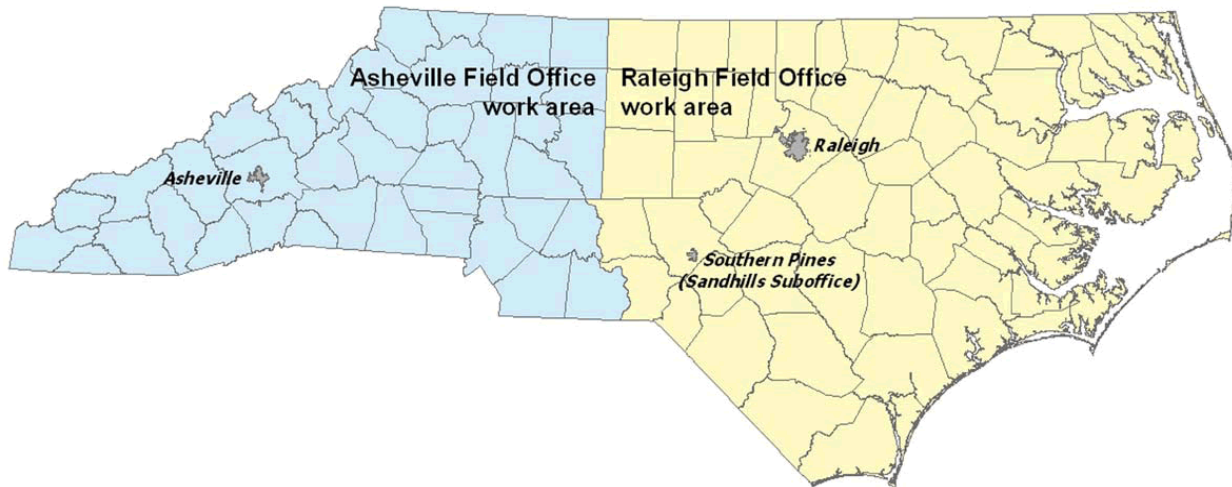

Asheville U.S. Fish and Wildlife Service Office counties: All counties west of and including Anson, Stanly, Davidson, Forsythe and Stokes Counties.

U.S. Fish and Wildlife Service  
Asheville Field Office  
160 Zillicoa Street  
Asheville, NC 28801  
Telephone: (828) 258-3939

Raleigh U.S. Fish and Wildlife Service Office counties: All counties east of and including Richmond, Montgomery, Randolph, Guilford, and Rockingham Counties.

U.S. Fish and Wildlife Service  
Raleigh Field Office  
Post Office Box 33726  
Raleigh, NC 27636-3726  
Telephone: (919) 856-4520

2. **Special Designation Waters.** Prior to the use of any NWP that involves a discharge of dredged or fill material in any of the following identified waters and/or adjacent wetlands in North Carolina, permittees shall submit a PCN to the District Engineer prior to commencing the activity (see General Condition 32). The North Carolina waters and wetlands that require additional PCN requirements are:

“Primary Nursery Areas” (PNA), including inland PNA, as designated by the North Carolina Marine Fisheries Commission and/or the North Carolina Wildlife Resources Commission. The definition of and designated PNA waters can be found in the North Carolina State Administrative Code at Title 15A, Subchapters 3R and 10C (15A NCAC 03R .0103; 15A NCAC 10C .0502; and 15A NCAC 10C .0503) and at the following web pages:

- <http://reports.oah.state.nc.us/ncac/title%2015a%20-%20environmental%20quality/chapter%2003%20-%20marine%20fisheries/subchapter%20r/15a%20ncac%2003r%20.0103.pdf>
- <http://reports.oah.state.nc.us/ncac/title%2015a%20-%20environmental%20quality/chapter%2010%20-%20wildlife%20resources%20and%20water%20safety/subchapter%20c/15a%20ncac%2010c%20.0502.pdf>
- <http://reports.oah.state.nc.us/ncac/title%2015a%20-%20environmental%20quality/chapter%2010%20-%20wildlife%20resources%20and%20water%20safety/subchapter%20c/15a%20ncac%2010c%20.0503.pdf>

3. **Trout Waters.** Prior to any discharge of dredge or fill material into streams, waterbodies or wetlands within the 294 designated trout watersheds of North Carolina, the permittee shall submit a PCN (see General Condition 32) to the District Engineer prior to commencing the activity. The permittee shall also provide a copy of the PCN to the appropriate NCWRC office, or to the EBCI FWM Office (if the project is located on EBCI trust land), to facilitate the determination of any potential impacts to designated Trout Waters.

NCWRC and NC Trout Watersheds:

<b>NCWRC Contact**</b>	<b>Counties that are entirely within Trout Watersheds*</b>	<b>Counties that are partially within Trout Watersheds*</b>
----------------------------	--	---



<p>Mountain Coordinator 645 Fish Hatchery Rd., Building B Marion, NC 28752 828-803- 6054</p> <p>For NCDOT Projects:</p> <p>NCDOT Coordinator 12275 Swift Rd. Oakboro, NC 28129 704-984- 1070</p>	<p>Alleghany Ashe Avery Graham Haywood</p>	<p>Jackson Macon Swain Transylvania Watauga</p>	<p>Burke Buncombe Caldwell Cherokee Clay Henderson Madison</p>	<p>McDowell Mitchell Polk Rutherford Surry Wilkes Yancey</p>
<p><b>EBCI Contact**</b></p>	<p><b>Counties that are within Trout Watersheds*</b></p>			
<p>Office of Natural Resources P.O. Box 1747, Cherokee, NC 28719 (828) 359-6113</p>	<p>Qualla Boundary and non- contiguous tracts of trust land located in portions of Swain, Jackson, Haywood, Graham and Cherokee Counties.</p>			

\*NOTE: To determine PCN requirements, contact the Corps Asheville Regulatory Field Office at (828) 271-7980 or view maps showing trout watersheds in each County at the following webpage: <http://www.saw.usace.army.mil/Missions/Regulatory-Permit-Program/Agency-Coordination/Trout/>.

\*\*If a project is located on EBCI trust land, submit the PCN in accordance with Regional Condition C.16. Contact the Corps Asheville Regulatory Field Office at (828) 271-7980 with questions.

4. **Western NC Waters and Corridors.** The permittee shall submit a PCN (see General Condition 32) to the District Engineer prior to commencing the activity in waters of the U.S. if the activity will occur within any of the following identified waters in western North Carolina, within 0.5 mile on either side of these waters, or within 0.75 mile of the Little Tennessee River, as measured from the top of the bank of the respective water (i.e., river, stream, or creek):

Brasstown Creek  
Burningtown Creek

Cane River  
Caney Fork  
Cartoogechaye Creek  
Chattooga River  
Cheoah River  
Cowee Creek  
Cullasaja River  
Deep Creek  
Ellijay Creek  
French Broad River  
Garden Creek  
Hiwassee River  
Hominy Creek  
Iotla Creek  
Little Tennessee River (within the river or within 0.75 mile on either side of this river)  
Nantahala River  
Nolichucky River  
North Fork French Broad River  
North Toe River  
Nottley River  
Oconaluftee River (portion not located on trust/EBCI land)  
Peachtree Creek  
Shooting Creek  
Snowbird Creek  
South Toe River  
Stecoah Creek  
Swannanoa River  
Sweetwater Creek  
Tuckasegee River (also spelled Tuckaseegee or Tuckaseigee)  
Valley River  
Watauga Creek  
Watauga River  
Wayah Creek  
West Fork French Broad River

To determine PCN requirements, contact the Corps Asheville Regulatory Field Office at (828) 271-7980 or view maps for all corridors at the following webpage:

<http://www.saw.usace.army.mil/Missions/Regulatory-Permit-Program/Agency-Coordination/Designated-Special-Waters.aspx>.

5. **Limitation of Loss of Stream Bed.** NWP's may not be used for activities that may result in the loss of more than 0.05 acres of stream bed, except for NWP 32.

6. **Pre-Construction Notification for Loss of Stream Bed Exceeding 0.02 acres.** The permittee shall submit a PCN to the District Engineer prior to commencing the activity (see General Condition 32) prior to the use of any NWP for any activity that results in the loss of more than 0.02 acres of stream bed. This applies to NWP's that do not have PCN requirements as well as those NWP's that require a PCN.

7. **Mitigation for Loss of Stream Bed.** For any NWP that results in a loss of more than 0.02 acres of stream bed, the permittee shall provide a mitigation proposal to compensate for more than minimal individual and cumulative adverse impacts to the aquatic environment, unless the

District Engineer determines in writing that either some other form of mitigation would be more environmentally appropriate or the adverse effects of the proposed activity are minimal. For stream bed losses of 0.02 acres or less that require a PCN, the District Engineer may determine, on a case-by-case basis, that compensatory mitigation is required to ensure that the activity results in minimal adverse effect on the aquatic environment.

8. **Riprap.** For all NWP's that allow for the use of riprap material for bank stabilization, the following conditions shall be applied:

a. Filter cloth must be placed underneath the riprap as an additional requirement of its use in North Carolina waters. The placement of filter fabric is not required if the riprap will be pushed or "keyed" into the bank of the waterbody. A waiver from the specifications in this Regional Condition must be requested in writing.

b. Riprap shall be placed only on the stream banks, or, if it is necessary to be placed in the stream bed, the finished top elevation of the riprap should not exceed that of the original stream bed.

9. **Culvert Placement.** For all NWP's that allow for culvert placement, the following conditions shall be applied:

a. For all NWP's that involve the construction/installation of culverts, measures shall be included in the construction/installation that will promote the safe passage of fish and other aquatic organisms

Placement of culverts and other structures in streams shall be below the elevation of the streambed by one foot for all culverts with a diameter greater than 48 inches, and 20% of the culvert diameter for culverts having a diameter less than or equal to 48 inches. If the culvert outlet is submerged within a pool or scour hole and designed to provide for aquatic passage, then culvert burial into the streambed is not required.

Culvert burial is not required for structures less than 72 inch diameter/width, where the slope of the culvert will be greater than 2.5%, provided that all alternative options for flattening the slope have been investigated and aquatic life movement/connectivity has been provided when possible (e.g., rock ladders, cross vanes, sills, baffles etc.). Culvert burial is not required when bedrock is present in culvert locations.

Installation of culverts in wetlands shall ensure continuity of water movement and be designed to adequately accommodate high water or flood conditions. When roadways, causeways, or other fill projects are constructed across FEMA-designated floodways or wetlands, openings such as culverts or bridges shall be provided to maintain the natural hydrology of the system as well as prevent constriction of the floodway that may result in destabilization of streams or wetlands.

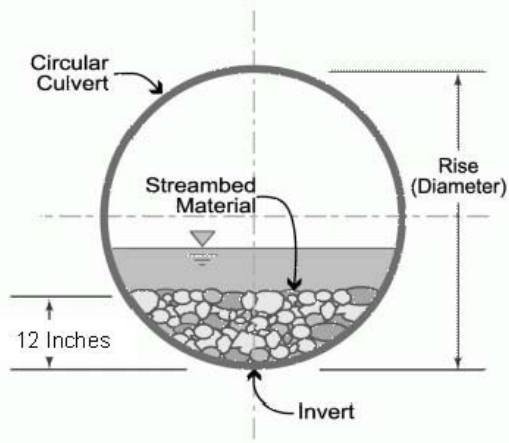

A waiver from the depth specifications in this condition may be requested, in writing, by the permittee and issued by the Corp. This waiver request must be specific as to the reason(s) for the request. The waiver will be issued if it can be demonstrated that the proposed design would result in less impacts to the aquatic environment. Culverts placed across wetland fills purely for the purposes of equalizing surface water do not have to be buried, but the culverts must be of adequate size and/or number to ensure unrestricted transmission of water.

b. Bank-full flows (or less) shall be accommodated through maintenance of the existing bank-full channel cross sectional area. Additional culverts or culvert barrels at such crossings shall be allowed only to receive bank-full flows.



c. Culverts shall be designed and installed in such a manner that the original stream profiles are not altered and allow for aquatic life movement during low flows. The dimension, pattern, and profile of the stream above and below a pipe or culvert shall not be modified by widening the stream channel or by reducing the depth of the stream in connection with the construction activity. The width, height, and gradient of a proposed culvert shall be such as to pass the average historical low flow and spring flow without adversely altering flow velocity. If the width of the culvert is wider than the stream channel, the culvert shall include multiple boxes/pipes, baffles, benches and/or sills to maintain the natural width of the stream channel. If multiple culverts/pipes/barrels are used, low flows shall be accommodated in one culvert/pipe and additional culverts/pipes shall be installed such that they receive only flows above bankfull.

10. **Utility Lines.** For all NWP's that allow for the construction and installation of utility lines, the following conditions shall be applied:

a. Utility lines consisting of aerial electric power transmission lines crossing navigable waters of the U.S. (which are defined at 33 CFR part 329) must comply with the applicable minimum clearances specified in 33 CFR 322.5(i).

b. The work area authorized by this permit, including temporary and/or permanent fills, will be minimized to the greatest extent practicable. Justification for work corridors exceeding forty (40) feet in width is required and will be based on pipeline diameter and length, size of equipment required to construct the utility line, and other construction information deemed necessary to support the request. The permittee is required to provide this information to the Corps with the initial PCN package.

c. A plan to restore and re-vegetate wetland areas cleared for construction must be submitted with the required PCN. Cleared wetland areas shall be re-vegetated, as appropriate, with species of canopy, shrub, and herbaceous species. The permittee shall not use fescue grass or any other species identified as invasive or exotic species by the NC Native Plant Society (NCNPS): <https://ncwildflower.org/invasive-exotic-species-list/>.

d. Any permanently maintained corridor along the utility right of way within forested wetlands shall be considered a loss of aquatic function. A compensatory mitigation plan will be required for all such impacts associated with the requested activity if the activity requires a PCN and the cumulative total of permanent conversion of forested wetlands exceeds 0.1 acres, unless the District Engineer determines in writing that either some other form of mitigation would be more environmentally appropriate or the adverse effects of the proposed activity are minimal.

Where permanently maintained corridor within forested wetlands is 0.1 acres or less, the District Engineer may determine, on a case-by-case basis, that compensatory mitigation is required to ensure that the activity results in minimal adverse effects on the aquatic environment.

e. When directional boring or horizontal directional drilling (HDD) under waters of the U.S., including wetlands, permittees shall closely monitor the project for hydraulic fracturing or “fracking.” Any discharge from hydraulic fracturing or “fracking” into waters of the U.S., including wetlands, shall be reported to the appropriate Corps Regulatory Field Office within 48 hours. Restoration and/or compensatory mitigation may be required as a result of any unintended discharges.

11. **Temporary Access Fills.** The permittee shall submit a PCN to the District Engineer prior to commencing the activity if the activity will involve the discharge of dredged or fill material into more than 0.1 acres of wetlands or 0.02 acres of stream channel for the construction of temporary access fills and/or temporary road crossings. The PCN must include a restoration plan that thoroughly describes how all temporary fills will be removed, how pre-project conditions will be restored, and include a timetable for all restoration activities.

12. **Federal Navigation Channel Setbacks.** Authorized structures and fills located in or adjacent to Federally authorized waterways must be constructed in accordance with the latest setback criteria established by the Wilmington District Engineer. You may review the setback policy at <http://www.saw.usace.army.mil/Missions/Navigation/Setbacks.aspx>. This general permit does not authorize the construction of hardened or permanently fixed structures within the Federally Authorized Channel Setback, unless the activity is approved by the Corps. The permittee shall submit a PCN (see General Condition 32) to the District Engineer to obtain a written verification prior to the construction of any structures or fills within the Federally Authorized Channel Setback.

13. **Northern Long-eared Bat – Endangered Species Act Compliance.** The Wilmington District, U.S. Army Corps of Engineers has consulted with the United States Fish and Wildlife

Service (USFWS) in regard to the threatened northern long-eared bat (NLEB) (*Myotis septentrionalis*) and Standard Local Operating Procedures for Endangered Species (SLOPES) have been approved by the Corps and the USFWS. This condition concerns effects to the NLEB only and does not address effects to other federally listed species and/or federally designated critical habitat.

a. Procedures when the Corps is the lead federal\* agency for a project:

The permittee must comply with (1) and (2) below when:

- the project is located in the western 41 counties of North Carolina, to include non-federal aid North Carolina Department of Transportation (NCDOT) projects, OR;
- the project is located in the 59 eastern counties of North Carolina and is a non-NCDOT project.

\*Generally, if a project is located on private property or on non-federal land, and the project is not being funded by a federal entity, the Corps will be the lead federal agency due to the requirement to obtain Department of the Army authorization to impact waters of the U.S. If the project is located on federal land, contact the Corps to determine the lead federal agency.

(1) A permittee using an NWP must check to see if their project is located in the range of the NLEB by using the following website: <http://www.fws.gov/midwest/endangered/mammals/nleb/pdf/WNSZone.pdf>. If the project is within the range of the NLEB, or if the project includes percussive activities (e.g., blasting, pile driving, etc.), the permittee is then required to check the appropriate website in the paragraph below to discover if their project:

- is located in a 12-digit Hydrologic Unit Code area (“red HUC” - shown as red areas on the map), AND/OR;
- involves percussive activities within 0.25 mile of a red HUC.

Red HUC maps - for the western 41 counties in NC (covered by the Asheville Ecological Services Field Office), check the project location against the electronic maps found at: [http://www.fws.gov/asheville/htmls/project\\_review/NLEB\\_in\\_WNC.html](http://www.fws.gov/asheville/htmls/project_review/NLEB_in_WNC.html). For the eastern 59 counties in NC (covered by the Raleigh Ecological Services Field Office), check the project location against the electronic maps found at: [https://www.fws.gov/raleigh/NLEB\\_RFO.html](https://www.fws.gov/raleigh/NLEB_RFO.html).

(2) A permittee must submit a PCN to the District Engineer, and receive written verification from the District Engineer, prior to commencing the activity, if the activity will involve any of the following:

- tree clearing/removal and/or, construction/installation of wind turbines in a red HUC, AND/OR;
- bridge removal or maintenance, unless the bridge has been inspected and there is no evidence of bat use, (applies anywhere in the range of the NLEB), AND/OR;
- percussive activities in a red HUC, or within 0.25 mile of a red HUC.

The permittee may proceed with the activity without submitting a PCN to either the Corps or the USFWS, provided the activity complies with all applicable NWP terms and general and regional conditions, if the permittee's review under A.(1) and A.(2) above shows that the project is:

- located outside of a red HUC (and there are no percussive activities), and the activity will NOT include bridge removal or maintenance, unless the bridge has been inspected and there is no evidence of bat use, OR;
- located outside of a red HUC and there are percussive activities, but the percussive activities will not occur within 0.25-mile of a red HUC boundary, and the activity will NOT include bridge removal or maintenance, unless the bridge has been inspected and there is no evidence of bat use, OR;
- located in a red HUC, but the activity will NOT include tree clearing/removal; construction/installation of wind turbines; bridge removal or maintenance, unless the bridge has been inspected and there is no evidence of bat use, and/or; any percussive activities.

b. Procedures when the USACE is not the lead federal agency:

For projects where another federal agency is the lead federal agency - if that other federal agency has completed project-specific ESA Section 7(a)(2) consultation for the NLEB, and has (1) determined that the project would not cause prohibited incidental take of the NLEB, and (2) completed coordination/consultation that is required by the USFWS (per the directions on the respective USFWS office's website), that project may proceed without PCN to either the USACE or the USFWS, provided all General and Regional Permit Conditions are met.

The NLEB SLOPES can be viewed on the USACE website at:

<http://www.saw.usace.army.mil/Missions/Regulatory-Permit-Program/Agency-Coordination/ESA/>. Permittees who do not have internet access may contact the USACE at (910) 251- 4633.

14. **West Indian Manatee Protection.** In order to protect the endangered West Indian manatee (*Trichechus manatus*) the Permittee shall implement the USFWS' Manatee Guidelines, and strictly adhere to all requirements therein. The guidelines can be found at <https://www.fws.gov/raleigh/pdfs/ManateeGuidelines2017.pdf>.

15. **ESA Programmatic Biological Opinions.** The Wilmington District, USFWS, NCDOT, and the FHWA have conducted programmatic Section 7(a)(2) consultation for a number of federally listed species and designated critical habitat (DCH), and programmatic consultation concerning other federally listed species and/or DCH may occur in the future. The result of completed programmatic consultation is a Programmatic Biological Opinion (PBO) issued by the USFWS. These PBOs contain mandatory terms and conditions to implement the reasonable and prudent measures that are associated with "incidental take" of whichever species or critical habitat is covered by a specific PBO. Authorization under NWPs is conditional upon the permittee's compliance with all the mandatory terms and conditions associated with incidental take of the applicable PBO (or PBOs), which are incorporated by reference in the NWPs. Failure to comply with the terms and conditions associated with incidental take of an applicable PBO, where a take of the federally listed species occurs, would constitute an unauthorized take by the permittee, and would also constitute permittee non-compliance with the authorization under the NWPs. If the terms and conditions of a specific PBO (or PBOs) apply to a project, the Corps will include this/these requirements in any NWP verification that may be issued for a project. For an activity/project that does not require a PCN, the terms and conditions of the applicable PBO(s) also apply to that non-notifying



activity/project. The USFWS is the appropriate authority to determine compliance with the terms and conditions of its PBO and the ESA. All PBOs can be found on our website at: <https://www.saw.usace.army.mil/Missions/Regulatory-Permit-Program/Agency-Coordination/ESA/>.

#### **16. Work on Eastern Band of Cherokee Indian Land.**

Notifying NWPs - All PCNs submitted for activities in waters of the U.S. on Eastern Band of Cherokee Indians (EBCI) trust land (i.e., Qualla Boundary and non-contiguous tracts of trust land located in portions of Swain, Jackson, Haywood, Graham and Cherokee Counties), must comply with the requirements of the latest MOU between the Wilmington District and the EBCI.

Non-notifying NWPs - Prior to the use of any non-notifying NWP for activities in waters of the U.S. on EBCI trust land (i.e., Qualla Boundary and non-contiguous tracts of trust land located in portions of Swain, Jackson, Haywood, Graham and Cherokee Counties), all prospective permittees must comply with the requirements of the latest MOU between the Wilmington District and the EBCI; this includes coordinating the proposed project with the EBCI Natural Resources Program and obtaining a Tribal Approval Letter from the Tribe.

The EBCI MOU can be found at the following URL: <http://saw-reg.usace.army.mil/FO/Final-MOU-EBCI-USACE.pdf>

#### **17. Sedimentation and Erosion Control Structures and Measures.**

All PCNs will identify and describe sedimentation and erosion control structures and measures proposed for placement in waters of the U.S. The structures and measures should be depicted on maps, surveys or drawings showing location and impacts to jurisdictional wetlands and streams.

### **C. REGIONAL CONDITIONS APPLICABLE TO NWP 3**

1. In designated trout watersheds, a PCN is not required for impacts to a maximum of 0.02 acres for temporary dewatering) of streams and waterbodies when conducting maintenance activities. Minor deviations in an existing structure's configuration, temporary structures and temporary fills are authorized as part of the maintenance activity. In designated trout watersheds, the permittee shall submit a PCN (see Regional Condition C.3 above and General Condition 32) to the District Engineer prior to commencing the activity if; 1) impacts (other than temporary dewatering to work in dry conditions) to streams or waterbodies exceed 0.008 acres; 2) temporary impacts to streams or waterbodies associated with dewatering to work in dry conditions exceeds 0.02 acres; 3) the project will involve impacts to wetlands; 4) the project involves the replacement of a bridge or spanning structure with a culvert or non-spanning structure in waters of the United States; or 5) the activity will be constructed during the trout waters moratorium (October 15 through April 15).

### **D. SECTION 401 WATER QUALITY CERTIFICATION (WQC) AND/OR COASTAL ZONE MANAGEMENT ACT (CZMA) CONSISTENCY DETERMINATION SUMMARY AND APPLICABLE CONDITIONS**

The CZMA Consistency Determination and all Water Quality Certifications for the NWP's can be found at: <https://www.saw.usace.army.mil/Missions/Regulatory-Permit-Program/Permits/2017-Nationwide-Permits/>



**STATE OF NORTH CAROLINA  
DEPARTMENT OF ENVIRONMENTAL QUALITY  
DIVISION OF WATER RESOURCES**

**WATER QUALITY GENERAL CERTIFICATION NO. 4239**

**GENERAL CERTIFICATION FOR PROJECTS ELIGIBLE FOR US ARMY CORPS OF ENGINEERS  
NATIONWIDE PERMIT NUMBER 3 (MAINTENANCE)**

Water Quality General Certification Number 4239 is issued in conformity with the requirements of Section 401, Public Laws 92-500 and 95-217 of the United States and subject to the North Carolina Regulations in 15A NCAC 02H .0500 and 15A NCAC 02B .0200 for the discharge of fill material to surface waters and wetland areas as described in 33 CFR 330 Appendix A (B) (3) of the US Army Corps of Engineers regulations.

The State of North Carolina certifies that the specified category of activity will comply with water quality requirements and applicable portions of Sections 301, 302, 303, 306 and 307 of the Public Laws 92-500 and 95-217 if conducted in accordance with the conditions hereinafter set forth.

Effective date: February 25, 2022

Signed this day: December 18, 2020

By

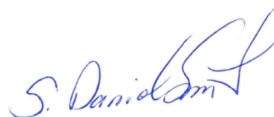

---

S. Daniel Smith  
Director

**GENERAL CERTIFICATION COVERAGE:**

**Activities that are eligible for US Army Corps of Engineers Nationwide Permit 3 qualify for coverage under this General Certification unless they meet one of the thresholds listed below. Activities meeting any one (1) of the thresholds or circumstances listed below are not eligible for coverage under this General Certification and require an Individual 401 Water Quality Certification from the Division of Water Resources (DWR):**

- a) If any of the conditions of this General Certification cannot be met; or
- b) Total additional impacts to streams at an existing impact location greater than 40 linear feet; or
- c) Total additional impacts to wetlands or open waters at an existing impact location equal to or greater than one-tenth (1/10) acre; or
- d) Any impacts to streams from excavation or dredging other than excavation that is conducted as preparation for installing permanent fill or structures; or
- e) Any stream restoration or relocation; or
- f) Complete dewatering and drawdowns to a sediment layer related to pond/dam maintenance or removal unless the dewatering activity has been designed to ensure no discharge of sediment will occur into downstream waters AND has been covered by a Sediment and Erosion Control Plan Approval from the Division of Energy, Mineral, and Land Resources (DEMLR) or a delegated local program; or
- g) Any high-density project, as defined in 15A NCAC 02H .1003(3) and by the density thresholds specified in 15A NCAC 02H .1017, which:
  - i. Disturbs one acre or more of land (including a project that disturbs less than one acre of land that is part of a larger common plan of development or sale); and
  - ii. Has permanent wetland, stream, or open water impacts; and
  - iii. Is proposing new built-upon area; and
  - iv. Does not have a stormwater management plan reviewed and approved under a state stormwater program<sup>1</sup> or a state-approved local government stormwater program<sup>2</sup>.

Projects that have vested rights, exemptions, or other legacy rights or exemptions from state or locally-implemented stormwater programs and projects that satisfy state or locally-implemented stormwater programs through use of community in-lieu fee programs **require an Individual 401 Certification**; or

- h) Any permanent impacts to coastal wetlands [15A NCAC 07H .0205], or Unique Wetlands (UWL) [15A NCAC 02B .0231]; or
- i) Any impacts to subject water bodies and/or state regulated riparian buffers along subject water bodies in the Neuse, Tar-Pamlico, or Catawba River Basins or in the Randleman Lake, Jordan Lake or Goose Creek Watersheds (or any other basin or

---

<sup>1</sup> e.g. Coastal Counties, HQW, ORW, or state-implemented Phase II NPDES

<sup>2</sup> e.g. Delegated Phase II NPDES, Water Supply Watershed, Nutrient-Sensitive Waters, or Universal Stormwater Management Program

## GC4239

watershed with State Regulated Riparian Area Protection Rules [Buffer Rules] in effect at the time of application) *unless*:

- i. The activities are listed as “EXEMPT” or “DEEMED ALLOWABLE” from these rules; or
- ii. A Buffer Authorization Certificate is issued by the NC Division of Coastal Management (DCM); or
- iii. A Buffer Authorization Certificate, Certificate with Exception, or Minor Variance is issued by a delegated or designated local government implementing a state riparian buffer program pursuant to 143-215.23.

In accordance with 15A NCAC 02H .0503(f), the Director of the North Carolina Division of Water Resources may require submission of a formal application for Individual Certification for any project if it is deemed in the public’s best interest or determined that the project is likely to have a significant adverse effect upon water quality, including state or federally listed endangered or threatened aquatic species, or will degrade the waters so that existing uses of the waters or downstream waters are precluded.

This General Certification does not relieve the permittee of the responsibility to obtain all other required Federal, State, or Local approvals before proceeding with the project, including those required by, but not limited to, Sediment and Erosion Control, Non-Discharge, Water Supply Watershed, and Trout Buffer regulations.

This General Certification neither grants nor affirms any property right, license, or privilege in any waters, or any right of use in any waters. This General Certification does not authorize any person to interfere with the riparian rights, littoral rights, or water use rights of any other person and does not create any prescriptive right or any right of priority regarding any usage of water. This General Certification shall not be interposed as a defense in any action respecting the determination of riparian or littoral rights or other rights to water use. No consumptive user is deemed by virtue of this General Certification to possess any prescriptive or other right of priority with respect to any other consumptive user regardless of the quantity of the withdrawal or the date on which the withdrawal was initiated or expanded.

Upon the presentation of proper credentials, DWR may inspect the property.

This General Certification shall expire on the same day as the expiration date of the corresponding Nationwide Permit. The conditions in effect on the date of issuance of Certification for a specific project shall remain in effect for the life of the project, regardless of the expiration date of this General Certification. This General Certification is rescinded when the US Army Corps of Engineers reauthorizes the corresponding Nationwide Permit or when deemed appropriate by the Director of the Division of Water Resources.

Non-compliance with or violation of the conditions herein set forth by a specific project may result in revocation of this General Certification for the project and may also result in criminal and/or civil penalties.

# GC4239

## I. ACTIVITY SPECIFIC CONDITIONS:

1. For all dam removal projects meeting the definition under G.S. 143-215.25 and requirements under G.S. 143-215.27 of a professionally supervised dam removal, the applicant shall provide documentation that any sediment that may be released has similar or lower level of contamination than sediment sampled from downstream of the dam in accordance with Session Law 2017-145.

*Citation: 15A NCAC 02H .0506; 15A NCAC 02H .0507(c); 15A NCAC 02B .0200; 15A NCAC02B .0502*

*Justification: A project that affects waters shall not be permitted unless the existing uses, and the water quality to protect such uses, are protected. In determining that the proposed activity will comply with state water quality standards (including designated uses, numeric criteria, narrative criteria, and the state's antidegradation policy), the Division must evaluate if the activity has avoided and minimized impacts to waters, would cause or contribute to a violation of standards or would result in secondary or cumulative impacts.*

## II. GENERAL CONDITIONS:

1. The permittee shall report to the DWR Regional Office any noncompliance with, and/or any violation of, stream or wetland standards [15A NCAC 02B .0200], including but not limited to sediment impacts to streams or wetlands. Information shall be provided orally within 24 hours (or the next business day if a weekend or holiday) from the time the permittee became aware of the non-compliance circumstances.

*Citation: 15A NCAC 02H .0506(b); 15A NCAC 02H .0507(c)*

*Justification: Timely reporting of non-compliance is important in identifying and minimizing detrimental impacts to water quality and avoiding impacts due to water pollution that precludes any best use on a short-term or long-term basis.*

2. No waste, spoil, solids, or fill of any kind shall occur in wetlands or waters beyond the footprint of the impacts (including temporary impacts); or beyond the thresholds established for use of this General Certification and Nationwide Permit.

*Citation: 15A NCAC 02H .0506; 15A NCAC 02H .0507(c)*

*Justification: Surface water quality standards require that conditions of waters be suitable for all best uses provided for in state rule (including, at minimum: aquatic life propagation, survival, and maintenance of biological integrity; wildlife; secondary contact recreation; agriculture); and that activities must not cause water pollution that precludes any best use on a short-term or long-term basis.*

3. All activities shall be in compliance with any applicable State Regulated Riparian Buffer Rules in Chapter 2B of Title 15A in the North Carolina Administrative Code.

*Citation: 15A NCAC 02H .0506(b); 15A NCAC 02H .0507(c)*

## GC4239

*Justification: The referenced Riparian Buffer rules were adopted to address water quality impairments and further protect existing uses.*

4. When applicable, all construction activities shall be performed and maintained in full compliance with G.S. Chapter 113A Article 4 (Sediment and Pollution Control Act of 1973). Regardless of applicability of the Sediment and Pollution Control Act, all projects shall incorporate appropriate Best Management Practices for the control of sediment and erosion so that no violations of state water quality standards, statutes, or rules occur.

Design, installation, operation, and maintenance of all sediment and erosion control measures shall be equal to or exceed the requirements specified in the most recent version of the *North Carolina Sediment and Erosion Control Manual*, or for linear transportation projects, the *North Carolina Department of Transportation Sediment and Erosion Control Manual*.

All devices shall be maintained on all construction sites, borrow sites, and waste pile (spoil) sites, including contractor-owned or leased borrow pits associated with the project. Sufficient materials required for stabilization and/or repair of erosion control measures and stormwater routing and treatment shall be on site at all times.

For borrow pit sites, the erosion and sediment control measures shall be designed, installed, operated, and maintained in accordance with the most recent version of the *North Carolina Surface Mining Manual*. Reclamation measures and implementation shall comply with the reclamation in accordance with the requirements of the Sedimentation Pollution Control Act and the Mining Act of 1971.

If the project occurs in waters or watersheds classified as Primary Nursery Areas (PNAs), SA, WS-I, WS-II, High Quality Waters (HQW), or Outstanding Resource Waters (ORW), then the sedimentation and erosion control designs shall comply with the requirements set forth in 15A NCAC 04B .0124, *Design Standards in Sensitive Watersheds*.

*Citation: 15A NCAC 02H .0506(b)(2); 15A NCAC 02H .0507(c); 15A NCAC02B .0200; 15A NCAC 02B .0231*

*Justification: A project that affects waters shall not be permitted unless the existing uses, and the water quality to protect such uses, are protected. Activities must not cause water pollution that precludes any best use on a short-term or long-term basis. As cited in Stream Standards: (2) Oils, deleterious substances, or colored or other wastes: only such amounts as shall not render the waters injurious to public health, secondary recreation, or to aquatic life and wildlife, or adversely affect the palatability of fish, aesthetic quality, or impair the waters for any designated uses; and (12) turbidity in the receiving water shall not exceed 50 Nephelometric Turbidity Units (NTU) in streams not designated as trout waters and 10 NTU in streams, lakes, or reservoirs designated as trout waters; for lakes and reservoirs not designated as trout waters, the turbidity shall not exceed 25 NTU; if turbidity exceeds these levels due to natural background conditions, the existing turbidity level shall not be increased. As cited in Wetland Standards: (1) Liquids, fill or other solids, or dissolved gases shall not be present in amounts that may cause adverse impacts on existing wetland uses;*

## GC4239

*and (3) Materials producing color or odor shall not be present in amounts that may cause adverse impacts on existing wetland uses.*

5. Sediment and erosion control measures shall not be installed in wetland or waters except within the footprint of temporary or permanent impacts otherwise authorized by this Certification. If placed within authorized impact areas, then placement of such measures shall not be conducted in a manner that results in dis-equilibrium of any wetlands, streambeds, or streambanks. Any silt fence installed within wetlands shall be removed from wetlands and the natural grade restored within two (2) months of the date that DEMLR or locally delegated program has released the specific area within the project to ensure wetland standards are maintained upon completion of the project.

*Citation: 15A NCAC 02H .0506(b); 15A NCAC 02H .0507(c); 15A NCAC02B .0200; 15A NCAC 02B .0231*

*Justification: A project that affects waters shall not be permitted unless the existing uses, and the water quality to protect such uses, are protected. Activities must not cause water pollution that precludes any best use on a short-term or long-term basis. As cited in Stream Standards: (2) Oils, deleterious substances, or colored or other wastes: only such amounts as shall not render the waters injurious to public health, secondary recreation, or to aquatic life and wildlife, or adversely affect the palatability of fish, aesthetic quality, or impair the waters for any designated uses; and (12) turbidity in the receiving water shall not exceed 50 Nephelometric Turbidity Units (NTU) in streams not designated as trout waters and 10 NTU in streams, lakes, or reservoirs designated as trout waters; for lakes and reservoirs not designated as trout waters, the turbidity shall not exceed 25 NTU; if turbidity exceeds these levels due to natural background conditions, the existing turbidity level shall not be increased. As cited in Wetland Standards: (1) Liquids, fill or other solids, or dissolved gases shall not be present in amounts that may cause adverse impacts on existing wetland uses; and (3) Materials producing color or odor shall not be present in amounts that may cause adverse impacts on existing wetland uses.*

6. Erosion control matting that incorporates plastic mesh and/or plastic twine shall not be used along streambanks or within wetlands.

*Citation: 15A NCAC 02H .0506(b); 15A NCAC 02H .0507(c)*

*Justification: A project that affects waters shall not be permitted unless the existing uses (including aquatic life propagation and biological integrity), and the water quality to protect such uses, are protected. Protections are necessary to ensure any remaining surface waters or wetlands, and any surface waters or wetlands downstream, continue to support existing uses during and after project completion. The Division must evaluate if the activity has avoided and minimized impacts to waters, would cause or contribute to a violation of standards, or would result in secondary or cumulative impacts.*

7. If the project is covered by NPDES Construction Stormwater Permit Number NCG010000 or NPDES Construction Stormwater Permit Number NCG250000, full compliance with permit

## GC4239

conditions including the erosion & sedimentation control plan, inspections and maintenance, self-monitoring, record keeping and reporting requirements is required.

The North Carolina Department of Transportation (NCDOT) shall be required to be in full compliance with the conditions related to construction activities within the most recent version of their Individual NPDES Stormwater Permit Number NCS000250.

*Citation: 15A NCAC 02H .0506(b); 15A NCAC 02H .0507(c); 15A NCAC 02B .0200; 15A NCAC 02B .0231*

*Justification: A project that affects waters shall not be permitted unless the existing uses, and the water quality to protect such uses, are protected. Activities must not cause water pollution that precludes any best use on a short-term or long-term basis. As cited in Stream Standards: (2) Oils, deleterious substances, or colored or other wastes: only such amounts as shall not render the waters injurious to public health, secondary recreation, or to aquatic life and wildlife, or adversely affect the palatability of fish, aesthetic quality, or impair the waters for any designated uses; and (12) turbidity in the receiving water shall not exceed 50 Nephelometric Turbidity Units (NTU) in streams not designated as trout waters and 10 NTU in streams, lakes, or reservoirs designated as trout waters; for lakes and reservoirs not designated as trout waters, the turbidity shall not exceed 25 NTU; if turbidity exceeds these levels due to natural background conditions, the existing turbidity level shall not be increased. As cited in Wetland Standards: (1) Liquids, fill or other solids, or dissolved gases shall not be present in amounts that may cause adverse impacts on existing wetland uses; and (3) Materials producing color or odor shall not be present in amounts that may cause adverse impacts on existing wetland uses.*

8. All work in or adjacent to streams shall be conducted so that the flowing stream does not come in contact with the disturbed area. Approved best management practices from the most current version of the *NC Sediment and Erosion Control Manual*, or the *NC Department of Transportation Construction and Maintenance Activities Manual*, such as sandbags, rock berms, cofferdams, and other diversion structures shall be used to minimize excavation in flowing water.

*Citation: 15A NCAC 02H .0506(b); 15A NCAC 02H .0507(c); 15A NCAC 02B .0200*

*Justification: Surface water quality standards require that conditions of waters be suitable for all best uses provided for in state rule, and that activities must not cause water pollution that precludes any best use on a short-term or long-term basis. As cited in Stream Standards: (2) Oils, deleterious substances, or colored or other wastes: only such amounts as shall not render the waters injurious to public health, secondary recreation, or to aquatic life and wildlife, or adversely affect the palatability of fish, aesthetic quality, or impair the waters for any designated uses; and (12) turbidity in the receiving water shall not exceed 50 Nephelometric Turbidity Units (NTU) in streams not designated as trout waters and 10 NTU in streams, lakes, or reservoirs designated as trout waters; for lakes and reservoirs not designated as trout waters, the turbidity shall not exceed 25 NTU; if turbidity exceeds these levels due to natural background conditions, the existing turbidity level shall not be increased.*

## GC4239

9. If activities must occur during periods of high biological activity (e.g. sea turtle nesting, fish spawning, or bird nesting), then biological monitoring may be required at the request of other state or federal agencies and coordinated with these activities.

All moratoriums on construction activities established by the NC Wildlife Resources Commission (WRC), US Fish and Wildlife Service (USFWS), NC Division of Marine Fisheries (DMF), or National Marine Fisheries Service (NMFS) shall be implemented. Exceptions to this condition require written approval by the resource agency responsible for the given moratorium.

Work within a designated trout watershed of North Carolina (as identified by the Wilmington District of the US Army Corps of Engineers), or identified state or federal endangered or threatened species habitat, shall be coordinated with the appropriate WRC, USFWS, NMFS, and/or DMF personnel.

*Citation: 15A NCAC 02H .0506(b); 15A NCAC 02H .0507(c); 15A NCAC 04B .0125*

*Justification: In order to protect against impairment of water quality standards and best usage of receiving and downstream waters, water quality based management practices must be employed to protect against direct or indirect discharge of waste or other sources of water pollution. Surface water quality standards require that conditions of waters be suitable for all best uses provided for in state rule (including, at minimum: aquatic life propagation, survival, and maintenance of biological integrity, wildlife, secondary contact recreation, agriculture), and that activities must not cause water pollution that precludes any best use on a short-term or long-term basis.*

10. In-stream structures installed to mimic natural channel geomorphology such as cross-vanes, sills, step-pool structures, etc. shall be designed and installed in such a manner that allow for continued aquatic life movement.

*Citation: 15A NCAC 02H .0506(b); 15A NCAC 02H .0507(c)*

*Justification: Surface water quality standards require that conditions of waters be suitable for all best uses provided for in state rule, and that activities must not cause water pollution that precludes any best use on a short-term or long-term basis. Ensuring that in-stream structures are installed properly will ensure that surface water quality standards are met and conditions of waters are suitable for all best uses.*

11. Culverts shall be designed and installed in such a manner that the original stream profiles are not altered and allow for aquatic life movement during low flows. The dimension, pattern, and profile of the stream above and below a pipe or culvert shall not be modified by widening the stream channel or by reducing the depth of the stream in connection with the construction activity. The width, height, and gradient of a proposed culvert shall be such as to pass the average historical low flow and spring flow without adversely altering flow velocity. If the width of the culvert is wider than the stream channel, the culvert shall include multiple boxes/pipes, baffles, benches and/or sills to maintain the natural width of the stream channel. If multiple culverts/pipes/barrels are used, low flows shall be



## GC4239

accommodated in one culvert/pipe and additional culverts/pipes shall be installed such that they receive only flows above bankfull.

Placement of culverts and other structures in streams shall be below the elevation of the streambed by one foot for all culverts with a diameter greater than 48 inches, and 20% of the culvert diameter for culverts having a diameter less than or equal to 48 inches, to allow low flow passage of water and aquatic life. If the culvert outlet is submerged within a pool or scour hole and designed to provide for aquatic passage, then culvert burial into the streambed is not required.

For structures less than 72" in diameter/width, and topographic constraints indicate culvert slopes of greater than 2.5% culvert burial is not required, provided that all alternative options for flattening the slope have been investigated and aquatic life movement/connectivity has been provided when possible (e.g. rock ladders, cross-vanes, sills, baffles etc.). Notification, including supporting documentation to include a location map of the culvert, culvert profile drawings, and slope calculations, shall be provided to DWR 30 calendar days prior to the installation of the culvert.

When bedrock is present in culvert locations, culvert burial is not required, provided that there is sufficient documentation of the presence of bedrock. Notification, including supporting documentation such as a location map of the culvert, geotechnical reports, photographs, etc. shall be provided to DWR a minimum of 30 calendar days prior to the installation of the culvert. If bedrock is discovered during construction, then DWR shall be notified by phone or email within 24 hours of discovery.

Installation of culverts in wetlands shall ensure continuity of water movement and be designed to adequately accommodate high water or flood conditions. When roadways, causeways, or other fill projects are constructed across FEMA-designated floodways or wetlands, openings such as culverts or bridges shall be provided to maintain the natural hydrology of the system as well as prevent constriction of the floodway that may result in destabilization of streams or wetlands.

The establishment of native woody vegetation and other soft stream bank stabilization techniques shall be used where practicable instead of rip-rap or other bank hardening methods.

*Citation: 15A NCAC 02H .0506(b); 15A NCAC 02H .0507(c)*

*Justification: Surface water quality standards require that conditions of waters be suitable for all best uses provided for in state rule, and that activities must not cause water pollution that precludes any best use on a short-term or long-term basis. Ensuring that in-stream structures are installed properly will ensure that surface water quality standards are met and conditions of waters are suitable for all best uses.*

12. Bridge deck drains shall not discharge directly into the stream. Stormwater shall be directed across the bridge and pre-treated through site-appropriate means to the maximum

## GC4239

extent practicable (e.g. grassed swales, pre-formed scour holes, vegetated buffers, etc.) before entering the stream.

*Citation: 15A NCAC 02H .0506(b); 15A NCAC 02H .0507(c)*

*Justification: Surface water quality standards require that conditions of waters be suitable for all best uses provided for in state rule and that activities must not cause water pollution that precludes any best use on a short-term or long-term basis. Ensuring that in-stream structures are installed properly will ensure that surface water quality standards are met and conditions of waters are suitable for all best uses.*

13. Application of fertilizer to establish planted/seeded vegetation within disturbed riparian areas and/or wetlands shall be conducted at agronomic rates and shall comply with all other Federal, State and Local regulations. Fertilizer application shall be accomplished in a manner that minimizes the risk of contact between the fertilizer and surface waters.

*Citation: 15A 02H .0506(b); 15A NCAC 02H .0507(c); 15A NCAC 02B .0231*

*Justification: A project that affects waters shall not be permitted unless the existing uses, and the water quality to protect such uses, are protected. Activities must not cause water pollution that precludes any best use on a short-term or long-term basis. As cited in Stream Standards: (2) Oils, deleterious substances, or colored or other wastes: only such amounts as shall not render the waters injurious to public health, secondary recreation, or to aquatic life and wildlife, or adversely affect the palatability of fish, aesthetic quality, or impair the waters for any designated uses.*

14. If concrete is used during construction, then all necessary measures shall be taken to prevent direct contact between uncured or curing concrete and waters of the state. Water that inadvertently contacts uncured concrete shall not be discharged to waters of the state.

*Citation: 15A 02H .0506(b); 15A NCAC 02H .0507(c); 15A NCAC 02B .0200*

*Justification: A project that affects waters shall not be permitted unless the existing uses, and the water quality to protect such uses, are protected. Activities must not cause water pollution that precludes any best use on a short-term or long-term basis. As cited in Stream Standards: (2) Oils, deleterious substances, or colored or other wastes: only such amounts as shall not render the waters injurious to public health, secondary recreation, or to aquatic life and wildlife, or adversely affect the palatability of fish, aesthetic quality, or impair the waters for any designated uses.*

15. All proposed and approved temporary fill and culverts shall be removed and the impacted area shall be returned to natural conditions within 60 calendar days after the temporary impact is no longer necessary. The impacted areas shall be restored to original grade, including each stream's original cross-sectional dimensions, planform pattern, and longitudinal bed profile. All temporarily impacted sites shall be restored and stabilized with native vegetation.

*Citation: 15A NCAC 02H.0506(b); 15A NCAC 02H .0507(c)*

## GC4239

*Justification: A project that affects waters shall not be permitted unless the existing uses, and the water quality to protect such uses, are protected. Protections are necessary to ensure any remaining surface waters or wetlands, and any surface waters or wetlands downstream, continue to support existing uses after project completion.*

16. All proposed and approved temporary pipes/culverts/rip-rap pads etc. in streams shall be installed as outlined in the most recent edition of the *North Carolina Sediment and Erosion Control Planning and Design Manual* or the *North Carolina Surface Mining Manual* or the *North Carolina Department of Transportation Best Management Practices for Construction and Maintenance Activities* so as not to restrict stream flow or cause dis-equilibrium during use of this General Certification.

*Citation: 15A NCAC 02H .0506(b); 15A NCAC 02H .0507(c)*

*Justification: Surface water quality standards require that conditions of waters be suitable for all best uses provided for in state rule, and that activities must not cause water pollution that precludes any best use on a short-term or long-term basis. Ensuring that in-stream structures are installed properly will ensure that surface water quality standards are met and conditions of waters are suitable for all best uses.*

17. Any rip-rap required for proper culvert placement, stream stabilization, or restoration of temporarily disturbed areas shall be restricted to the area directly impacted by the approved construction activity. All rip-rap shall be placed such that the original streambed elevation and streambank contours are restored and maintained and shall consist of clean rock or masonry material free of debris or toxic pollutants. Placement of rip-rap or other approved materials shall not result in de-stabilization of the stream bed or banks upstream or downstream of the area or be installed in a manner that precludes aquatic life passage.

*Citation: 15A NCAC 02H .0506(b); 15A NCAC 02H .0507(c)*

*Justification: Surface water quality standards require that conditions of waters be suitable for all best uses provided for in state rule, and that activities must not cause water pollution that precludes any best use on a short-term or long-term basis. The Division must evaluate if the activity has avoided and minimized impacts to waters, would cause or contribute to a violation of standards, or would result in secondary or cumulative impacts.*

18. Any rip-rap used for stream or shoreline stabilization shall be of a size and density to prevent movement by wave, current action, or stream flows, and shall consist of clean rock or masonry material free of debris or toxic pollutants. Rip-rap shall not be installed in the streambed except in specific areas required for velocity control and to ensure structural integrity of bank stabilization measures.

*Citation: 15A NCAC 02H .0506(b); 15A NCAC 02H .0507(c); 15A NCAC 02B .0201*

*Justification: Surface water quality standards require that conditions of waters be suitable for all best uses provided for in state rule, and that activities must not cause water pollution that precludes any best use on a short-term or long-term basis. The Division must evaluate if the activity has avoided and minimized impacts to waters, would cause or contribute to a violation of standards, or would result in secondary or cumulative impacts.*

## GC4239

19. Rip-rap groins proposed in accordance with 15A NCAC 07H .1401 (NC Division of Coastal Management General Permit for construction of Wooden and Rip-rap Groins in Estuarine and Public Trust Waters) shall meet all the specific conditions for design and construction specified in 15A NCAC 07H .1405.

*Citation: 15A NCAC 02H .0507(c); 15A NCAC 07H .1400 et seq.*

*Justification: Surface water quality standards require that conditions of waters be suitable for all best uses provided for in state rule, and that activities must not cause water pollution that precludes any best use on a short-term or long-term basis. The Division must evaluate if the activity has avoided and minimized impacts to waters, would cause or contribute to a violation of standards, or would result in secondary or cumulative impacts.*

20. All mechanized equipment operated near surface waters shall be inspected and maintained regularly to prevent contamination of surface waters from fuels, lubricants, hydraulic fluids, or other toxic materials. Construction shall be staged in order to minimize the exposure of equipment to surface waters to the maximum extent practicable. Fueling, lubrication, and general equipment maintenance shall be performed in a manner to prevent, to the maximum extent practicable, contamination of surface waters by fuels and oils.

*Citation: 15A NCAC 02H .0506(b); 15A NCAC 02H .0507(c); 15A NCAC 02B .0200*

*Justification: A project that affects waters shall not be permitted unless the existing uses, and the water quality to protect such uses, are protected. Activities must not cause water pollution that precludes any best use on a short-term or long-term basis. As cited in Stream Standards: (2) Oils, deleterious substances, or colored or other wastes: only such amounts as shall not render the waters injurious to public health, secondary recreation, or to aquatic life and wildlife, or adversely affect the palatability of fish, aesthetic quality, or impair the waters for any designated uses.*

21. Heavy equipment working in wetlands shall be placed on mats or other measures shall be taken to minimize soil disturbance and compaction.

*Citation: 15A NCAC 02H .0506(b); 15A NCAC 02H .0507(c); 15A NCAC 02B .0231*

*Justification: Wetland standards require maintenance or enhancement of existing uses of wetlands such that hydrologic conditions necessary to support natural biological and physical characteristics are protected; populations of wetland flora and fauna are maintained to protect biological integrity of the wetland; and materials or substances are not present in amounts that may cause adverse impact on existing wetland uses.*

22. In accordance with 143-215.85(b), the permittee shall report any petroleum spill of 25 gallons or more; any spill regardless of amount that causes a sheen on surface waters; any petroleum spill regardless of amount occurring within 100 feet of surface waters; and any petroleum spill less than 25 gallons that cannot be cleaned up within 24 hours.

*Citation: 15A NCAC 02H .0507(c); N.C.G.S 143-215.85(b)*

*Justification: Person(s) owning or having control over oil or other substances upon notice of discharge must immediately notify the Department, or any of its agents or employees, of the*

## GC4239

*nature, location, and time of the discharge and of the measures which are being taken or are proposed to be taken to contain and remove the discharge. This action is required in order to contain or divert the substances to prevent entry into the surface waters. Surface water quality standards require that conditions of waters be suitable for all best uses provided for in state rule (including, at minimum: aquatic life propagation, survival, and maintenance of biological integrity; wildlife; secondary contact recreation; agriculture); and that activities must not cause water pollution that precludes any best use on a short-term or long-term basis.*

23. The permittee and their authorized agents shall conduct all activities in a manner consistent with State water quality standards (including any requirements resulting from compliance with §303(d) of the Clean Water Act), and any other appropriate requirements of State and Federal Law.

*Citation: 15A NCAC 02H .0506(b); 15A NCAC 02H .0507(c)*

*Justification: Surface water quality standards require that conditions of waters be suitable for all best uses provided for in state rule, and that activities must not cause water pollution that precludes any best use on a short-term or long-term basis. The Division must evaluate if the activity has avoided and minimized impacts to waters, would cause or contribute to a violation of standards, or would result in secondary or cumulative impacts.*

24. The permittee shall require its contractors and/or agents to comply with the terms and conditions of this permit in the construction and maintenance of this project, and shall provide each of its contractors and/or agents associated with the construction or maintenance of this project with a copy of this General Certification. A copy of this General Certification shall be available at the project site during the construction and maintenance of this project.

*Citation: 15A NCAC 02H .0506(b); 15A NCAC 02H .0507(c)*

*Justification: Those actually performing the work should be aware of the requirements of this 401 Water Quality General Certification to minimize water quality impacts.*

*History Note: Water Quality Certification (WQC) Number 4239 issued December 18, 2020 replaces WQC 4132 issued December 1, 2017 for activities eligible for USACE NWP3; WQC 3883 issued March 19, 2012; WQC 3687 issued November 1, 2007; WQC 3624 issued March 19, 2007; WQC 3494 issued December 31, 2004; and WQC 3376 issued March 18, 2002.*



North Carolina Department of Transportation  
 Highway Stormwater Program  
**STORMWATER MANAGEMENT PLAN**  
 FOR NCDOT PROJECTS



(Version 3.00; Released August 2021)

WBS Element: 46024.1.1      TIP/Proj No: B-5310      County(ies): Sampson      Page 1 of 2

**General Project Information**

WBS Element:	46024.1.1	TIP Number:	B-5310	Project Type:	Bridge Replacement	Date:	12/14/2022
NCDOT Contact:	Eric Murray			Contractor / Designer:	W. Herbert Turner, Jr., PE		
	Address:	Highway Division 3 5501 Barbados Blvd. Castle Hayne, NC 28429			Address:	Mott MacDonald 7621 Purfoy Rd, Suite 115 Fuquay Varina, NC 27526	
	Phone:	(910) 341-2000			Phone:	(919) 679-9379	
	Email:	<a href="mailto:ecmurray@ncdot.gov">ecmurray@ncdot.gov</a>			Email:	<a href="mailto:herb.turner@mottmac.com">herb.turner@mottmac.com</a>	
City/Town:	Newton Grove, NC			County(ies):	Sampson		
River Basin(s):	Cape Fear			CAMA County?	No		
Wetlands within Project Limits?	Yes						

**Project Description**

Project Length (lin. miles or feet):	0.104 miles	Surrounding Land Use:	Rural - Woods / Wetlands all quads					
	<b>Proposed Project</b>			<b>Existing Site</b>				
Project Built-Upon Area (ac.)	0.4	ac.	0.3	ac.				
Typical Cross Section Description:	Bradshaw Rd (SR 1817): 2 paved lanes (total 20' wide), 6' paved shoulders w guardrail			Bradshaw Rd (SR 1817): 2 paved lanes (total 20' wide), grass shoulders on each side				
Annual Avg Daily Traffic (veh/hr/day):	Design/Future:	640	Year:	2040	Existing:	320	Year:	2018

**General Project Narrative:  
 (Description of Minimization of Water  
 Quality Impacts)**

The North Carolina Department of Transportation (NCDOT) proposes to replace Bridge No. 188 on Bradshaw Road (SR 1817) over Ward Swamp in Sampson County. There are no buffers present on this project; however, there are wetlands and jurisdictional waters.

The existing structure is a 3-span bridge (1@30'-6", 1@30'-0", 1@30'-6") and is a prestressed concrete channel structure. The proposed structure is 2-spans (2 @ 55'-0") with 21" prestressed concrete cored slab units and 4' deep caps. This structure has been designed to minimize environmental and surface water impacts, to the extent possible. Class II rip rap with geotextile fabric was added for abutment stabilization. To avoid direct discharge of bridge storm water into the receiving water, the bridge was designed to discharge outside of open waters.

Storm water impacts to the stream have been minimized by utilizing grated inlets with shoulder berm gutter and outlet pipes to wetlands. Rip rap outlet protection was added to dissipate energy to provide non erosive velocities into wetlands in all quadrants of the project. The roadway is in a fill section with runoff sheet flowing off the pavement into adjacent wetlands to remove pollutants via infiltration and settling.

Due to the nature of low impact bridge replacement, the increases in stormwater discharges (post v. pre condition) are insignificant. Therefore, additional stormwater measures are not required.

4/25/2023



North Carolina Department of Transportation  
 Highway Stormwater Program  
**STORMWATER MANAGEMENT PLAN**  
 FOR NCDOT PROJECTS



(Version 3.00; Released August 2021)

WBS Element: 46024.1.1      TIP/Proj No.: B-5310      County(ies): Sampson      Page 2 of 2

**General Project Information**

**Waterbody Information**

<b>Surface Water Body (1):</b>		Ward Swamp		<b>NCDWR Stream Index No.:</b>		18-68-1-4	
<b>NCDWR Surface Water Classification for Water Body</b>			<b>Primary Classification:</b>		Class C		
			<b>Supplemental Classification:</b>		Swamp Waters (Sw)		
<b>Other Stream Classification:</b>		None					
<b>Impairments:</b>		None					
<b>Aquatic T&amp;E Species?</b>		No		<b>Comments:</b>			
<b>NRTR Stream ID:</b>		Ward Swamp		<b>Buffer Rules in Effect:</b>		N/A	
<b>Project Includes Bridge Spanning Water Body?</b>		Yes		<b>Deck Drains Discharge Over Buffer?</b>		N/A	
<b>Deck Drains Discharge Over Water Body?</b>		No		(If yes, provide justification in the General Project Narrative)		<b>Dissipator Pads Provided in Buffer?</b>	
(If yes, provide justification in the General Project Narrative)						(If yes, describe in the General Project Narrative; if no, justify in the General Project Narrative)	
<b>Surface Water Body (2):</b>				<b>NCDWR Stream Index No.:</b>			
<b>NCDWR Surface Water Classification for Water Body</b>			<b>Primary Classification:</b>				
			<b>Supplemental Classification:</b>				
<b>Other Stream Classification:</b>							
<b>Impairments:</b>							
<b>Aquatic T&amp;E Species?</b>				<b>Comments:</b>			
<b>NRTR Stream ID:</b>				<b>Buffer Rules in Effect:</b>			
<b>Project Includes Bridge Spanning Water Body?</b>				<b>Deck Drains Discharge Over Buffer?</b>			
<b>Deck Drains Discharge Over Water Body?</b>				(If yes, provide justification in the General Project Narrative)		<b>Dissipator Pads Provided in Buffer?</b>	
(If yes, provide justification in the General Project Narrative)						(If yes, describe in the General Project Narrative; if no, justify in the General Project Narrative)	
<b>Surface Water Body (3):</b>				<b>NCDWR Stream Index No.:</b>			
<b>NCDWR Surface Water Classification for Water Body</b>			<b>Primary Classification:</b>				
			<b>Supplemental Classification:</b>				
<b>Other Stream Classification:</b>							
<b>Impairments:</b>							
<b>Aquatic T&amp;E Species?</b>				<b>Comments:</b>			
<b>NRTR Stream ID:</b>				<b>Buffer Rules in Effect:</b>			
<b>Project Includes Bridge Spanning Water Body?</b>				<b>Deck Drains Discharge Over Buffer?</b>			
<b>Deck Drains Discharge Over Water Body?</b>				(If yes, provide justification in the General Project Narrative)		<b>Dissipator Pads Provided in Buffer?</b>	
(If yes, provide justification in the General Project Narrative)						(If yes, describe in the General Project Narrative; if no, justify in the General Project Narrative)	

4/25/2023

4/25/2023

TIP PROJECT: B-5310

CONTRACT:

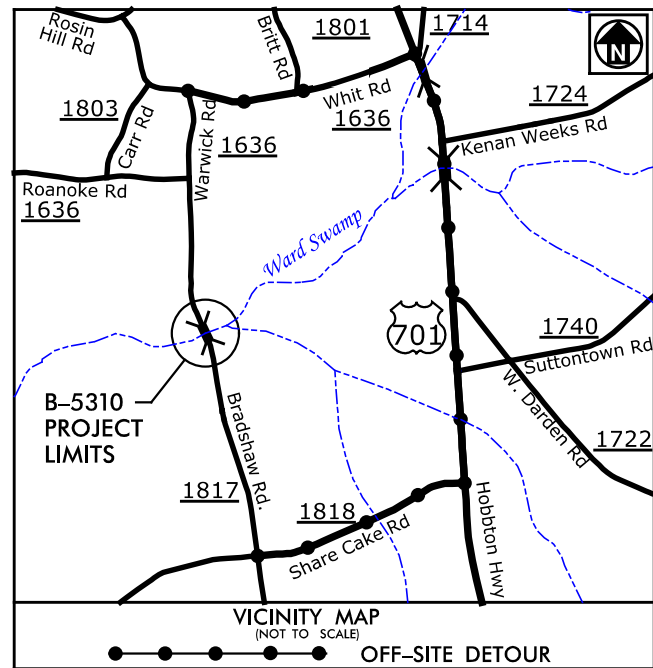

See Sheet 1A For Index of Sheets,  
See Sheet 1B For Conventional Symbols

STATE OF NORTH CAROLINA  
DIVISION OF HIGHWAYS  
**SAMPSON COUNTY**

LOCATION: BRIDGE NO. 188 OVER WARD SWAMP ON  
SR 1817 (BRADSHAW ROAD)

TYPE OF WORK: GRADING, PAVING, DRAINAGE AND STRUCTURE

WETLAND AND SURFACE WATER IMPACTS PERMIT

STATE	STATE PROJECT REFERENCE NO.	SHEET NO.	TOTAL SHEETS
N.C.	B-5310	1	
STATE PROJECT NO.	F.A. PROJ. NO.	DESCRIPTION	
46024.1.1	BRZ-1817(001)	PE	
46024.2.1	BRZ-1817(001)	R/W, UTL	
46024.3.1	BRZ-1817(001)	CONST	

PERMIT DRAWING  
SHEET 1 OF 8

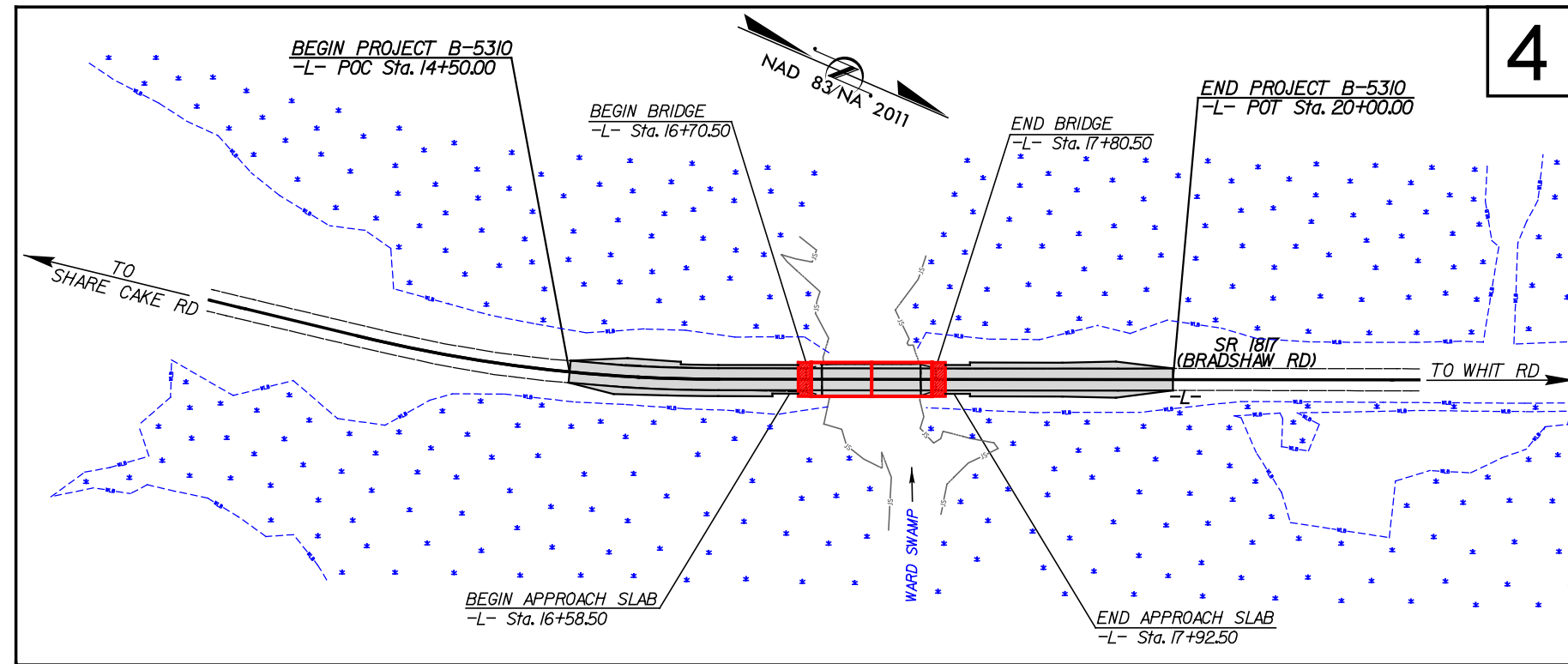

THIS PROJECT IS NOT WITHIN ANY MUNICIPAL BOUNDARIES.  
CLEARING ON THIS PROJECT SHALL BE PERFORMED TO THE LIMITS ESTABLISHED BY MODIFIED METHOD III.

DOCUMENT NOT CONSIDERED FINAL  
UNLESS ALL SIGNATURES COMPLETED

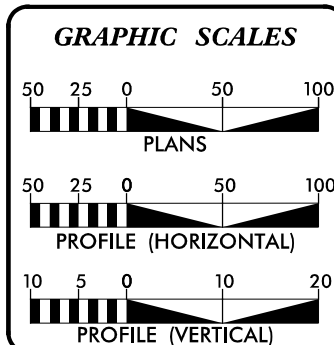

**DESIGN DATA**

ADT 2023 =	280
ADT 2045 =	500
K =	TBD
D =	TBD
T =	TBD
V =	55 MPH
* TTST N/A	DUAL N/A
FUNC CLASS =	SUB REGIONAL TIER
LOCAL	

**PROJECT LENGTH**

LENGTH ROADWAY TIP PROJECT	=	0.083 MILES
LENGTH STRUCTURE TIP PROJECT	=	0.021 MILES
TOTAL LENGTH TIP PROJECT	=	0.104 MILES

PLANS PREPARED FOR THE NCDOT BY:

**M M**  
MOTT  
MACDONALD  
2018 STANDARD SPECIFICATIONS

7621 Purfoy Road, Suite 115  
Fuquay-Varina, NC 27526  
(919) 552-2253  
(919) 552-2254 (Fax)  
www.mottmac.com/americas  
LICENSE NO. F-0669

RIGHT OF WAY DATE:  
JANUARY 22, 2023

LETTING DATE:  
JANUARY 24, 2024

TIM JORDAN, PE  
PROJECT ENGINEER

PADDY JORDAN  
PROJECT DESIGN ENGINEER

DEREK PIELECH, PE  
NCDOT CONTACT  
DIVISION BRIDGE  
PROGRAM MANAGER

ROADWAY DESIGN ENGINEER

SIGNATURE: \_\_\_\_\_ P.E.

HYDRAULICS ENGINEER

SIGNATURE: \_\_\_\_\_ P.E.

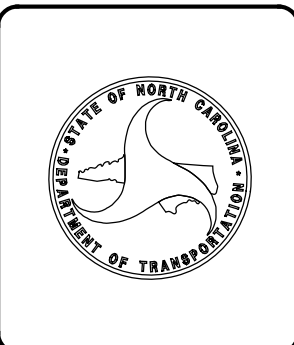

2/10/2023  
MOTT MACDONALD  
R:\Hydraulics\PERMITS\Environmental\Drawings\B5310\_prm\_wef\_tsh.dgn



4/25/2023

PROJECT REFERENCE		SHEET NO.	
B-5310		4	
ROADWAY DESIGN ENGINEER		HYDRAULICS ENGINEER	
MOTT MACDONALD I & E, LLC LICENSE NO. F-0669		MOTT MACDONALD I & E, LLC LICENSE NO. F-0669	
<b>DOCUMENT NOT CONSIDERED FINAL UNLESS ALL SIGNATURES COMPLETED</b>			
Prepared in the Office of:		<b>M</b> MOTT MACDONALD I & E, LLC 7621 Purfoy Road, Suite 115 Fuquay-Varina, NC 27526 www.mottmac.com	
GRAPHIC SCALE 25' 0 25' 50'			
PERMIT DRAWING SHEET 2 OF 8			ENGLISH

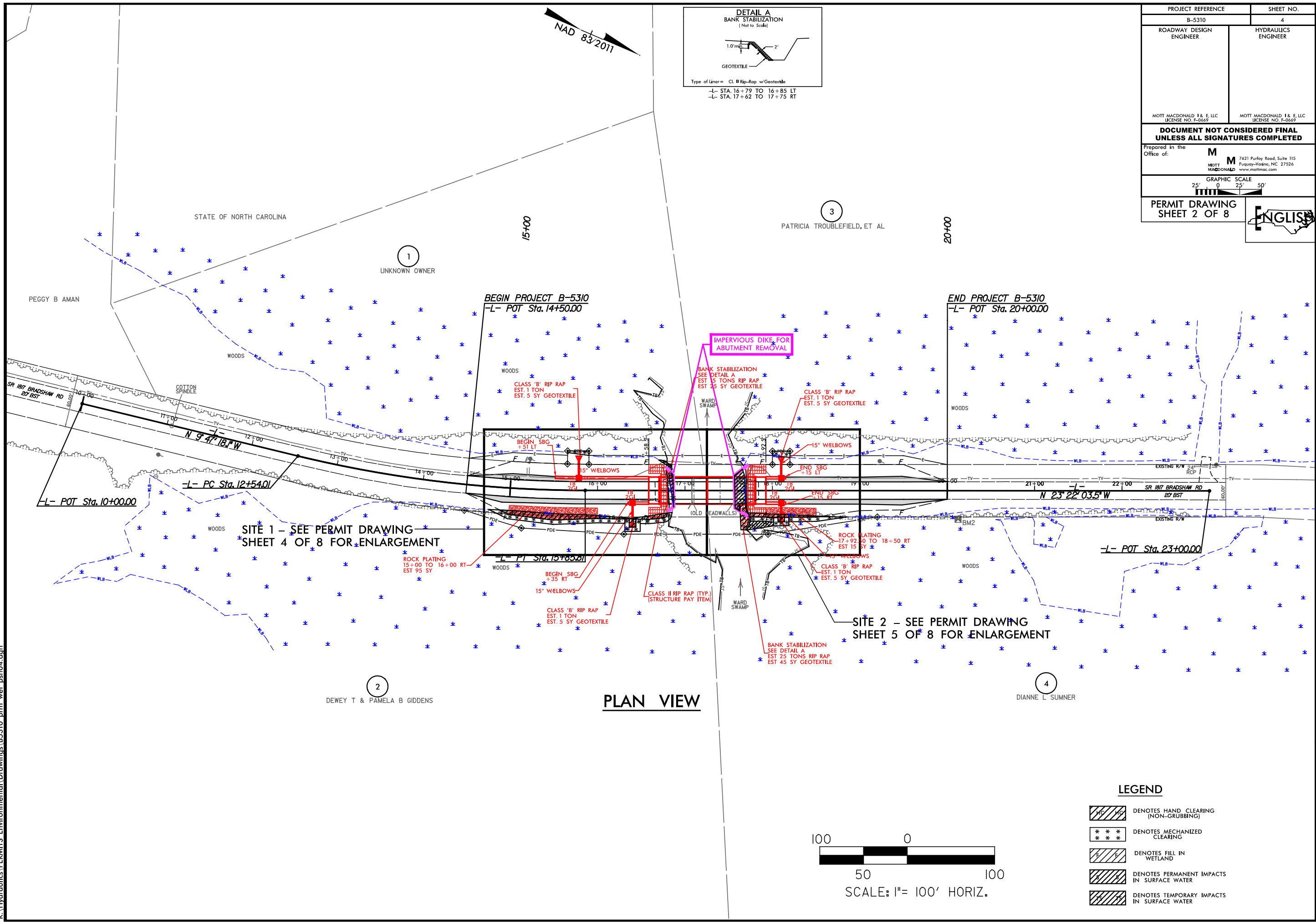
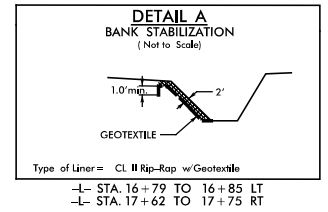

PLAN VIEW

**LEGEND**

	DENOTES HAND CLEARING (NON-GRUBBING)
	DENOTES MECHANIZED CLEARING
	DENOTES FILL IN WETLAND
	DENOTES PERMANENT IMPACTS IN SURFACE WATER
	DENOTES TEMPORARY IMPACTS IN SURFACE WATER

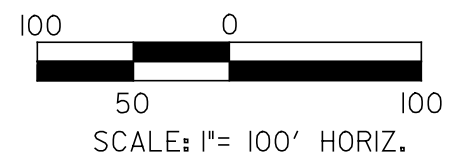

2/10/2023  
 MOTT MACDONALD  
 R:\Hydraulics\PERMITS\Environmental\Drawings\B5310\_prm\_wet\_psh04.dgn

4/25/2023

PROJECT REFERENCE		SHEET NO.	
B-5310		4	
ROADWAY DESIGN ENGINEER		HYDRAULICS ENGINEER	
MOTT MACDONALD I & E, LLC LICENSE NO. F-0669		MOTT MACDONALD I & E, LLC LICENSE NO. F-0669	
<b>DOCUMENT NOT CONSIDERED FINAL UNLESS ALL SIGNATURES COMPLETED</b>			
Prepared in the Office of:			
MOTT MACDONALD		MOTT MACDONALD I & E, LLC 7621 Purfoy Road, Suite 115 Fayetteville, NC 27526 www.mottmac.com	
GRAPHIC SCALE 25' 0 25' 50'			
PERMIT DRAWING SHEET 3 OF 8			ENGLISH

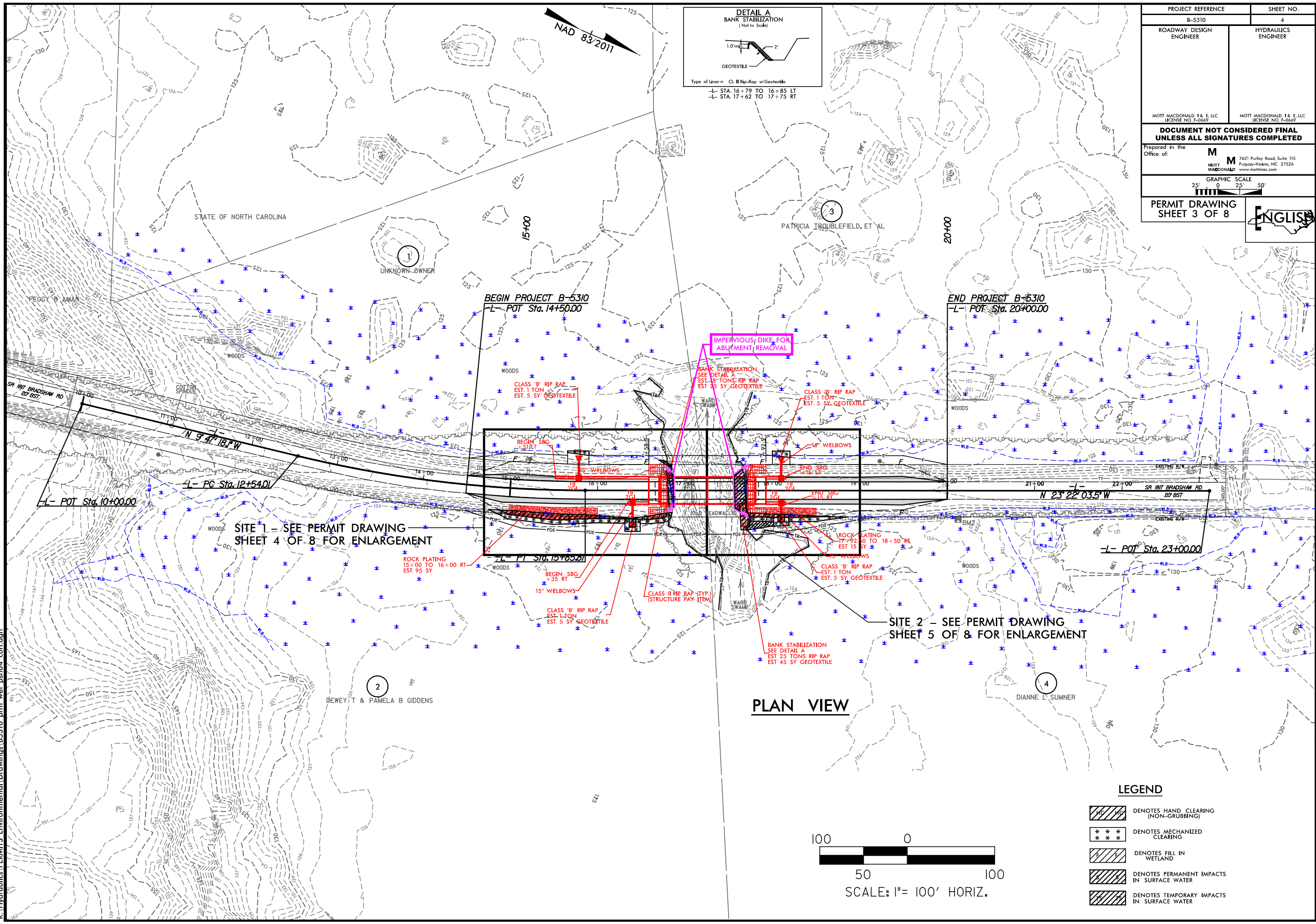
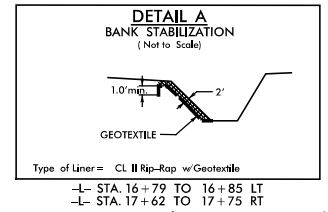

2/10/2023  
MOTT MACDONALD  
R:\Hydraulics\PERMITS\Environmental\Drawings\B5310\_prm\_wet\_psh04\_con.dgn

**PLAN VIEW**



**LEGEND**

	DENOTES HAND CLEARING (NON-GRUBBING)
	DENOTES MECHANIZED CLEARING
	DENOTES FILL IN WETLAND
	DENOTES PERMANENT IMPACTS IN SURFACE WATER
	DENOTES TEMPORARY IMPACTS IN SURFACE WATER

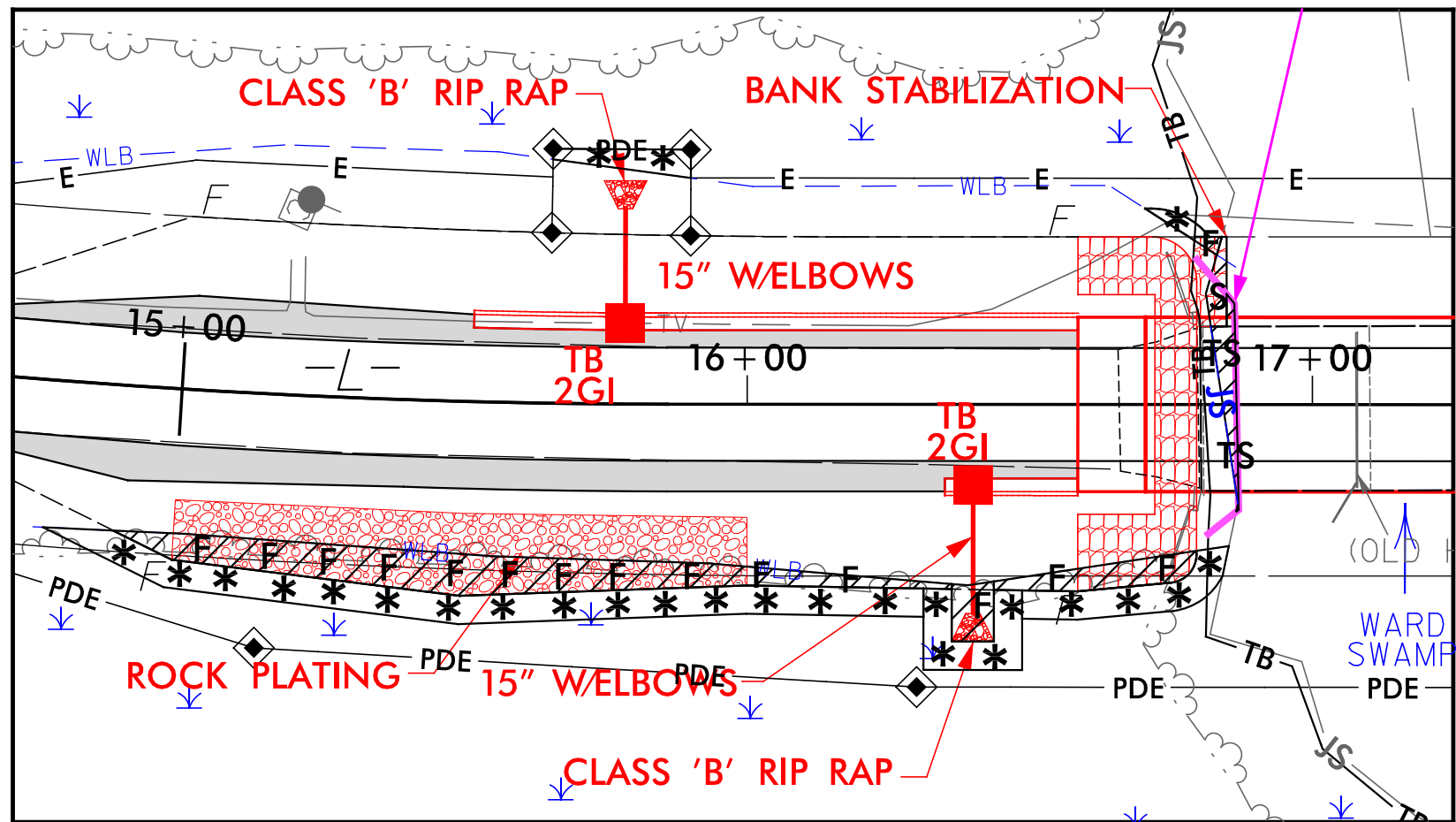

4/25/2023

PROJECT REFERENCE		SHEET NO.	
B-5310		4A	
ROADWAY DESIGN ENGINEER		HYDRAULICS ENGINEER	
MOTT MACDONALD I & E, LLC LICENSE NO. F-0669		MOTT MACDONALD I & E, LLC LICENSE NO. F-0669	
<b>DOCUMENT NOT CONSIDERED FINAL UNLESS ALL SIGNATURES COMPLETED</b>			
Prepared in the Office of:		MOTT MACDONALD I & E, LLC 7621 Purfoy Road, Suite 115 Fuquay-Varina, NC 27526 www.mottmac.com	
PERMIT DRAWING SHEET 4 OF 8		ENGLISH	



**SITE 1  
ENLARGED PLAN**

**LEGEND**

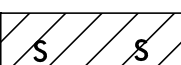
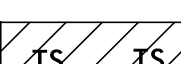
- 
DENOTES MECHANIZED CLEARING
- 
DENOTES FILL IN WETLAND
- 
DENOTES PERMANENT IMPACTS IN SURFACE WATER
- 
DENOTES TEMPORARY IMPACTS IN SURFACE WATER

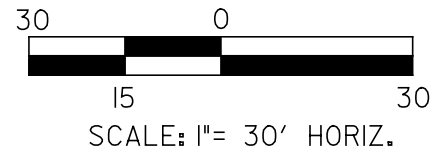

2/10/2023  
 MOTT MACDONALD  
 R:\Hydraulics\PERMITS\_Environmental\Drawings\B5310\_prm\_wet\_psh04A.dgn

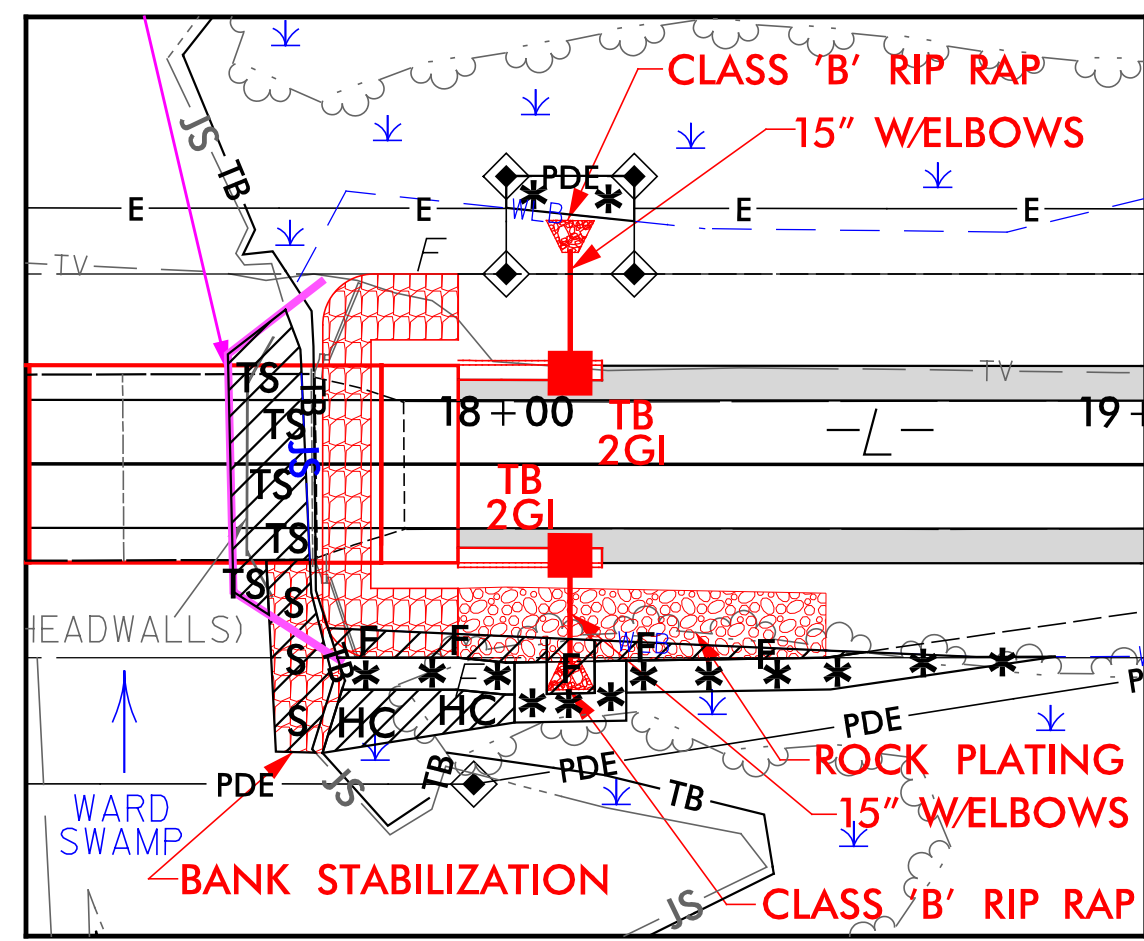

4/25/2023

PROJECT REFERENCE		SHEET NO.	
B-48310			
ROADWAY DESIGN ENGINEER		HYDRAULICS ENGINEER	
MOTT MACDONALD I & E, LLC LICENSE NO. F-06697		MOTT MACDONALD I & E, LLC LICENSE NO. F-06697	
<b>DOCUMENT NOT CONSIDERED FINAL UNLESS ALL SIGNATURES COMPLETED</b>			
Prepared in the Office of:		<b>M</b> MOTT MACDONALD 7621 Purfoy Road, Suite 115 Fuquay-Varina, NC 27526 www.mottmac.com	
GRAPHIC SCALE 25' 0 25' 50'			
PERMIT DRAWING SHEET 5 OF 8			

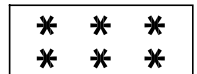

**SITE 2  
ENLARGED PLAN**

**LEGEND**

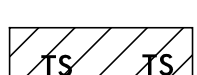
- 
 DENOTES HAND CLEARING (NON-GRUBBING)
- 
 DENOTES MECHANIZED CLEARING
- 
 DENOTES FILL IN WETLAND
- 
 DENOTES PERMANENT IMPACTS IN SURFACE WATER
- 
 DENOTES TEMPORARY IMPACTS IN SURFACE WATER



2/10/2023  
 MOTT MACDONALD  
 R:\Hydraulics\PERMITS\_Environmental\Drawings\B5310\_prm\_wet\_psh04B.dgn



4/25/2023

PROJECT REFERENCE B-5310	SHEET NO. 5
ROADWAY DESIGN ENGINEER	HYDRAULICS ENGINEER
MOTT MACDONALD I & E, LLC LICENSE NO. F-0669	MOTT MACDONALD I & E, LLC LICENSE NO. F-0669
<b>DOCUMENT NOT CONSIDERED FINAL UNLESS ALL SIGNATURES COMPLETED</b>	
Prepared in the Office of:	M M PO Box 700 Furqay-Vasito, NC 27526 www.mottmac.com/america
VERTICAL SCALE 5' 0 5' 10'	HORIZONTAL SCALE 25' 0 25' 50'
PERMIT DRAWING SHEET 6 OF 8	ENGLISH

-L-

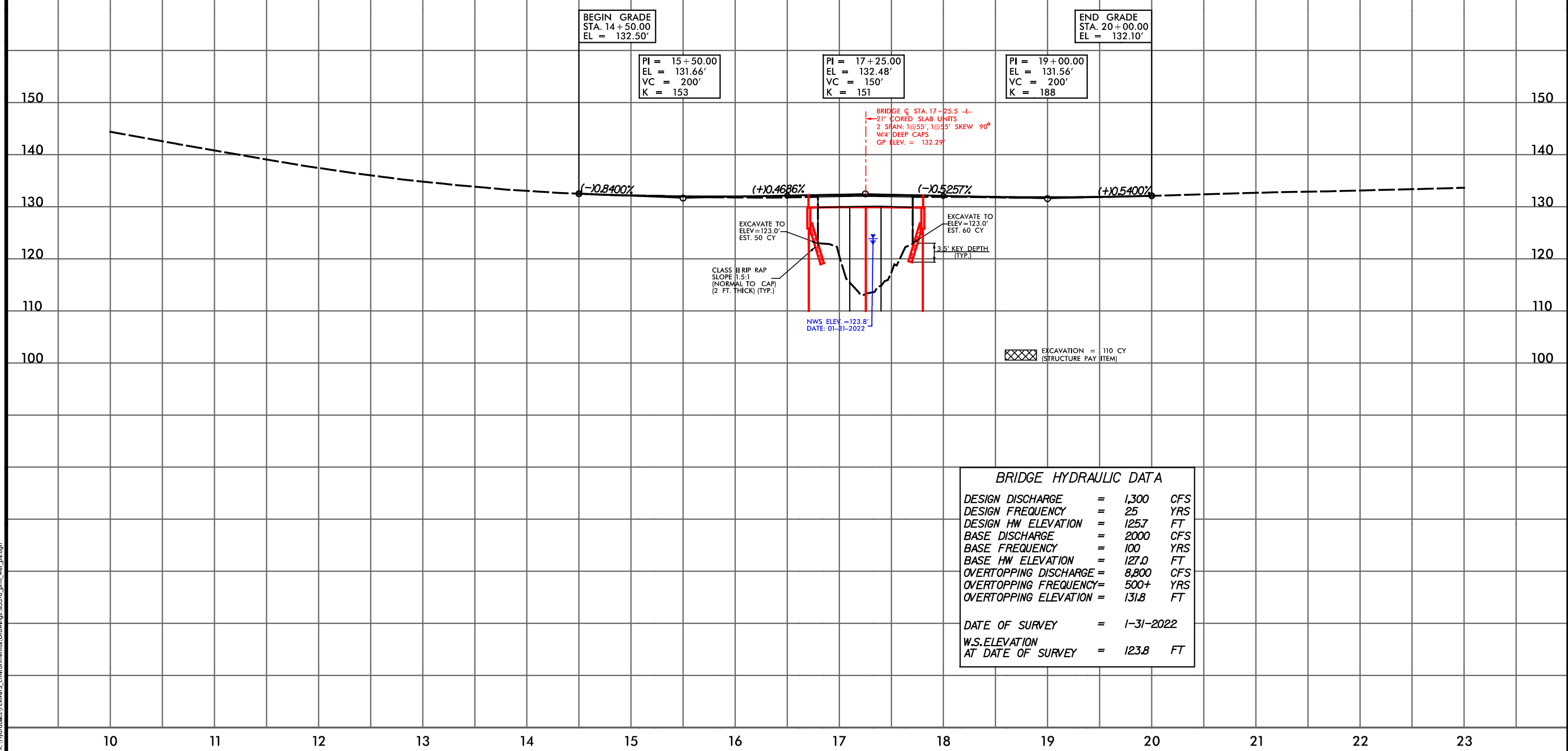

BRIDGE HYDRAULIC DATA		
DESIGN DISCHARGE	=	1,300 CFS
DESIGN FREQUENCY	=	25 YRS
DESIGN HW ELEVATION	=	125.7 FT
BASE DISCHARGE	=	2000 CFS
BASE FREQUENCY	=	100 YRS
BASE HW ELEVATION	=	127.0 FT
OVERTOPPING DISCHARGE	=	8,800 CFS
OVERTOPPING FREQUENCY	=	500+ YRS
OVERTOPPING ELEVATION	=	131.8 FT
DATE OF SURVEY	=	1-31-2022
W.S. ELEVATION AT DATE OF SURVEY	=	123.8 FT

2/10/2023  
MOTT MACDONALD  
R:\Hydraulics\PERMITS\_Environmental\Drawings\B5310\_perm\_vet.dgn

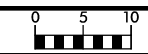

PROJECT REFERENCE	SHEET NO.
B-5310	X-2

150 140 130 120 110 100 90 80 70 60 50 40 30 20 10 0 10 20 30 40 50 60 70 80 90 100 110 120 130 140 150



**PERMIT DRAWING**  
**SHEET 7 OF 8**

**PRELIMINARY PLANS**  
DO NOT USE FOR CONSTRUCTION

**SITE 2**

← WETLAND →

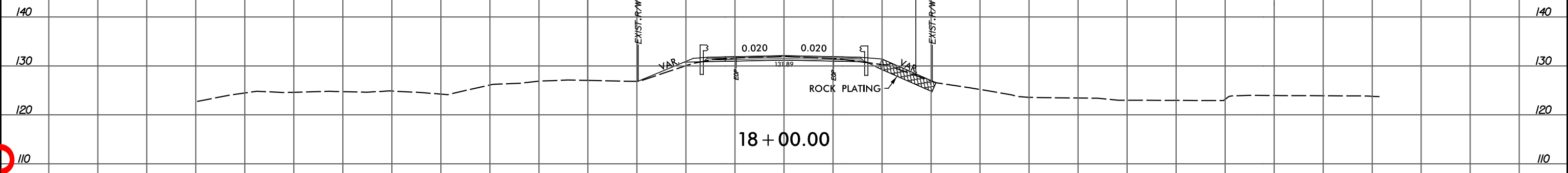

**SITE 1**

← WETLAND →

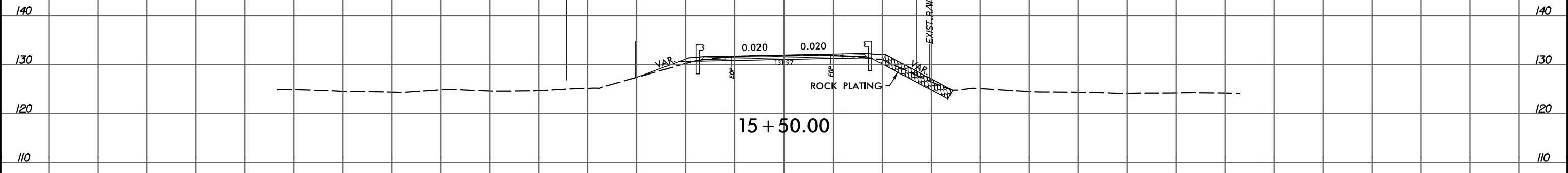

— 4 —

150 140 130 120 110 100 90 80 70 60 50 40 30 20 10 0 10 20 30 40 50 60 70 80 90 100 110 120 130 140 150

4/25/2023

2/10/2023  
JTT:MAC/PCV:MD  
R:\Hydro\BIS\PERMITS\Environmental Drawings\B5310\_perm\_swet\_spl.dgn

4/25/2023

**WETLAND AND SURFACE WATER IMPACTS SUMMARY**

Site No.	Station (From/To)	Structure Size / Type	WETLAND IMPACTS					SURFACE WATER IMPACTS				
			Permanent Fill In Wetlands (ac)	Temp. Fill In Wetlands (ac)	Excavation in Wetlands (ac)	Mechanized Clearing in Wetlands (ac)	Hand Clearing in Wetlands (ac)	Permanent SW impacts (ac)	Temp. SW impacts (ac)	Existing Channel Impacts Permanent (ft)	Existing Channel Impacts Temp. (ft)	Bank Stabilization (ft)
1	STA. 15+65 TO 15+90 LT.	15" w/ ELBOW OUTFALL				0.002						
	STA. 16+70 TO 16+85 LT.	BANK STABILIZATION	0.000			0.001		0.001				16
	STA. 14+77 TO 16+85 RT.	ROADWAY EMBANKMENT	0.021			0.026						
	STA. 16+82 TO 16+86	EXISTING BENT REMOVAL							0.002			
2	STA. 17+57 TO 17+69	EXISTING BENT REMOVAL							0.010			
	STA. 18+00 TO 18+20 LT.	15" w/ ELBOW OUTFALL				0.003						
	STA. 17+63 TO 17+73 RT.	BANK STABILIZATION						0.005				31
	STA. 17+71 TO 18+86 RT.	ROADWAY EMBANKMENT	0.008			0.019	0.005					
<b>TOTALS:</b>			<b>0.029</b>	<b>0.000</b>	<b>0.000</b>	<b>0.051</b>	<b>0.005</b>	<b>0.006</b>	<b>0.012</b>	<b>0</b>	<b>0</b>	<b>47</b>

NOTES:

NC DEPARTMENT OF TRANSPORTATION  
 DIVISION OF HIGHWAYS  
 FEBRUARY 21, 2023  
 SAMPSON COUNTY  
 TIP PROJECT: B-5310  
 46024.1.1

**LISTING OF DBE SUBCONTRACTORS**

Sheet of

Firm Name and Address	Item No.	Item Description	* Agreed upon Unit Price	** Dollar Volume of Item
<b>Name</b>  Address				
<b>Name</b>  Address				
<b>Name</b>  Address				
<b>Name</b>  Address				
<b>Name</b>  Address				
<b>Name</b>  Address				
<b>Name</b>  Address				

\* The Dollar Volume shown in this column shall be the Actual Price Agreed Upon by the Prime Contractor and the DBE subcontractor, and these prices will be used to determine the percentage of the DBE participation in the contract.

\*\* Dollar Volume of DBE Subcontractor Percentage of Total Contract Bid Price:

*If firm is a Material Supplier Only, show Dollar Volume as 60% of Agreed Upon Amount from Letter of Intent.*

*If firm is a Manufacturer, show Dollar Volume as 100% of Agreed Upon Amount from Letter of Intent.*



**LISTING OF DBE SUBCONTRACTORS**

Sheet of

Firm Name and Address	Item No.	Item Description	* Agreed upon Unit Price	** Dollar Volume of Item
<b>Name</b>  Address				
<b>Name</b>  Address				
<b>Name</b>  Address				
<b>Name</b>  Address				
<b>Name</b>  Address				

**\*\* Dollar Volume of DBE Subcontractor \$ \_\_\_\_\_**

**Percentage of Total Contract Bid Price \_\_\_\_\_%**

**\* The Dollar Volume shown in this column shall be the Actual Price Agreed Upon by the Prime Contractor and the DBE subcontractor, and these prices will be used to determine the percentage of the DBE participation in the contract.**

**\*\* Dollar Volume of DBE Subcontractor Percentage of Total Contract Bid Price:  
 If firm is a Material Supplier Only, show Dollar Volume as 60% of Agreed Upon Amount from Letter of Intent.  
 If firm is a Manufacturer, show Dollar Volume as 100% of Agreed Upon Amount from Letter of Intent.**

STATE OF NORTH CAROLINA  
DEPARTMENT OF TRANSPORTATION  
RALEIGH, NC

CONTRACT PAYMENT BOND

Date of Payment Bond Execution \_\_\_\_\_

Name of Principal Contractor \_\_\_\_\_

Name of Surety: \_\_\_\_\_

Name of Contracting Body: \_\_\_\_\_

Amount of Bond: \_\_\_\_\_

Contract ID No.: DC00459

County Name: Sampson County

KNOW ALL MEN BY THESE PRESENTS, That we, the PRINCIPAL CONTRACTOR (hereafter, PRINCIPAL) and SURETY above named, are held and firmly bound unto the above named Contracting Body, hereinafter called the Contracting Body, in the penal sum of the amount stated above for the payment of which sum well and truly to be made, we bind ourselves, our heirs, executors, administrators, and successors, jointly and severally, firmly by these presents.

THE CONDITION OF THIS OBLIGATION IS SUCH, that whereas the principal entered into a certain contract with the Contracting Body, numbered as shown above and hereto attached:

NOW THEREFORE, if the principal shall promptly make payment to all persons supplying labor and material in the prosecution of the work provided for in said contract, and any and all duly authorized modifications of said contract that may hereafter be made, notice of which modifications to the surety being hereby waived, then this obligation to be void; otherwise to remain in full force and virtue.

IN WITNESS WHEREOF, the above-bound parties have executed this instrument under their several seals on the date indicated above, the name and corporate seal of each corporate party being hereto affixed and these presents duly signed by its undersigned representative, pursuant to authority of its governing body.

**CONTRACT PAYMENT BOND**

*Affix Seal of Surety Company*

\_\_\_\_\_  
Print or type Surety Company Name

By \_\_\_\_\_  
Print, stamp or type name of Attorney-in-Fact

\_\_\_\_\_  
Signature of Attorney-in-Fact

\_\_\_\_\_  
Signature of Witness

\_\_\_\_\_  
Print or type Signer's name

\_\_\_\_\_  
Address of Attorney-in-Fact

**CONTRACT PAYMENT BOND  
CORPORATION**

SIGNATURE OF CONTRACTOR (Principal)

\_\_\_\_\_  
Full name of Corporation

\_\_\_\_\_  
Address as prequalified

By

\_\_\_\_\_  
**Signature** of President, Vice President, Assistant Vice President  
*Select appropriate title*

\_\_\_\_\_  
Print or type Signer's name

*Affix Corporate Seal*

Attest

\_\_\_\_\_  
**Signature** of Secretary, Assistant Secretary  
*Select appropriate title*

\_\_\_\_\_  
Print or type Signer's name

**CONTRACT PAYMENT BOND  
LIMITED LIABILITY COMPANY**

SIGNATURE OF CONTRACTOR (Principal)

Name of Contractor

\_\_\_\_\_

Full name of Firm

\_\_\_\_\_

Address as prequalified

By:

\_\_\_\_\_

**Signature** of Member, Manager, Authorized Agent  
*Select appropriate title*

\_\_\_\_\_

Print or type Signer's name

**CONTRACT PAYMENT BOND**

**INDIVIDUAL DOING BUSINESS UNDER A FIRM NAME**

SIGNATURE OF CONTRACTOR (Principal)

Name of Contractor

\_\_\_\_\_  
Individual Name

Trading and doing business as

\_\_\_\_\_  
Full name of Firm

\_\_\_\_\_  
Address as prequalified

Signature of Contractor

\_\_\_\_\_  
Individually

\_\_\_\_\_  
Print or type Signer's name

\_\_\_\_\_  
Signature of Witness

\_\_\_\_\_  
Print or type Signer's name

**CONTRACT PAYMENT BOND**

**INDIVIDUAL DOING BUSINESS IN HIS OWN NAME**

SIGNATURE OF CONTRACTOR (Principal)

Name of Contractor

\_\_\_\_\_

Print or type Individual name

\_\_\_\_\_

Address as prequalified

Signature of Contractor

\_\_\_\_\_

Individually

\_\_\_\_\_

Print or type Signer's name

\_\_\_\_\_  
Signature of Witness

\_\_\_\_\_  
Print or type Signer's name

**CONTRACT PAYMENT BOND  
PARTNERSHIP**

SIGNATURE OF CONTRACTOR (Principal)

---

Full name of Partnership

---

Address as prequalified

By

---

Signature of Partner

---

Print or type Signer's name

---

Signature of Witness

---

Print or type Signer's name



**CONTRACT PAYMENT BOND**  
**JOINT VENTURE (2) or (3)**  
SIGNATURE OF CONTRACTORS (Principal)

Instructions to Bidders: 2 Joint Ventures, Fill in lines (1), (2) and (3) and execute. 3 Joint Venturers Fill in lines (1), (2), (3), (4) and execute. On Line (1), print or type the name of Joint Venture. On line (2), print or type the name of one of the joint venturers and execute below in the appropriate manner required by Article 102-8 of the *NCDOT Standard Specifications*. On Line (3), print or type the name of second joint venturer and execute below in the appropriate manner required by said article of the Specifications. On Line (4), print or type the name of the third joint venturer, if applicable and execute below in the appropriate manner required by said article of the Specifications. This form of execution must be strictly followed.

(1) \_\_\_\_\_  
Name of Joint Venture

(2) \_\_\_\_\_  
Name of Contractor

\_\_\_\_\_  
Address as prequalified

\_\_\_\_\_  
Signature of Witness or Attest By \_\_\_\_\_  
Signature of Contractor

\_\_\_\_\_  
Print or type Signer's name \_\_\_\_\_  
Print or type Signer's name

*If Corporation, affix Corporate Seal*

and

(3) \_\_\_\_\_  
Name of Contractor

\_\_\_\_\_  
Address as prequalified

\_\_\_\_\_  
Signature of Witness or Attest By \_\_\_\_\_  
Signature of Contractor

\_\_\_\_\_  
Print or type Signer's name \_\_\_\_\_  
Print or type Signer's name

*If Corporation, affix Corporate Seal*

and

(4) \_\_\_\_\_  
Name of Contractor *(for 3 Joint Venture only)*

\_\_\_\_\_  
Address as prequalified

\_\_\_\_\_  
Signature of Witness or Attest By \_\_\_\_\_  
Signature of Contractor

\_\_\_\_\_  
Print or type Signer's name \_\_\_\_\_  
Print or type Signer's name

*If Corporation, affix Corporate Seal*

**CONTRACT PAYMENT BOND**

Attach certified copy of Power of Attorney to this sheet

STATE OF NORTH CAROLINA  
DEPARTMENT OF TRANSPORTATION  
RALEIGH, NC

CONTRACT PERFORMANCE BOND

Date of Performance Bond Execution: \_\_\_\_\_

Name of Principal Contractor: \_\_\_\_\_

Name of Surety: \_\_\_\_\_

Name of Contracting Body: \_\_\_\_\_

Amount of Bond: \_\_\_\_\_

Contract ID No.: DC00459

County Name: Sampson County

KNOW ALL MEN BY THESE PRESENTS, That we, the PRINCIPAL CONTRACTOR (hereafter, PRINCIPAL) and SURETY above named, are held and firmly bound unto the above named Contracting Body, hereinafter called the Contracting Body, in the penal sum of the amount stated above for the payment of which sum well and truly to be made, we bind ourselves, our heirs, executors, administrators, and successors, jointly and severally, firmly by these presents.

THE CONDITION OF THIS OBLIGATION IS SUCH, that whereas the principal entered into a certain contract with the Contracting Body, numbered as shown above and hereto attached:

NOW THEREFORE, if the principal shall well and truly perform and fulfill all the undertakings, covenants, terms, conditions, and agreements of said contract during the original term of said contract and any extensions thereof that may be granted by the Contracting Body, with or without notice to the Surety, and during the life of any guaranty required under the contract, and shall also well and truly perform and fulfill all the undertakings, covenants, terms, conditions, and agreements of any and all duly authorized modifications of said contract that may hereafter be made, notice of which modifications to the surety being hereby waived, then this obligation to be void; otherwise to remain in full force and virtue.

IN WITNESS WHEREOF, the above-bound parties have executed this instrument under their several seals on the date indicated above, the name and corporate seal of each corporate party being hereto affixed and these presents duly signed by its undersigned representative, pursuant to authority of its governing body.

**CONTRACT PERFORMANCE BOND**

*Affix Seal of Surety Company*

\_\_\_\_\_  
Print or type Surety Company Name

By \_\_\_\_\_  
Print, stamp or type name of Attorney-in-Fact

\_\_\_\_\_  
Signature of Attorney-in-Fact

\_\_\_\_\_  
Signature of Witness

\_\_\_\_\_  
Print or type Signer's name

\_\_\_\_\_  
Address of Attorney-in-Fact

**CONTRACT PERFORMANCE BOND  
CORPORATION**

SIGNATURE OF CONTRACTOR (Principal)

\_\_\_\_\_  
Full name of Corporation

\_\_\_\_\_  
Address as prequalified

By

\_\_\_\_\_  
**Signature** of President, Vice President, Assistant Vice President  
*Select appropriate title*

\_\_\_\_\_  
Print or type Signer's name

*Affix Corporate Seal*

Attest

\_\_\_\_\_  
**Signature** of Secretary, Assistant Secretary  
*Select appropriate title*

\_\_\_\_\_  
Print or type Signer's name

**CONTRACT PERFORMANCE BOND  
LIMITED LIABILITY COMPANY**

SIGNATURE OF CONTRACTOR (Principal)

Name of Contractor

\_\_\_\_\_   
Full name of Firm

\_\_\_\_\_   
Address as prequalified

By:

\_\_\_\_\_   
Signature of Member, Manager, Authorized Agent  
*Select appropriate title*

\_\_\_\_\_   
Print or type Signer's name

**CONTRACT PERFORMANCE BOND**

**INDIVIDUAL DOING BUSINESS UNDER A FIRM NAME**

SIGNATURE OF CONTRACTOR (Principal)

Name of Contractor

\_\_\_\_\_  
Individual Name

Trading and doing business as

\_\_\_\_\_  
Full name of Firm

\_\_\_\_\_  
Address as prequalified

Signature of Contractor

\_\_\_\_\_  
Individually

\_\_\_\_\_  
Print or type Signer's name

\_\_\_\_\_  
Signature of Witness

\_\_\_\_\_  
Print or type Signer's name

**CONTRACT PERFORMANCE BOND**

**INDIVIDUAL DOING BUSINESS IN HIS OWN NAME**

SIGNATURE OF CONTRACTOR (Principal)

Name of Contractor

\_\_\_\_\_
Print or type Individual name

\_\_\_\_\_
Address as prequalified

Signature of Contractor

\_\_\_\_\_
Individually

\_\_\_\_\_
Print or type Signer's name

\_\_\_\_\_
Signature of Witness

\_\_\_\_\_
Print or type Signer's name



**CONTRACT PERFORMANCE BOND  
PARTNERSHIP**

SIGNATURE OF CONTRACTOR (Principal)

---

Full name of Partnership

---

Address as prequalified

By

---

Signature of Partner

---

Print or type Signer's name

---

Signature of Witness

---

Print or type Signer's name

**CONTRACT PERFORMANCE BOND  
JOINT VENTURE (2) OR (3)  
SIGNATURE OF CONTRACTORS (Principal)**

Instructions to Bidders: 2 Joint Ventures, Fill in lines (1), (2) and (3) and execute. 3 Joint Venturers Fill in lines (1), (2), (3), (4) and execute. On Line (1), print or type the name of Joint Venture. On line (2), print or type the name of one of the joint venturers and execute below in the appropriate manner required by Article 102-8 of the *NCDOT Standard Specifications*. On Line (3), print or type the name of second joint venturer and execute below in the appropriate manner required by said article of the Specifications. On Line (4), print or type the name of the third joint venturer, if applicable and execute below in the appropriate manner required by said article of the Specifications. This form of execution must be strictly followed.

(1) \_\_\_\_\_  
Name of Joint Venture

(2) \_\_\_\_\_  
Name of Contractor

\_\_\_\_\_  
Address as prequalified

\_\_\_\_\_  
Signature of Witness or Attest By \_\_\_\_\_  
Signature of Contractor

\_\_\_\_\_  
Print or type Signer's name \_\_\_\_\_  
Print or type Signer's name

*If Corporation, affix Corporate Seal*

and

(3) \_\_\_\_\_  
Name of Contractor

\_\_\_\_\_  
Address as prequalified

\_\_\_\_\_  
Signature of Witness or Attest By \_\_\_\_\_  
Signature of Contractor

\_\_\_\_\_  
Print or type Signer's name \_\_\_\_\_  
Print or type Signer's name

*If Corporation, affix Corporate Seal*

and

(4) \_\_\_\_\_  
Name of Contractor *(for 3 Joint Venture only)*

\_\_\_\_\_  
Address as prequalified

\_\_\_\_\_  
Signature of Witness or Attest By \_\_\_\_\_  
Signature of Contractor

\_\_\_\_\_  
Print or type Signer's name \_\_\_\_\_  
Print or type Signer's name

*If Corporation, affix Corporate Seal*

**CONTRACT PERFORMANCE BOND**

Attach certified copy of Power of Attorney to this sheet

STATE OF NORTH CAROLINA  
DEPARTMENT OF TRANSPORTATION  
RALEIGH, NC

BID BOND

Principal: \_\_\_\_\_  
Name of Principal Contractor

Surety: \_\_\_\_\_  
Name of Surety

Contract Number: \_\_\_\_\_ DC00459 \_\_\_\_\_ County: Sampson County

Date of Bid: \_\_\_\_\_

KNOW ALL MEN BY THESE PRESENTS, That we, the PRINCIPAL CONTRACTOR (hereafter, PRINCIPAL) and SURETY above named, are held and firmly bound unto the Department of Transportation in the full and just sum of five (5) percent of the total amount bid by the Principal for the project stated above, for the payment of which sum well and truly to be made, we bind ourselves, our heirs, executors, administrators, and successors, jointly and severally, firmly by these presents.

NOW, THEREFORE, the condition of this obligation is: the Principal shall not withdraw its bid within sixty (60) days after the opening of the bids, or within such other time period as may be provided in the proposal, and if the Board of Transportation shall award a contract to the Principal, the Principal shall, within fourteen (14) calendar days after written notice of award is received by him, provide bonds with good and sufficient surety, as required for the faithful performance of the contract and for the protection of all persons supplying labor, material, and equipment for the prosecution of the work. In the event the Principal requests permission to withdraw his bid due to mistake in accordance with the provisions of Article 103-3 of the *Standard Specifications for Roads and Structures*, the conditions and obligations of this Bid Bond shall remain in full force and effect until the Department of Transportation makes a final determination to either allow the bid to be withdrawn or to proceed with award of the contract. In the event a determination is made to award the contract, the Principal shall have fourteen (14) calendar days to comply with the requirements set forth above. In the event the Principal withdraws its bid after bids are opened except as provided in Article 103-3, or after award of the contract has been made fails to execute such additional documents as may be required and to provide the required bonds within the time period specified above, then the amount of the bid bond shall be immediately paid to the Department of Transportation as liquidated damages.

IN TESTIMONY WHEREOF, the Principal and Surety have caused these presents to be duly signed and sealed.

This the \_\_\_\_\_ day of \_\_\_\_\_, 20 \_\_\_\_\_

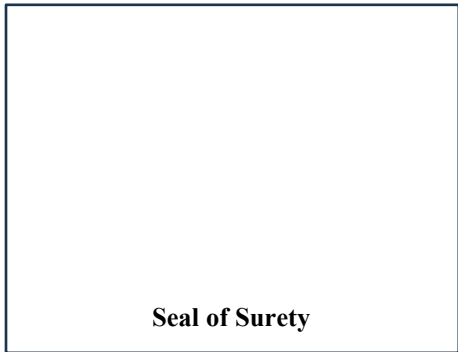

\_\_\_\_\_  
Surety

By \_\_\_\_\_  
General Agent or Attorney-in-Fact Signature

\_\_\_\_\_  
Print or Type Signer's Name

**BID BOND**

**CORPORATION**

SIGNATURE OF CONTRACTOR (Principal)

\_\_\_\_\_  
Full name of Corporation

\_\_\_\_\_  
Address as Prequalified

By \_\_\_\_\_  
Signature of President, Vice President, Assistant Vice President  
*Select appropriate title*

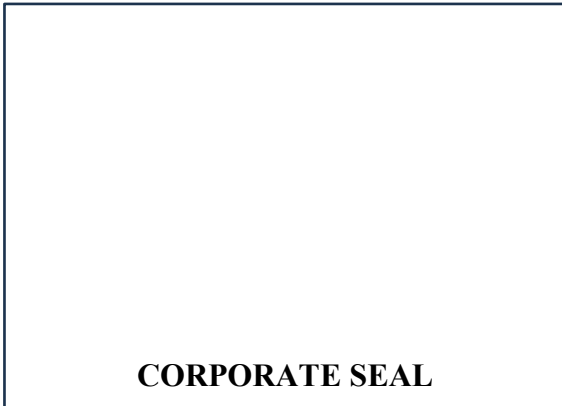

\_\_\_\_\_  
Print or Type Signer's name

Attest \_\_\_\_\_  
Signature of Secretary, Assistant Secretary  
*Select appropriate title*

\_\_\_\_\_  
Print or Type Signer's name

**BID BOND**

**LIMITED LIABILITY COMPANY**

SIGNATURE OF CONTRACTOR (Principal)

Name of Contractor

\_\_\_\_\_

Full name of Firm

\_\_\_\_\_

Address as Prequalified

**Signature of Member/  
Manager/Authorized Agent**

\_\_\_\_\_

Individually

\_\_\_\_\_

Print or Type Signer's name

**BID BOND**

**INDIVIDUAL DOING BUSINESS UNDER A FIRM NAME**

SIGNATURE OF CONTRACTOR (Principal)

Name of Contractor

\_\_\_\_\_  
Individual Name

Trading and doing business as

\_\_\_\_\_  
Full name of Firm

\_\_\_\_\_  
Address as Prequalified

Signature of Contractor

\_\_\_\_\_  
Individually

\_\_\_\_\_  
Print or Type Signer's name

\_\_\_\_\_  
Signature of Witness

\_\_\_\_\_  
Print or Type Signer's name

**BID BOND**

**INDIVIDUAL DOING BUSINESS IN HIS OWN NAME**

SIGNATURE OF CONTRACTOR (Principal)

Name of Contractor

\_\_\_\_\_

Print or type Individual Name

\_\_\_\_\_

Address as Prequalified

Signature of Contractor

\_\_\_\_\_

Individually

\_\_\_\_\_

Print or Type Signer's name

\_\_\_\_\_

Signature of Witness

\_\_\_\_\_

Print or Type Signer's name



**BID BOND**

**PARTNERSHIP**

SIGNATURE OF CONTRACTOR (Principal)

\_\_\_\_\_  
Full name of Partnership

\_\_\_\_\_  
Address as Prequalified

By \_\_\_\_\_  
Signature of Partner

\_\_\_\_\_  
Print or Type Signer's name

\_\_\_\_\_  
Signature of Witness

\_\_\_\_\_  
Print or Type Signer's name

**BID BOND**  
**JOINT VENTURE (2 or 3)**  
SIGNATURE OF CONTRACTORS (Principal)

Instructions to Bidders: **2 Joint Ventures**, Fill in lines (1), (2) and (3) and execute. **3 Joint Venturers** Fill in lines (1), (2), (3), (4) and execute. Line (1), print or type the name of Joint Venture. On line (2), print or type the name of one of the joint venturers and execute below in the appropriate manner required by Article 102-8 of the *Specifications*. On Line (3), print or type the name of second joint venturer and execute below in the appropriate manner required by said article of the Specifications. On Line (4), print or type the name of the third joint venturer, if applicable and execute below in the appropriate manner required by said article of the Specifications. This form of execution must be strictly followed.

(1) \_\_\_\_\_  
Name of Joint Venture

(2) \_\_\_\_\_  
Name of Contractor

\_\_\_\_\_  
Address as prequalified

\_\_\_\_\_  
Signature of Witness or Attest By \_\_\_\_\_  
Signature of Contractor

\_\_\_\_\_  
Print or type Signer's name \_\_\_\_\_  
*If Corporation, affix Corporate Seal* Print or type Signer's name

and

(3) \_\_\_\_\_  
Name of Contractor

\_\_\_\_\_  
Address as prequalified

\_\_\_\_\_  
Signature of Witness or Attest By \_\_\_\_\_  
Signature of Contractor

\_\_\_\_\_  
Print or type Signer's name \_\_\_\_\_  
*If Corporation, affix Corporate Seal* Print or type Signer's name

and

(4) \_\_\_\_\_  
Name of Contractor *(for 3 Joint Venture only)*

\_\_\_\_\_  
Address as prequalified

\_\_\_\_\_  
Signature of Witness or Attest By \_\_\_\_\_  
Signature of Contractor

\_\_\_\_\_  
Print or type Signer's name \_\_\_\_\_  
*If Corporation, affix Corporate Seal* Print or type Signer's name

**CORPORATE SEALS(S)**

**ADDENDA**

ADDENDUM #1

I, \_\_\_\_\_ representing \_\_\_\_\_  
(SIGNATURE)

Acknowledge receipt of Addendum #1.

ADDENDUM #2

I, \_\_\_\_\_ representing \_\_\_\_\_  
(SIGNATURE)

Acknowledge receipt of Addendum #2.

ADDENDUM #3

I, \_\_\_\_\_ representing \_\_\_\_\_  
(SIGNATURE)

Acknowledge receipt of Addendum #3.

**NON-COLLUSION, DEBARMENT AND GIFT BAN CERTIFICATION**

**CORPORATION**

The prequalified bidder being duly sworn, solemnly swears (or affirms) that neither he, nor any official, agent or employee has entered into any agreement, participated in any collusion, or otherwise taken any action which is in restraint of free competitive bidding in connection with any bid or contract, that the prequalified bidder has not been convicted of violating N.C.G.S. §133-24 within the last three years, and that the prequalified bidder intends to do the work with his own bona fide employees or subcontractors and will not bid for the benefit of another contractor.

By submitting this non-collusion, debarment and gift ban certification, the Contractor is attesting his status under penalty of perjury under the laws of the United States in accordance with the Debarment Certification attached, provided that the Debarment Certification also includes any required statements concerning exceptions that are applicable.

N.C.G.S. §133-32 and Executive Order 24 prohibit the offer to, or acceptance by, any State Employee of any gift from anyone with a contract with the State, or from any person seeking to do business with the State. By execution of any response in this procurement, you attest, for your entire organization and its employees or agents, that you are not aware that any such gift has been offered, accepted, or promised by any employees of your organization.

**SIGNATURE OF PREQUALIFIED BIDDER**

\_\_\_\_\_  
Full name of Corporation

\_\_\_\_\_  
Address as Prequalified

Attest \_\_\_\_\_  
Secretary/Assistant Secretary  
(Select appropriate title)

By \_\_\_\_\_  
President/Vice President/Assistant Vice President  
(Select appropriate title)

\_\_\_\_\_  
Print or Type Signer's name

\_\_\_\_\_  
Print or Type Signer's name



**NON-COLLUSION, DEBARMENT AND GIFT BAN CERTIFICATION**

**PARTNERSHIP**

The prequalified bidder, being duly sworn, solemnly swears (or affirms) that neither he, nor any official, agent or employee has entered into any agreement, participated in any collusion, or otherwise taken any action which is in restraint of free competitive bidding in connection with any bid or contract, that the prequalified bidder has not been convicted of violating *N.C.G.S. § 133-24* within the last three years, and that the prequalified bidder intends to do the work with its own bona fide employees or subcontractors and will not bid for the benefit of another contractor.

By submitting this non-collusion, debarment and gift ban certification, the Contractor is attesting his status under penalty of perjury under the laws of the United States in accordance with the Debarment Certification attached, provided that the Debarment Certification also includes any required statements concerning exceptions that are applicable.

*N.C.G.S. § 133-32* and Executive Order 24 prohibit the offer to, or acceptance by, any State Employee of any gift from anyone with a contract with the State, or from any person seeking to do business with the State. By execution of any response in this procurement, you attest, for your entire organization and its employees or agents, that you are not aware that any such gift has been offered, accepted, or promised by any employees of your organization.

**SIGNATURE OF PREQUALIFIED BIDDER**

\_\_\_\_\_  
Full Name of  
Partnership

\_\_\_\_\_  
Address as  
Prequalified

\_\_\_\_\_  
Signature of Witness

\_\_\_\_\_  
Signature of Partner

\_\_\_\_\_  
Print or Type Signer's Name

\_\_\_\_\_  
Print or Type Signer's Name

**NON-COLLUSION, DEBARMENT AND GIFT BAN CERTIFICATION**

**LIMITED LIABILITY COMPANY**

The prequalified bidder, being duly sworn, solemnly swears (or affirms) that neither he, nor any official, agent or employee has entered into any agreement, participated in any collusion, or otherwise taken any action which is in restraint of free competitive bidding in connection with any bid or contract, that the prequalified bidder has not been convicted of violating *N.C.G.S. § 133-24* within the last three years, and that the prequalified bidder intends to do the work with its own bona fide employees or subcontractors and will not bid for the benefit of another contractor.

By submitting this non-collusion, debarment and gift ban certification, the Contractor is attesting his status under penalty of perjury under the laws of the United States in accordance with the Debarment Certification attached, provided that the Debarment Certification also includes any required statements concerning exceptions that are applicable.

*N.C.G.S. § 133-32* and Executive Order 24 prohibit the offer to, or acceptance by, any State Employee of any gift from anyone with a contract with the State, or from any person seeking to do business with the State. By execution of any response in this procurement, you attest, for your entire organization and its employees or agents, that you are not aware that any such gift has been offered, accepted, or promised by any employees of your organization.

**SIGNATURE OF PREQUALIFIED BIDDER**

\_\_\_\_\_

Full Name of Firm

\_\_\_\_\_

Address as Prequalified

\_\_\_\_\_  
Signature of Witness

\_\_\_\_\_  
Signature of Member/Manager/Authorized Agent  
*(Select appropriate Title)*

\_\_\_\_\_  
Print or Type Signer's Name

\_\_\_\_\_  
Print or Type Signer's Name

**NON-COLLUSION, DEBARMENT AND GIFT BAN CERTIFICATION**

**JOINT VENTURE (2) or (3)**

The prequalified bidder, being duly sworn, solemnly swears (or affirms) that neither he, nor any official, agent or employee has entered into any agreement, participated in any collusion, or otherwise taken any action which is in restraint of free competitive bidding in connection with any bid or contract, that the prequalified bidder has not been convicted of violating *N.C.G.S. § 133-24* within the last three years, and that the prequalified bidder intends to do the work with its own bona fide employees or subcontractors and will not bid for the benefit of another contractor.

By submitting this non-collusion, debarment and gift ban certification, the Contractor is attesting his status under penalty of perjury under the laws of the United States in accordance with the Debarment Certification attached, provided that the Debarment Certification also includes any required statements concerning exceptions that are applicable.

*N.C.G.S. § 133-32* and Executive Order 24 prohibit the offer to, or acceptance by, any State Employee of any gift from anyone with a contract with the State, or from any person seeking to do business with the State. By execution of any response in this procurement, you attest, for your entire organization and its employees or agents, that you are not aware that any such gift has been offered, accepted, or promised by any employees of your organization.

**SIGNATURE OF PREQUALIFIED BIDDER**

Instructions: **2 Joint Venturers** Fill in lines (1), (2) and (3) and execute. **3 Joint Venturers** Fill in lines (1), (2), (3) and (4) and execute. On Line (1), fill in the name of the Joint Venture Company. On Line (2), fill in the name of one of the joint venturers and execute below in the appropriate manner. On Line (3), print or type the name of the other joint venturer and execute below in the appropriate manner. On Line (4), fill in the name of the third joint venturer, if applicable and execute below in the appropriate manner.

(1) \_\_\_\_\_  
Name of Joint Venture

(2) \_\_\_\_\_  
Name of Contractor

\_\_\_\_\_  
Address as Prequalified

\_\_\_\_\_  
Signature of Witness or Attest

 BY \_\_\_\_\_  
Signature of Contractor

\_\_\_\_\_  
Print or Type Signer's Name

 AND \_\_\_\_\_  
*If Corporation, affix Corporate Seal* Print or Type Signer's Name

(3) \_\_\_\_\_  
Name of Contractor

\_\_\_\_\_  
Address as Prequalified

\_\_\_\_\_  
Signature of Witness or Attest

 BY \_\_\_\_\_  
Signature of Contractor

\_\_\_\_\_  
Print or Type Signer's Name

 AND \_\_\_\_\_  
*If Corporation, affix Corporate Seal* Print or Type Signer's Name

(4) \_\_\_\_\_  
Name of Contractor

\_\_\_\_\_  
Address as Prequalified

\_\_\_\_\_  
Signature of Witness or Attest

 BY \_\_\_\_\_  
Signature of Contractor

\_\_\_\_\_  
Print or Type Signer's Name

 \_\_\_\_\_  
*If Corporation, affix Corporate Seal* Print or Type Signer's Name

CORPORATE SEAL(S)

**NON-COLLUSION, DEBARMENT AND GIFT BAN CERTIFICATION**

**INDIVIDUAL DOING BUSINESS UNDER A FIRM NAME**

The prequalified bidder, being duly sworn, solemnly swears (or affirms) that neither he, nor any official, agent or employee has entered into any agreement, participated in any collusion, or otherwise taken any action which is in restraint of free competitive bidding in connection with any bid or contract, that the prequalified bidder has not been convicted of violating *N.C.G.S. § 133-24* within the last three years, and that the prequalified bidder intends to do the work with its own bona fide employees or subcontractors and will not bid for the benefit of another contractor.

By submitting this non-collusion, debarment and gift ban certification, the Contractor is attesting his status under penalty of perjury under the laws of the United States in accordance with the Debarment Certification attached, provided that the Debarment Certification also includes any required statements concerning exceptions that are applicable.

*N.C.G.S. § 133-32* and Executive Order 24 prohibit the offer to, or acceptance by, any State Employee of any gift from anyone with a contract with the State, or from any person seeking to do business with the State. By execution of any response in this procurement, you attest, for your entire organization and its employees or agents, that you are not aware that any such gift has been offered, accepted, or promised by any employees of your organization.

**SIGNATURE OF PREQUALIFIED BIDDER**

Name of Prequalified Bidder

\_\_\_\_\_  
Individual Name

Trading and Doing Business As

\_\_\_\_\_  
Full name of Firm

\_\_\_\_\_  
Address as Prequalified

\_\_\_\_\_  
Signature of Witness

\_\_\_\_\_  
Signature of Prequalified Bidder, Individual

\_\_\_\_\_  
Print or Type Signer's Name

\_\_\_\_\_  
Print or Type Signer's Name



**NON-COLLUSION, DEBARMENT GIFT BAN CERTIFICATION**

**INDIVIDUAL DOING BUSINESS IN HIS OWN NAME**

The prequalified bidder, being duly sworn, solemnly swears (or affirms) that neither he, nor any official, agent or employee has entered into any agreement, participated in any collusion, or otherwise taken any action which is in restraint of free competitive bidding in connection with any bid or contract, that the prequalified bidder has not been convicted of violating *N.C.G.S. § 133-24* within the last three years, and that the prequalified bidder intends to do the work with its own bona fide employees or subcontractors and will not bid for the benefit of another contractor.

By submitting this non-collusion, debarment and gift ban certification, the Contractor is attesting his status under penalty of perjury under the laws of the United States in accordance with the Debarment Certification attached, provided that the Debarment Certification also includes any required statements concerning exceptions that are applicable.

*N.C.G.S. § 133-32* and Executive Order 24 prohibit the offer to, or acceptance by, any State Employee of any gift from anyone with a contract with the State, or from any person seeking to do business with the State. By execution of any response in this procurement, you attest, for your entire organization and its employees or agents, that you are not aware that any such gift has been offered, accepted, or promised by any employees of your organization.

**SIGNATURE OF PREQUALIFIED BIDDER**

Name of Prequalified Bidder \_\_\_\_\_  
Print or Type Name

\_\_\_\_\_  
Address as Prequalified

\_\_\_\_\_  
Signature of Prequalified Bidder, Individually

\_\_\_\_\_  
Print or Type Signer's Name

\_\_\_\_\_  
Signature of Witness

\_\_\_\_\_  
Print or Type Signer's name

**DEBARMENT CERTIFICATION**

Conditions for certification:

1. The prequalified bidder shall provide immediate written notice to the Department if at any time the bidder learns that his certification was erroneous when he submitted his debarment certification or explanation that is file with the Department, or has become erroneous because of changed circumstances.
2. The terms *covered transaction, debarred, suspended, ineligible, lower tier covered transaction, participant, person, primary covered transaction, principal, proposal, and voluntarily excluded*, as used in this provision, have the meanings set out in the Definitions and Coverage sections of the rules implementing Executive Order 12549. A copy of the Federal Rules requiring this certification and detailing the definitions and coverages may be obtained from the Contract Officer of the Department.
3. The prequalified bidder agrees by submitting this form, that he will not knowingly enter into any lower tier covered transaction with a person who is debarred, suspended, declared ineligible, or voluntarily excluded from participation in NCDOT contracts, unless authorized by the Department.
4. For Federal Aid projects, the prequalified bidder further agrees that by submitting this form he will include the Federal-Aid Provision titled *Required Contract Provisions Federal-Aid Construction Contract (Form FHWA PR 1273)* provided by the Department, without subsequent modification, in all lower tier covered transactions.
5. The prequalified bidder may rely upon a certification of a participant in a lower tier covered transaction that he is not debarred, suspended, ineligible, or voluntarily excluded from the covered transaction, unless he knows that the certification is erroneous. The bidder may decide the method and frequency by which he will determine the eligibility of his subcontractors.
6. Nothing contained in the foregoing shall be construed to require establishment of a system of records in order to render in good faith the certification required by this provision. The knowledge and information of a participant is not required to exceed that which is normally possessed by a prudent person in the ordinary course of business dealings.
7. Except as authorized in paragraph 6 herein, the Department may terminate any contract if the bidder knowingly enters into a lower tier covered transaction with a person who is suspended, debarred, ineligible, or voluntarily excluded from participation in this transaction, in addition to other remedies available by the Federal Government.

**DEBARMENT CERTIFICATION**

The prequalified bidder certifies to the best of his knowledge and belief, that he and his principals:

- a. Are not presently debarred, suspended, proposed for debarment, declared ineligible, or voluntarily excluded from covered transactions by any Federal department or agency;
- b. Have not within a three-year period preceding this proposal been convicted of or had a civil judgment rendered against them for commission of fraud or a criminal offense in connection with obtaining, attempting to obtain, or performing a public (Federal, State or local) transaction or contract under a public transaction; violation of Federal or State antitrust statutes or commission of embezzlement, theft, forgery, bribery, falsification or destruction of records; making false statements; or receiving stolen property;
- c. Are not presently indicted for or otherwise criminally or civilly charged by a governmental entity (Federal, State or local) with commission of any of the offenses enumerated in paragraph b. of this certification; and
- d. Have not within a three-year period preceding this proposal had one or more public transactions (Federal, State or local) terminated for cause or default.
- e. Will submit a revised Debarment Certification immediately if his status changes and will show in his bid proposal an explanation for the change in status.

If the prequalified bidder cannot certify that he is not debarred, he shall provide an explanation with this submittal. An explanation will not necessarily result in denial of participation in a contract.

Failure to submit a non-collusion affidavit and debarment certification will result in the prequalified bidder's bid being considered non-responsive.

Check here if an explanation is attached to this certification.

County: SAMPSON

Line #	Item Number	Sec #	Description	Quantity	Unit Cost	Amount
ROADWAY ITEMS						
0001	0000100000-N	800	MOBILIZATION	Lump Sum	L.S.	
0002	0000400000-N	801	CONSTRUCTION SURVEYING	Lump Sum	L.S.	
0003	0036000000-E	225	UNDERCUT EXCAVATION	300 CY		
0004	0043000000-N	226	GRADING	Lump Sum	L.S.	
0005	0195000000-E	265	SELECT GRANULAR MATERIAL	300 CY		
0006	0196000000-E	270	GEOTEXTILE FOR SOIL STABILIZATION	300 SY		
0007	0223000000-E	275	ROCK PLATING	260 SY		
0008	0248000000-N	SP	GENERIC GRADING ITEM TYPE I BRIDGE APPROACH FILL, STA. 17+25.50	Lump Sum	L.S.	
0009	0318000000-E	300	FOUNDATION CONDITIONING MATERIAL, MINOR STRUCTURES	10 TON		
0010	0321000000-E	300	FOUNDATION CONDITIONING GEOTEXTILE	30 SY		
0011	0335200000-E	305	15" DRAINAGE PIPE	80 LF		
0012	0335850000-E	305	*** DRAINAGE PIPE ELBOWS (15")	8 EA		
0013	1220000000-E	545	INCIDENTAL STONE BASE	25 TON		
0014	1491000000-E	610	ASPHALT CONC BASE COURSE, TYPE B25.0C	340 TON		
0015	1503000000-E	610	ASPHALT CONC INTERMEDIATE COURSE, TYPE I19.0C	330 TON		
0016	1519000000-E	610	ASPHALT CONC SURFACE COURSE, TYPE S9.5B	370 TON		
0017	1575000000-E	620	ASPHALT BINDER FOR PLANT MIX	60 TON		

County: SAMPSON

Line #	Item Number	Sec #	Description	Quantity	Unit Cost	Amount
0018	2022000000-E	815	SUBDRAIN EXCAVATION	44.8 CY		
0019	2026000000-E	815	GEOTEXTILE FOR SUBSURFACE DRAINS	200 SY		
0020	2036000000-E	815	SUBDRAIN COARSE AGGREGATE	33.6 CY		
0021	2044000000-E	815	6" PERFORATED SUBDRAIN PIPE	200 LF		
0022	2070000000-N	815	SUBDRAIN PIPE OUTLET	1 EA		
0023	2077000000-E	815	6" OUTLET PIPE	6 LF		
0024	2286000000-N	840	MASONRY DRAINAGE STRUCTURES	4 EA		
0025	2367000000-N	840	FRAME WITH TWO GRATES, STD 840.29	4 EA		
0026	2556000000-E	846	SHOULDER BERM GUTTER	240 LF		
0027	3030000000-E	862	STEEL BEAM GUARDRAIL	412.5 LF		
0028	3150000000-N	862	ADDITIONAL GUARDRAIL POSTS	10 EA		
0029	3215000000-N	862	GUARDRAIL ANCHOR UNITS, TYPE III	4 EA		
0030	3287000000-N	862	GUARDRAIL END UNITS, TYPE TL-3	4 EA		
0031	3635000000-E	876	RIP RAP, CLASS II	40 TON		
0032	3649000000-E	876	RIP RAP, CLASS B	4 TON		
0033	3656000000-E	876	GEOTEXTILE FOR DRAINAGE	450 SY		
0034	4072000000-E	903	SUPPORTS, 3-LB STEEL U-CHANNEL	31.5 LF		

County: SAMPSON

Line #	Item Number	Sec #	Description	Quantity	Unit Cost	Amount
0035	4096000000-N	904	SIGN ERECTION, TYPE D	1 EA		
0036	4155000000-N	907	DISPOSAL OF SIGN SYSTEM, U-CHANNEL	6 EA		
0037	4192000000-N	907	DISPOSAL OF SUPPORT, U-CHANNEL	1 EA		
0038	4400000000-E	1110	WORK ZONE SIGNS (STATIONARY)	391 SF		
0039	4410000000-E	1110	WORK ZONE SIGNS (BARRICADE MOUNTED)	119 SF		
0040	4422000000-N	1120	PORTABLE CHANGEABLE MESSAGE SIGN (SHORT TERM)	28 DAY		
0041	4445000000-E	1145	BARRICADES (TYPE III)	96 LF		
0042	4685000000-E	1205	THERMOPLASTIC PAVEMENT MARKING LINES (4", 90 MILS)	1,996 LF		
0043	4900000000-N	1251	PERMANENT RAISED PAVEMENT MARKERS	7 EA		
0044	6000000000-E	1605	TEMPORARY SILT FENCE	1,235 LF		
0045	6006000000-E	1610	STONE FOR EROSION CONTROL, CLASS A	75 TON		
0046	6012000000-E	1610	SEDIMENT CONTROL STONE	125 TON		
0047	6015000000-E	1615	TEMPORARY MULCHING	2 ACR		
0048	6018000000-E	1620	SEED FOR TEMPORARY SEEDING	200 LB		
0049	6021000000-E	1620	FERTILIZER FOR TEMPORARY SEEDING	1 TON		
0050	6024000000-E	1622	TEMPORARY SLOPE DRAINS	200 LF		
0051	6029000000-E	SP	SAFETY FENCE	720 LF		

County: SAMPSON

Line #	Item Number	Sec #	Description	Quantity	Unit Cost	Amount
0052	6036000000-E	1631	MATTING FOR EROSION CONTROL	1,930 SY		
0053	6037000000-E	1629	COIR FIBER MAT	100 SY		
0054	6042000000-E	1632	1/4" HARDWARE CLOTH	385 LF		
0055	6048000000-E	SP	FLOATING TURBIDITY CURTAIN	220 SY		
0056	6070000000-N	1639	SPECIAL STILLING BASINS	2 EA		
0057	6071014000-E	1642	COIR FIBER WATTLE BARRIER	110 LF		
0058	6084000000-E	1660	SEEDING & MULCHING	3 ACR		
0059	6087000000-E	1660	MOWING	3 ACR		
0060	6090000000-E	1661	SEED FOR REPAIR SEEDING	50 LB		
0061	6093000000-E	1661	FERTILIZER FOR REPAIR SEEDING	0.25 TON		
0062	6096000000-E	1662	SEED FOR SUPPLEMENTAL SEEDING	50 LB		
0063	6108000000-E	1665	FERTILIZER TOPDRESSING	1.25 TON		
0064	6111000000-E	SP	IMPERVIOUS DIKE	130 LF		
0065	6114500000-N	1667	SPECIALIZED HAND MOWING	10 MHR		
0066	6117000000-N	1675	RESPONSE FOR EROSION CONTROL	25 EA		
0067	6117500000-N	SP	CONCRETE WASHOUT STRUCTURE	2 EA		
0068	6132000000-N	SP	GENERIC EROSION CONTROL ITEM FABRIC INSERT INLET PROTECTION	6 EA		

County: SAMPSON

Line #	Item Number	Sec #	Description	Quantity	Unit Cost	Amount
0069	6132000000-N	SP	GENERIC EROSION CONTROL ITEM FABRIC INSERT INLET PROTECTION CLEANOUT	18 EA		
-----						
STRUCTURE ITEMS						
0070	8035000000-N	402	REMOVAL OF EXISTING STRUCTURE AT STATION ***** (17+25.50 -L-)	Lump Sum	L.S.	
0071	8065000000-N	SP	ASBESTOS ASSESSMENT	Lump Sum	L.S.	
0072	8121000000-N	412	UNCLASSIFIED STRUCTURE EXCAVATION AT STATION ***** (17+25.50 -L-)	Lump Sum	L.S.	
0073	8182000000-E	420	CLASS A CONCRETE (BRIDGE)	53.9 CY		
0074	8210000000-N	422	BRIDGE APPROACH SLABS, STATION ***** (17+25.50 -L-)	Lump Sum	L.S.	
0075	8217000000-E	425	REINFORCING STEEL (BRIDGE)	7,408 LB		
0076	8328200000-E	450	PILE DRIVING EQUIPMENT SETUP FOR *** STEEL PILES (HP 12X53)	14 EA		
0077	8328400000-E	450	PILE DRIVING EQUIPMENT SETUP FOR *** GALVANIZED STEEL PILES (HP 14X73)	8 EA		
0078	8364000000-E	450	HP 12 X 53 STEEL PILES	735 LF		
0079	8384200000-E	450	HP 14 X 73 GALVANIZED STEEL PILES	480 LF		
0080	8393000000-N	450	PILE REDRIVES	11 EA		
0081	8394000000-N	450	DYNAMIC PILE TESTING	2 EA		
0082	8505000000-E	460	VERTICAL CONCRETE BARRIER RAIL	220.5 LF		
0083	8608000000-E	876	RIP RAP CLASS II (2'-0" THICK)	241 TON		



County: SAMPSON

Line #	Item Number	Sec #	Description	Quantity	Unit Cost	Amount
0084	8622000000-E	876	GEOTEXTILE FOR DRAINAGE	267 SY		
0085	8657000000-N	430	ELASTOMERIC BEARINGS	Lump Sum	L.S.	
0086	8762000000-E	430	3'-0" X 1'-9" PRESTRESSED CONC CORED SLABS	1,210 LF		

0825/May22/Q23010.3/D396329364000/E86

Total Amount Of Bid For Entire Project :